

584

GENERAL SOCIETY of MECHANICS and TRADESMEN
MECHANICS INSTITUTE
LIBRARY DEPARTMENT

 Readers are forbidden to **MUTILATE** this slip. If lost or defaced, a penalty of **TEN CENTS** will be imposed.

DATE	FOLIO
NOV - 3 1955	

WITHDRAWN
MSMA



THE WORLD ON WHEELS
AND ITS ASSOCIATIONS.

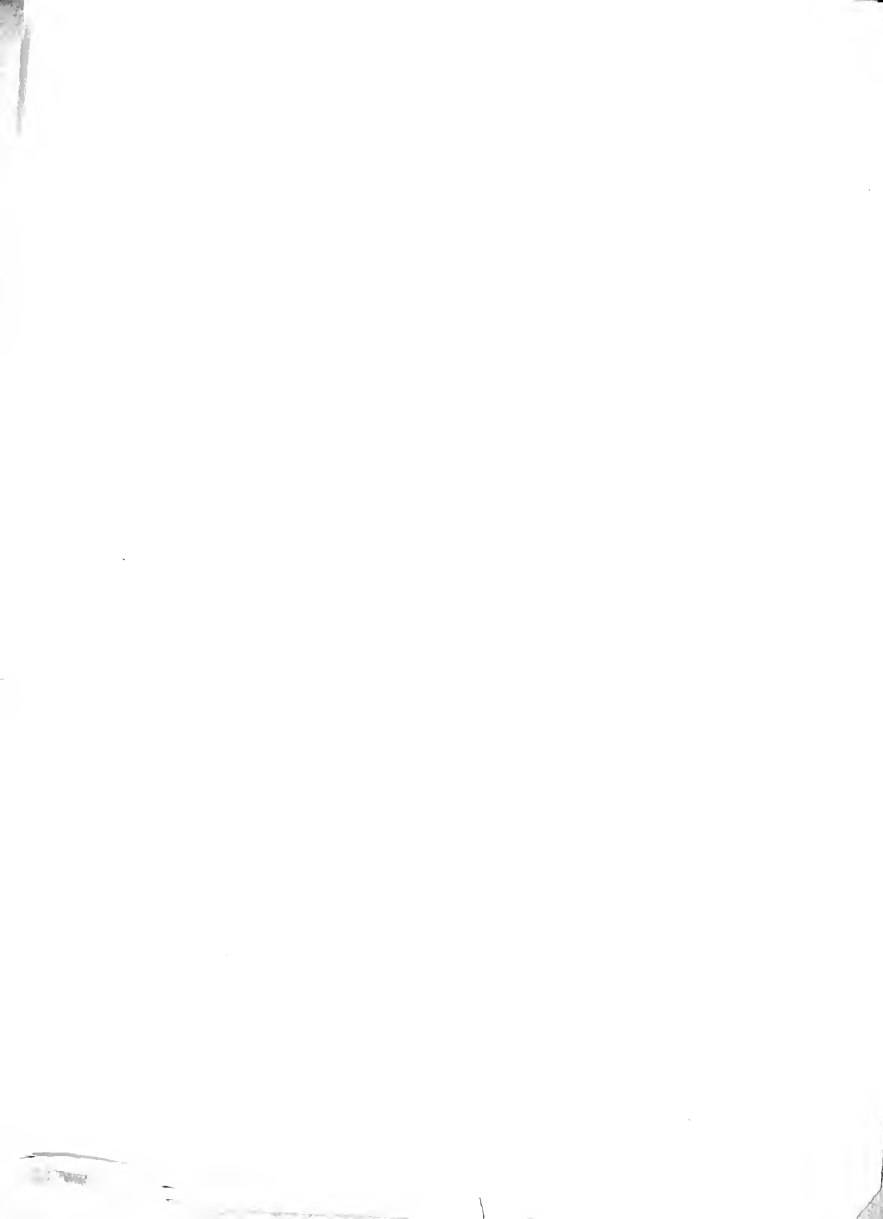





LEONARD BROWN

AN OUTSIDE BARBARIAN AMONG THE CELESTIALS.

THE WORLD ON WHEELS;

OR,

CARRIAGES,

WITH THEIR

HISTORICAL ASSOCIATIONS FROM THE EARLIEST TO
THE PRESENT TIME,

INCLUDING

A SELECTION FROM THE AMERICAN CENTENNIAL EXHIBITION.



BY

EZRA M. STRATTON,

PRACTICAL CARRIAGE-BUILDER, EDITOR OF THE "NEW YORK COACH-MAKER'S MAGAZINE," AND
HONORARY MEMBER OF THE CARRIAGE-BUILDERS' NATIONAL ASSOCIATION.

WITH

Nearly Four Hundred Illustrations.

Handwritten initials and number: 8755

Handwritten text: Ut / 1881 / w

"This is the rattling, rowing, rumbling age, and the World runs on Wheels."
TAYLOR, *The Water Poet*.

NEW YORK:
PUBLISHED BY THE AUTHOR,
325 EAST EIGHTHENTH STREET.
1878.

COPYRIGHT:
BY EZRA M. STRATTON,
A. D. 1878.

TO
ALL ADMIRERS AND LOVERS
OF THE
COACH-MAKER'S HANDIWORK IN ALL LANDS,

This Volume

IS MOST SINCERELY INSCRIBED BY

THE AUTHOR.

P R E F A C E .

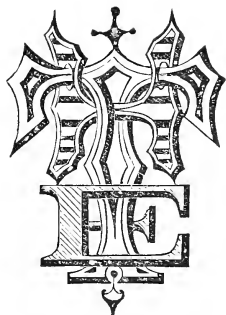

EARLIEST allusion to wheel-carriages is found in the Book of Genesis, where Pharaoh commands his prime minister, saying, "Take you wagons [chariots?] out of the land of Egypt, for your little ones and for your wives, and come." More than thirty-five centuries have since passed away, during which carriages, under a multitude of forms, have rendered man important service, either in business, for his comfort, or at his decease. More than this, they have served as thermometers in recording the rise or fall of civilization in every stage of its progress. To point out how they have persistently *pushed* their way through opposition from fierce enmity to present popularity has been a potent incentive to the compilation of this volume.

Several attempts have heretofore been made to write the history of carriages, generally limited in the treatment, or chiefly confined to mechanical instruction, of very little interest to general readers. The *cream* of some of these, a study of years, *con amore*, added to the experience of a lifetime, has here for the first time been collected for the special benefit and amusement of all lovers of the coach-maker's

handiwork. The numerous illustrations, drawn on the block from the author's designs or reduced native originals, by our son, E. Washington Stratton, serve to show the progress and condition of art in different countries much more effectually than could be done in the most finished essay under any circumstances. If in outline some of these seem at variance with Hogarth's "line of beauty," we trust the public will still accept them as a sacrifice we have been compelled to offer at the shrine of historical impartiality and undisguised truthfulness.

In addition to the kindness of friends elsewhere acknowledged in this volume, the author would mention with special thanks Messrs. George M. Hooper & Co., of London, Coach-makers to the Queen and H. R. H. the Prince of Wales, for a variety of favors; and T. Farmer Baily, Esq., Sunnyside, Ryde, Isle of Wight, for the liberal use of his scrap-book, "Collection of Coaches," recently on exhibition in the South Kensington Museum, London, without which much of the interest given to this work would have been lost.

A handwritten signature in cursive script, reading "Ezra M. Stratton". The signature is written in dark ink and features a prominent, sweeping flourish that extends horizontally across the bottom of the name.

NEW YORK, *March 27*, 1878.

TABLE OF CONTENTS.

CHAPTER I.

EGYPTIAN. — Man's necessities the primary cause of inventive action. — The lower animals subjugated by him. — The sledge an inceptive idea in coach-making. — Egyptians the inventors of chariots. — Egyptian funeral ceremonies and early use of the sledge. — Improved sledge-wagon. — A leaf from the history of Menepthah I, whereon are described the ceremonies attendant upon the surrender of an enemy to the victor. — The chariot and furniture described. — General remarks concerning the bass-reliefs found on monuments. — Sketches of the life of Rameses II, showing the cruelties of the Egyptians. — Egyptian horse-blankets and yokes. — Carts of the Tokkari. — Conquests of Rameses III in Central Africa and portions of Asia. — Chariots of the period, their beauties and defects examined. — The reigns of Menepthah II and III. — Military organizations of the Egyptians. — Baggage-cart. — Ceremonies observed in honor of Amun. — Hunting as pursued by the Egyptians. — Rameses IV and his deeds as recorded in the Temple at Luxor. — Description of a chariot in the Florentine Museum, and the fragments of another in the New York Historical Society's Collection. — Extracts in praise of the horse. — Illustrations showing the different modes of building chariots in Egypt Pages 17-68

CHAPTER II.

ASSYRIAN. — The reclaimed treasures of Assyrian art preserved in the Louvre and British Museum. — Probable introduction of chariots into Assyria by the invading army of Sesostris. — Water transportation of the king's army. — Reasons for the chronology adopted in this chapter. — Comparison of Egyptian with Assyrian rules of scientific art. — Peace treaty with an enemy. — The monarch of Assyria hunting the monarch of the jungle. — Critical examination of Assyrian chariots. — Thorn in the lion's tail. — Chariot from Khorsabad in a battle-scene. — Assyrian horse-trappings. — Chariots of gold, silver, and costly woods. — Probable use of iron wheels. — The king's wheel-chair borne on the shoulders of eunuchs. — Chariots captured from an enemy. — Sennacherib in a chariot before Lachish, guarded by soldiers. — Harness of the Assyrians. — Conjectural chariots of the Trojans. — Was art among the Assyrians of home growth, or was it imported from Egypt? — Elamitish, Armenian, and Susianian carts, drawn by horses, mules, and oxen, taken by "the great king" in battle Pages 69-92

CHAPTER III.

PERSIAN. — Assyrian character of the earlier Persepolitan vehicles. — Bass-reliefs found at Persepolis, representing chariots. — Persian belief in auguries. — Idol-car from Persepolis. — Scythe-chariots in the army of Ninus. — Cyrus abolishes the

old chariots, and invents new ones with scythes.—Xenophon's description of scythe-chariots.—Abradatus adds four perches, which induces Cyrus to build a chariot with eight.—Scythe-chariots proved failures in an encounter with Egyptian soldiers.—Curtius describes an encounter between Alexander and Darius.—LeClere's criticism of Curtius on scythe-chariots, in which he indorses the speculations of John Scheffer.—Livy and Diodorus on hooked chariots.—Labors of Scheffer to reconcile Curtius to "common-sense."—Ginzrot pronounces the *savans* at fault, owing to a defective education in carriage-building, and animadverts on the ignorance of Vegetius, Stechevius, and others.—Scythe-chariots fail when tried against the legions of Alexander.—The barbarians under Porus meet Alexander in India.—Alexander by strategy defeats the Thracian object with chariots.—Pharmaces attacks Cæsar's army with scythe-chariots near Zicla, and is beaten.—The *currus-falcatus* of Antiochus.—Scythe-chariots despised by Alexander Severus.—Persian harmanaxa, used by the ladies.—Description of Alexander's state funeral-car.—Modern farmer's cart Pages 93-115

CHAPTER IV.

GRECIAN.—Invention of chariots ascribed to Mars and others, Erichthonius being credited with first using four horses to vehicles.—General employment of vehicles throughout Greece.—Materials used in the construction of diphrons.—Plato's description of a chariot.—Grecian trophy in the Vatican Museum.—Spoils of victory dedicated to the gods.—Unfaithfulness of Myrtilus, the charioteer of Ænomaus.—Chariot-races in the Olympian games.—Contested by kings.—Cynisca a victor in the chariot-race.—Nestor's instructions to Antilochus.—Amnicæus, a skillful driver, experiments before Plato and his scholars.—Poetical description of a chariot-race.—Chariot of Eos.—Curious picture from a vase.—Flight of Priam from Troy.—Mars and his bloody work.—Chariots in use by the females of Greece.—Homeric chariot-building.—Hesiod on felling timber.—Bass-reliefs from Mycenæ.—Etruscan chariots from the vases, similar to the Grecian Pages 116-136

CHAPTER V.

ROMAN.—Royal highways all leading to Rome.—Early introduction of the lectica into the empire from the East, followed by the basterna, a slow mode of travel.—Carpentum and its special uses.—Messalina brings it into disgrace.—Carpentum Pompaticum, or state-carriage.—Pilentum popular in sacred processions.—Cisium, the post-coach, stigmatized as the "gallant's carriage."—Monachus, the lady's pony-phaeton.—The biroton.—The arcera.—The carrus, called by Cæsar a plaustrum, in use by the Helvetians.—Difference between the currus and plaustrum explained; how constructed and employed.—Dogs attendant on oxen.—Planstra majora, postellum, curriculum, and pegma.—Chariots, how distinguished in the Vatican Museum.—Poles, yokes, etc.—Bigas.—Circus Maximus and the race-course.—Royal punishment for free opinions.—Nero a charioteer.—Costume in the race.—Upset quadriga.—Virgil's description of the race.—Wild animals trained for the circens.—Triumphs of Paulus Æmilius and of Titus.—Cremation.—A sportsman's funeral.—Rhedas described.—Vehicula meritoria.—Carruca.—Authors on the Thensa.—The "rustic" benna.—Names of Roman vehicles.—Carriage-part.—Odometer.—Myrmecides' carriage and horses "no larger than a fly."—Modern Roman carriages Pages 137-182

CHAPTER VI.

ITALIAN. — Our knowledge of carriage-building at Pompeii dependent on the truthfulness of painters. — Chariot of victory. — Parrot car in charge of a locust. — Funeral elegy over Corinna's parrot. — Cupid as charioteer for his mother's swan team. — Lion and tiger team managed by Love. — Griffin and butterfly, typifying strength and weakness. — Mixed team. — Apollo's car and griffin team. — Plostellum from Herculaneum. — Minerva mounts her car as "the slayer of heroic men." — Love with a swan-necked car. — Diana's deer team. — Goat team from the Temple of the Dioscuri. — Bigas from Herculaneum. — Ludicrous chariot-race. — Plaustrum. — Pompeian wine-wagon. — Pompeian carriage-road. — Carroccio of the Lombards. — Italian cochio. — Neapolitan sedans and carriages in immense numbers. — The calesso Pages 183-199

CHAPTER VII.

ORIENTAL. — Chinese sedan traveling. — Cab. — Chinese carriage drawings, by a native artist. — Single omnibus in the empire. — Japanese jiu-eik-sha. — Indian hecca. — Gujerat village-cart — Bullock transit carriage. — Travel in India. — Car of Juggernaut. — Scythian movable houses. — Tartar cart. — Singular Scythian funeral rites. — Tartar cart music Pages 200-209

CHAPTER VIII.

FRENCH. — What nation invented coaches? — How were they introduced into Europe? Citizens' wives forbidden to use carriages. — Oldest Gallic vehicle extant. — Entrance of Queen Isabella into Paris in a litter. — Horse-litters. — Charles VI views his Queen enter Paris sitting on his horse. — Tardiness of art in the fourteenth and fifteenth centuries. — A royal cart. — Close carriage of Frederic III. — Three first carriage-owners in France. — Queen of Navarre enters Amiens in a litter, her husband riding "a goodly genet." — The still mooted question is, Where did coaches originate? — Coach of Henry IV, and his assassination therein. — Men ashamed of coaches. — Picardy cart. — Twin coach-bodies. — Parisian fiacres. — Omnibuses. — Round coaches — Musée de Cluny collection. — Antique phaeton. — Corbillard. — Carriages works of taste, probably caprice. — Caroch, berlué, chariot, diligence, chaise, and brouette. — Boxed-up wives. — Ancient carrosse. — Patents: Simon's, for hanging off bodies; Grobert's, for relieving horses; Leclerq & Crombette's carriage-head; Avril's triolet and Tellier's non-upsetting vehicle. — Monocycle. — Smuggler's trick. — Char-à-banc adopted from the Swiss. — Vis-à-vis, tapissière, dog-cart, brouette, boguet, coupé, demi-caleche, braeck, wicker phaeton, mylord, landau, caleche, and pompé Pages 210-247

CHAPTER IX.

ENGLISH. — Cæsar on landing is opposed by chariots. — Queen Boadicea. — Covina and esseda. — Relics of British scythe-chariots from battle-fields. — Anglo-Saxon chariot. — Hammock wheel-bed. — Anglo-Saxon carts. — Horse-litters. — Chares. — Whirlicote. — Long-wagons. — Chariots. — Carriages at coronations. — Coaches before Queen Elizabeth's time. — Queen Elizabeth's coaches. — Cost of coaches. — The knight and his trumpet. — Coaches satirized. — Stage-coaches introduced. — Fyne Morrison's journal. — Buckingham's coach-and-six. — Taylor's diatribe. — Capt. Bailey's hackney-coaches. — Coaches' overthrow. — Sedans. — Dispute be-

tween Coach and Sedan, with a Beere-cart moderator. — Polyglot inventor. — Coach pictures for ladies' faces. — Post-chaises. — Coach-springs. — More litters. — Glass windows. — Flying coaches. — Lover of his Country *versus* Stage-coaches. — Bad roads. — Coach-makers' arms. — Boyle's soliloquy. — Earl Darnley's chariot. — Bill Jingle's coach for hooped ladies. — Tattler *versus* Coaches and Chaises. — Queen Anne in state to St. Paul's. — Sedan chariot. — Gay's trivia. — Aristocratic carriages. — "Old Chariot's" chariot. — Sedan-cart. — "Upleasantness" between a lord and a lady's chairmen. — Taxing coaches. — Friction annihilated. — Gigs. — Patent coaches. — Tale of an antiquary. — Hogarth's stage-coach. — Lord Mayor's coach and show. — Brouette. — High-fliers. — State-coach. — Flying machines. — Barouche. — Streets of London and coach obstructions. — Embryo omnibus. — Cummings on wheels. — Lord Chancellor of Ireland's coach. — Collinge's axles. — Road protector. — Combined cart and wagon. — Brights and blacks. — Fecing coachmen. — Town and country coaches. — Crane-neck coach. — Landau. — Sociable. — Post-chaise. — Town chariot. — Landauet. — Sulky. — Phaetons, a variety. — Umbrella sociable. — Curricles. — Whiskies. — Builders' lease of carriages. — Traders' naughty tricks. — Coach and post-chariot, 1805. — Jaunting-car. — Barouche, 1805. — Telegraph buggy. — Elliott's inventions. — Detachment of horses from carriages. — Stanhope, Tilbury, and curriole phaeton. — Ackerman's axle. — Britzscha chariot. — First English railway coach. — Charvolant. — Traveling coach, traveling, composite, and post chariot. — Alliterative literature. — Cabriolets, omnibuses, gigs, Dennets, mail-phaetons, and Hansom's cab. — Equirol carriages, Broughams, Clarences, sovereign, and basterna coaches, Harvey's cabriolet, pony, dog-cart, sporting phaeton, wagonette, improved Hansom, family omnibus, coupé, open town barouche, and Elcho sociable landau. — Display in Hyde Park Pages 248-389

CHAPTER X.

NORTHERN EUROPEAN. — Russian vehicles. — Droschke, kibitka, and tarenta described. — Norwegian cariole and travel. — Danish Holstein-vogue. — English coach in Sweden. — German karen and duchess's wedding-present . . . Pages 390-395

CHAPTER XI.

AMERICAN. — Litters of the aborigines. — Colonist wheelwrights. — English carriages in America. — Carmen's contempt for aldermanic ordinances. — New York and Philadelphia post. — John Clapp keeps a hack for hire. — Albanian ordinance regulating "slees and horses." — Removal of posts from the Broadway. — New York and Boston post. — Skelton's and Carpenter's chairs. — Importation of chaises. — James Hallett's cards. — New York City amusements. — John Butler's "waggon" and the Bordentown stage. — Philadelphia and Annapolis stage. — Flying machine. — Improvised hacks. — Mrs. Shoemaker's Recollections. — Curricles. — New York coach-owners. — Burning of Colden's coach. — The Deanes from Dublin. — New York and Boston stage. — Pennsylvanian carriage-owners and carriage-builders. — Travel in Revolutionary times. — Importation forbidden. — Washington's coach. — Henry's coat-of-arms. — McGowan's sledge. — Coach-makers' procession. — New York carriage-makers. — Powell's coach. — Tax on carriages. — Early traveling. — Chaises. — Beginning of carriage-making in Newark, Albany, etc. — Early carriage-makers in New York City. — Country wagons and sleighs. — Parker chal-

lenges Quick. — Volantes. — Parker's "blower." — Connecticut and New Jersey carriage-makers stigmatized as thieves. — Buggies, gigs, phaetons, and chariotees. — The accommodation and public sociable early passenger vehicles in New York. — Barouches, traveling-coach, coachee, dickey-seat phaeton, traveling chariot, double Stanhope, Newark buggy, cabriolet, sulky, and omnibus. — Street-car. — Stage-drivers' bad conduct. — Parker's vehicles. — Butchers' carts, express and business wagons, cabs, Rockaways, Southern coach. — Perch-couplings. — Clip king-bolts. — Jenny Lind, physician's phaeton, square buggy, road sulky. — Stratton's patent mail-axle. — Concord and New Rochelle wagons. — Fenton Rockaway, pony-cart and phaeton, gentleman's road buggy. — Six-seat and cut-under Rockaway. — Clarence, cabriolet, caleche, phaetons, demi-landau, coupé, coupé-Rockaway, Clarence, landau. — Velocipedes. — Trade statistics Pages 396-467

CHAPTER XII.

SUPPLEMENTAL. — Carriages in the American Centennial Exhibition, French, English, American. — Commissioner's report. — M. Guet's remarks on Centennial carriages. — Carriage-builders' national association. — Col. Delancey Kane's drag. Pages 468-482

INDEX Pages 483-488

LIST OF ILLUSTRATIONS.

	PAGE		PAGE
AN OUTSIDE BARBARIAN AMONG THE CELESTIALS	3	EGYPTIAN HUNTING-CHARIOT	59
INITIAL WORD TO PREFACE	3	RAMSES IV CONDUCTING CAPTIVES TO THE TEMPLE OF AMUN	52
AUTHOR'S AUTOGRAPH	4	BATTLE-SCENE FROM THE TEMPLE OF LUXOR	54
EGYPTIAN HUNTING SCENE AND INI- TIAL M	17	CHARIOT OF THE ROT-UN	55
PRIMITIVE SLEDGE	18	EGYPTIAN PLAUSTRUM	56
PRIMITIVE SLEDGE-WAGON	19	CHARIOT FROM THE FLORENTINE MU- SEUM	57
ARISTOTLE'S SYCTALE	19	ANCIENT EGYPTIAN WHEEL	57
AN EGYPTIAN FUNERAL CORTEGE.— THE UNDERTAKER COMES FOR THE BODY	24	STOKE	58
EGYPTIAN SLEDGE-HEARSE	26	WOODEN TIRE	59
ELEGANT SLEDGE-HEARSE	26	COMPLETED CHARIOT-WHEEL	60
AN EGYPTIAN FUNERAL CORTEGE.— THE BODY CARRIED TO THE TOMB	27	FRAGMENT OF SHAFTS	60
WAGON AND BOAT FROM A MUMMY BANDAGE	30	CHARIOT END RAVE	61
SURRENDER OF AN ENEMY TO MENEP- THAH I.—TEMPLE OF KARNAK	31	CHARIOT SIDE RAVE	61
THE VICTORIOUS MENEPHTAH I ON THE HOMEWARD MARCH	32	RIMMING A WHEEL	65
EGYPTIAN WHIPS	33	BENDING THE TIMBER FOR A WAR- CHARIOT	66
WHIP SUSPENDED FROM THE WRIST	34	MAKING THE POLE AND OTHER PARTS OF THE CHARIOT	66
TRIUMPHAL PROCESSION OF MENEP- THAH I.—TEMPLE OF KARNAK	35	BINDING OR TRIMMING A CHARIOT-BODY	68
RAMSES II IN BATTLE.—FROM BEI- TUALLI, IN NEBIA	36	INITIAL LETTER F	69
EGYPTIAN HORSE-BLANKET	37	THE KING OF ASSYRIA CROSSING A RIVER IN PURSUIT OF AN ENEMY. —NIMROUD	71
EGYPTIAN YOKE	38	ASSYRIAN WAR-CHARIOT.—NIMROUD	73
CAPTURED CARTS OF THE TOKKARI	38	ASSYRIAN TREATY OF PEACE.—NIM- ROUD	76
RAMSES III IN HIS CHARIOT.—BASS- RELIEF FROM A TEMPLE AT ABOO- SIMBEL	40	ASSYRIAN LION-HUNTER.—NIMROUD	78
FULLY EQUIPPED WAR-CHARIOT	42	ASSYRIAN WARRIORS IN BATTLE.— KHORSABAD	80
MENEPHTAH III MARCHING AGAINST AN ENEMY.—FROM MEDEËNET HABÔO	44	EUNUCH WITH HORSES	81
EGYPTIAN BAGGAGE-CART	46	THE KING'S CHAIR BORNE BY EUNUCHS. —KHORSABAD	83
MENEPHTAH III PROCEEDING TO THE TEMPLE OF AMUN, MEDEËNET HABÔO	47	CHARIOT CAPTURED BY THE ASSYRIANS. —KHORSABAD	84
		CHARIOT AND CHARIOTEER OF SENNA- CHERIB IN WAITING BEFORE LACHISH. —KOUYUNJIK	86

PAGE	PAGE		
SENNACHERIB IN HIS CHARIOT BEFORE LACHISH. — FROM A BASS-RELIEF IN THE BRITISH MUSEUM	88	CARPENTUM. — CARRYING OFF THE BRIDE	140
SUPPOSED JEWISH CAPTIVES IN A CART	90	CARPENTUM POMPATICUM	142
SUPPOSED SUSIANIAN MULE-TEAM	90	THE PILENTUM	143
ELAMITISH CART IN THE SERVICE OF ASSYRIAN SOLDIERS	91	CISIUM	144, 145
MULE-TEAM AND PARTY AT REST	92	MONACHUS	146
XERXES ORDERS THE SEA CHASTISED (INITIAL A)	93	ROMAN POST BIROTUM	147
CHARIOT FROM THE RUINS OF PERSEPOLIS	94	ARCERA	148
CHARIOT FROM NIEBUHR	95	THE CARRUS	149
ANOTHER CHARIOT FROM THE RUINS OF PERSEPOLIS	96	CARRUS FOR LIQUIDS	151
SUPPOSED PERSIAN CHARIOT FROM THE LYONS COLLECTION	97	CARRUS CLABULARIUS	152
PERSIAN IDOL-CAR	98	HAY-PLAUSTRUM	154
PERSIAN SCYTHIE-CHARIOT	99	ROMAN WINE-CART	154
ANCIENT SCYTHIE-CHARIOT WHEELS. — FROM SCHEFFER	101	PIOSTELLUM	156
GALLICAN COVINUS. — FROM GINZROT	101	THE CURRICULUS	157
SCYTHIE-WAGON BY A MODERN INVENTOR	105	ROMAN CHARIOT	159
ANCIENT SCYTHIE-WAGON. — FROM A RARE PRINT	106	FRONT VIEW OF ROMAN CHARIOT	160
PERSIAN HARMAMAXA	111	ROMAN YOKES	160
ALEXANDER'S FUNERAL CAR	113	CIRCUS CHARIOT	161
INTERIOR VIEW OF ALEXANDER'S FUNERAL CAR	114	ROMAN COLISEUM AND ITS SURROUNDINGS	163
PERSIAN FARMER'S CART	115	RACING QUADRIGA	165
CHARIOT RACE (INITIAL I)	116	AN UPSET QUADRIGA	166
DIPHROS	118	CHARIOT AND TIGERS	168
GRECIAN CHARIOT	119	CHARIOT AND GAZELLES	169
GRECIAN CHARIOT, A TROPHY TO ROME	120	TRIUMPH OF TITUS	172
SIDE VIEW OF GRECIAN CHARIOT	121	PORTION OF A FUNERAL CORTEGE	173
CHARIOT FROM THE PEDIMENT OF THE PARTHEON	123	TWO-WHEELED RHEDA	174
ANCIENT GRECIAN RACING CHARIOT	126	MILITARY OR STATE RHEDA	176
EOS, GODDESS OF THE MORNING	129	HUNGARIAN CARRIAGE. — AFTER GINZROT	177
HORSES GUIDED BY A STAFF	130	THE CARRUCA	178
GRECIAN WAIN, FROM A VASE	131	THE BENNA	179
WAR-CHARIOT OF MARS	132	ROMAN CARRIAGE-PART	180
GRECIAN LADY'S QUADRIGA	133	CURRICULE-EAR AND HORSES (INITIAL C)	183
GRECIAN LADY'S BIGA	135	VICTORY. — POMPEII	184
ETRUSCAN BIGA	136	PARROT BIGA. — POMPEII	185
INITIAL LETTER L	137	SWAN CAR. — POMPEII	186
CARPENTUM, TEMP. CALIGULA	139	MIXED TEAM. — POMPEII	187
CARPENTUM, TEMP. DOMITIAN	139	BIGA AND GRIFFIN. — POMPEII	187
		CAR OF APOLLO. — HERCULANEUM	188
		PIOSTELLUM. — HERCULANEUM	188
		MINERVA'S CHARIOT — HERCULANEUM	189
		MULE-CAR. — POMPEII	190
		CAR OF DIANA. — POMPEII	190
		FEMALE GOATS AND CHARIOT. — POMPEII	191
		MALE GOATS AND CHARIOT. — POMPEII	191

	PAGE		PAGE
SHE-GGATS AND CHARIOT. — POMPEII	192	WICKER PHAETON	245
BIGA. — HERCULANEUM	193	MYLOED	245
RACING-CHARIOT. — HERCULANEUM	193	SINGLE-HORSE LANDAU	246
GROTESQUE CHARIOT-RACE. — POMPEII	194	FRENCH CALECHE	247
THE PLAUSTRUM. — HERCULANEUM	194	POMPÉ	247
WINE-WAGON. — POMPEII	195	SCROLL AND INITIAL V	248
ITALIAN COCHIO	197	BRITISH COVINA, WITH IMPLEMENTS OF WARFARE	250
NEAPOLITAN SEDAN	198	BRITISH ESSEDUM	252
CHINESE CART (INITIAL A)	200	ESSEDUM. — AFTER GINZROT	252
ROYAL CART, BY A CHINESE ARTIST	201	FRAGMENT OF A WHEEL	253
COACHMAN OF THE EMPEROR OF CHINA	202	SAXON CHARIOT	254
INDIAN HECCA	203	HAMMOCK CARRIAGE	255
GUJERAT VILLAGE-CART	204	ANGLO-SAXON CART	256
SCYTHIAN HOUSE ON WHEELS	207	ANGLO-SAXON TRUCK	257
TARTAR CART	203	CART, WITH ANGLO-SAXON HARVEST- SCENE	257
FRENCH DILIGENCE (INITIAL T)	210	HORSE-LITTER OF THE TIME OF ED- WARD III.	258
ANCIENT FLEMISH CARRIAGE	212	LONG-WAGON OF THE FOURTEENTH CENTURY	261
LITTER. — ISABELLA'S ENTRANCE INTO PARIS	213	QUEEN ELIZABETH'S COACH, RIPPON, MAKER	265
FRENCH HORSE-LITTER	214	QUEEN ELIZABETH'S FRENCH COACH	266
FRENCH STATE CHARIOT	216	QUEEN ELIZABETH'S COACHES — FROM HOEFNAGEL'S PRINT	267
COACH OF HENRY IV OF FRANCE	217	ENGLISH COACH OF 1616	271
PICARDY CART	218	TAYLOR'S WORLD ON WHEELS	273
ANCIENT TWIN CARRIAGE-BODIES	219	SEDAN OF 1635	293
PARISIAN FIACRE	220	COACH OF 1635	294
ANCIENT COACH, 1667	221	HORSE-LITTER	299
ANTIQUE PHAETON	223	COACH-MAKERS' ARMS, 1667	306
FRENCH CORBILLARD	224	COACH-AND-SIX OF 1688	307
THE COACH (FR. CAROCH), 1771	226	COACH OF 1696. — FROM A PRINT IN THE BRITISH MUSEUM	308
THE BERLINE	227	CHARIOT OF THE EARL OF DARNLEY	309
CHARIOT	228	STATE COACH OF 1713	311
DILIGENCE	228	SEDAN CHARIOT OF 1713	312
CHAISE	229	CARRIAGE OF THE ARISTOCRACY — TEMP. GEORGES I AND II	314
BROUETTE	230	SEDAN-CART	315
ANCIENT CARROSSE-BODY	232	ENGLISH SEDAN-CHAIR, 1750	317
SIMON'S PATENT	234	ENGLISH PRIVATE COACH, 1750	318
GROBERT'S PATENT CABRIOLET	235	ENGLISH GIG, 1754	319
EXTENSION HEAD FOR CARRIAGES	236	ENGLISH STAGE-COACH, 1755	321
AVRIL'S TRIOLET	236	ENGLISH BROUETTE	325
TELLIER'S PATENT SAFETY CARRIAGE	237	ENGLISH HIGH-FLIER PHAETON	325
MONOCYCLE	237	STATE-COACH OF ENGLAND, 1762	326
CHAR-A-BANC	239	ENGLISH BAROUCHE, 1767	329
VIS-À-VIS	239		
TAPISSÈRE	240		
FRENCH DOG-CART	241		
BOGUET	241		
COUPÉ	242		
DEMI-CALECHE	242		
BRAECK	244		

	PAGE		PAGE
CYLINDRICAL WHEEL	331	ADAMS'S EQUIROTAL OMNIBUS	375
CONED WHEEL	332	ENGLISH BROUGHAM	376
COACH OF THE LORD CHANCELLOR OF IRELAND	332	CLARENCE COACH	376
ROAD PROTECTOR, 1796	333	SOVEREIGN	377
CART AND WAGON COMBINED, 1797	334	BASTERNA COACH	377
TOWN COACH, 1796	336	HARVEY'S CABRIOLET	378
TRAVELING COACH, 1796	337	PONY (VICTORIA) PHAETON	379
CRANE-NECK COACH, 1796	338	SHAMROCK DOG-CART	381
ENGLISH LANDAU, 1796	338	SPORTING PHAETON	381
TOWN CHARIOT	339	ENGLISH WAGONETTE	383
LANDAULET, 1796	340	IMPROVED HANSON CAB	385
CHARIOT, 1796	341	GENTLEMAN'S FAMILY OMNIBUS	386
PHAETON, 1796	342	ENGLISH COUPÉ	387
PONY PHAETON	342	OPEN TOWN BAROUCHE	387
SOCIABLE	344	ELCHO SOCIABLE LANDAU	389
CURRICLE PROPER	345	RUSSIAN DROSCHKE (INITIAL C)	390
NEW-PATTERNS CURRICLE	346	NORWEGIAN CARIOLE	393
GIG CURRICLE	347	GERMAN KAREN	394
CANED WHISKY	348	DUCHESS OF LOTHRINGEN'S COACH	395
GRASSHOPPER-CHAISE WHISKY	348	DRIVE IN CENTRAL PARK (INITIAL W)	396
COACH, 1805	353	SLEIGH OF 1783	413
POST-CHARIOT, 1805	353	THE POWELL COACH	416
IMPROVED CURRICLE	354	THE CHAIR OF 1790	419
JAUNTING-CAR, 1805	354	COUNTRY PLEASURE-WAGON	422
BAROUCHE, 1805	357	EARLY AMERICAN SLEIGH	423
TELEGRAPH, 1805	358	ALBANY SLEIGH	423
O. ELLIOTT'S CHARIOT, 1805	359	AMERICAN STAGE-COACH, 1830	424
STANHOPE GIG	360	SPANISH VOLANTE	427
TILBURY	361	AMERICAN BUGGY, 1826	429
TILBURY SPRING. — REAR VIEW	361	FAN-TAILED GIG	450
CURRICLE PHAETON	362	SLAT-SIDE PHAETON	431
ACKERMAN'S MOVABLE AXLE	362	GIG CHARIOTEE	431
POST-CHAISE, 1825	363	AMERICAN CHARIOTEE	431
BRITZSCHA CHARIOT	363	THE ACCOMMODATION	432
FIRST ENGLISH RAILWAY COACH	364	PUBLIC SOCIABLE	432
VINEY & POCOCK'S CHARVOLANT	365	AMERICAN BAROUCHE	433
TRAVELING CHARIOT	366	C-SPRING BAROUCHE	433
CONTINENTAL TRAVELING COACH	366	AMERICAN TRAVELING COACH	434
COMPOSITE CHARIOT	367	C-SPRING COACHEE	434
POST-CHARIOT, 1829	367	DICKEY-SEAT PHAETON	435
PRIVATE CABRIOLET	369	TRAVELING CHARIOT	475
FIRST ENGLISH OMNIBUS, 1829	370	DOUBLE STANHOPE	436
ENGLISH GIG, 1830	371	CARTER'S NEWARK BEGGY	436
CAB DENNET	371	AMERICAN CABRIOLET	437
CABRIOLET	372	SULKY	437
MAIL-PHAETON	372	BROWER'S OMNIBUS	438
HANSON'S CAB	373	AMERICAN STREET-CAR	440
ADAMS'S EQUIROTAL PHAETON	375	AMERICAN CLARENCE	440
		PARKER'S COACHEE	441

	PAGE		PAGE
BUTCHER'S AND GROCER'S CART	442	AMERICAN CLARENCE	458
IMPROVED BUTCHER'S CART	442	CABRIOLET	458
AMERICAN EXPRESS WAGON	442	AMERICAN CALECHE	459
AMERICAN CAB	443	CUT-UNDER ROCKAWAY	460
PHAETON	443	MODERN OMNIBUS	460
IMPROVED BUSINESS WAGON	444	GIG PHAETON	461
ROCKAWAY	445	CANOE PHAETON	461
GERMANTOWN	445	DEMI-LANDAU	462
SOUTHERN COACH	446	CIRCULAR-FRONT COUPÉ	462
CUT-UNDER BUGGY	447	IMPROVED SCROLL-SPRING	463
EVERETT'S PERCH-COUPLING	447	SIX-SEAT COUPÉ-ROCKAWAY	463
HAUSSKNECHT'S PERCH-COUPLING	448	THREE-QUARTER CLARENCE	464
ANOTHER HAUSSKNECHT COUPLING	449	FRAME-WORK OF HIND CARRIAGE- PART	464
REYNOLDS'S KING-BOLT	450	BONNER BUGGY	464
PHELPS'S KING-BOLT	451	TOP BUGGY	465
JENNY LIND	452	AMERICAN LANDAU	465
PHYSICIAN'S PHAETON	452	AMERICAN VELOCIPÈDE	466
SQUARE BUGGY	453	GOMPERT'S DRASINA	466
ROAD SULKY	453	SCROLL INITIAL LETTER O	468
STRATTON'S PATENT MAIL-AXLE	454	MILLION, QUIET & Co.'s EIGHT-SPRING LANDAU	469
MAIL-AXLE COLLAR-PLATE	454	PETERS & Sons' LADIES' PHAETON	472
CONCORD WAGON	455	HOOPER & Co.'s DRAG	472
NEW ROCHELLE WAGON	455	BREWSTER & Co.'s DOUBLE-SUSPEN- SION VICTORIA	476
FENTON ROCKAWAY	456	MCLEAR & KENDALL'S VIS-À-VIS	477
PONY-CART	456	JAMES CUNNINGHAM & Son's HEARSE	478
PONY-PHAETON	456		
GENTLEMAN'S ROAD BUGGY	457		
SIX-SEAT ROCKAWAY	457		



THE WORLD ON WHEELS.

CHAPTER I.

ANCIENT EGYPTIAN SLEDGE-BEARERS, CHARIOTS, AND CUSTOMS.

. . . "Nor Thebes so much renowned,
Whose courts with unexhausted wealth abound;
Where through a hundred gates, with marble arch,
To battle twenty thousand chariots march."¹

HOMER'S *Iliad*, B. IX, v. 384.

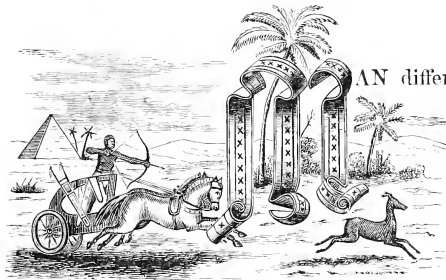

MAN differs from other animals, for while the lower orders roam about certain districts in search of food which, when obtained, satisfies their longings, he, with a loftier ambition, is unceasingly occupied in the pursuit of some new discovery whereby he may promote his own interests and increase the comforts of his fellow-man.

¹ Writers in later times tell us that the hundred gates spoken of by Homer in his inimitable poem were only imaginary, the creations of a poetical fancy. Herodotus is silent on this subject; but Diodorus Siculus (Lib. I) says, "Although there are some who say that it had not an hundred gates, yet that there were many large porches to the temples, whence the city was called *Ἑκατομπίλος* (*Hecatompilos*), a hundred gates; yet it was certain that they had in it twenty thousand chariots of war, for there were a hundred stables all along the river [Nile] from Memphis to Thebes." Apuleius ("Golden Ass," Lib. IV, Epode 4) mentions the "seven-gated Thebes," and Ammianus Marcellinus ("Roman Hist.," Lib. XVII, ch. 4, sect. 2) confirms Homer, assuring us that Thebes was celebrated for its "entrances by a hundred gates." Heyne, in reference to this subject, observes, "*Numerus centenarius ponitur pro magno: et portis semel memoratis, multitudo hominum declaratur per numerum eantium.*"

With a special object in view, then, since walking, the primitive mode of locomotion, had been found tedious and painful, after experiment, he managed to bring into subjection assistants from "the beasts of the field," such as horses, asses, oxen, camels, etc., for both burthen and draught, thus utilizing such agencies as were at command.

One of the earlier modes of travel undoubtedly was horseback riding; but in process of time the necessities, as well as the imaginary wants of man's nature, greatly multiplied. He very soon discovered that horseback conveyance of person and merchandise was attended with serious drawback. Stimulated to activity, his inventive facul-

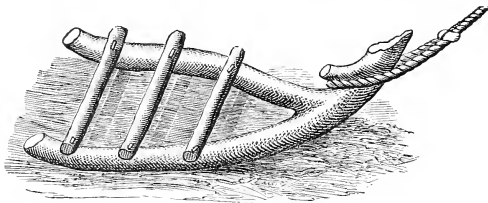

PRIMITIVE SLEDGE.

ties provided a remedy in the form of a sledge,¹ which, with various modifications, is still employed in different portions of the globe. This primitive invention, at

first rude and imperfect, was certainly one step in the art of carriage-building, since wonderfully improved upon,—the germ of art bequeathed to man by an all-wise Creator having in the course of time produced an abundant harvest.

As art progressed, it required but little reflection to foresee that, by placing this sledge upon rollers, much of the difficulty originally encountered would thereby be overcome, and an increased weight moved by the same force with more ease. This important discovery, effected by exchanging the rubbing motion of the sledge for the rolling motion of a cylinder, whether accidental or the studied invention of some early mechanic, is of very little consequence now.

¹ In Europe, sledge is the name applied to a low kind of cart, but in America the word has been abbreviated to sled or changed to sleigh, which in either case involves the idea that a *sliding* vehicle is meant. In the rural districts, the farmer employs a machine we call a stone-sledge. This is commonly made from a plank, the flat under surface of which is forced along the surface of the ground by ox-power. Its chief advantages are, it is the more easily loaded with the heavier stone. In this, as in many other cases, *brutal* man has transferred his burthen to the *dumb* animal, which has not the power to complain. This is a fair illustration of the power of knowledge over stupidity and ignorance ever since.

On the walls of a temple at Luxor, in Thebes, is seen an early representation of the sledge, connected with the germs of an improvement. A reduced copy is here given. It exhibits a sledge elevated

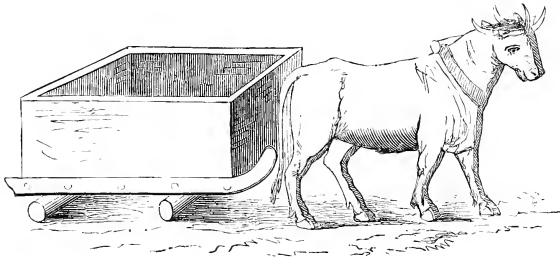

PRIMITIVE SLEDGE-WAGON.

upon two logs, constituting what may appropriately be called an inceptive sledge-wagon. These logs were undoubtedly suggestive of the common axle since in use. The original mechanic needed only to secure these logs to the superincumbent structure, shape the ends into journals, fitted to a hub, when everything, for a practical use, would be complete. Timber for the axle-tree was already at hand; so was the material for the wheels. These *wheels* were probably at first nothing more than what are now designated "pauc-wheels,"¹ cut transversely from the tree, having a hole made in the center for an axle-tree, such as are still applied to the carts of less civilized people in modern times.

Although no mechanic of modern times agrees with him, yet it has been claimed by Aristotle that the *syctale* has many advantages over carts with axles and wheels, arguing that an axis impedes the progress of wheel-vehicles by pressure on the hub. As an example of early theoretical science, this idea has some interest taken in connection with our subject.

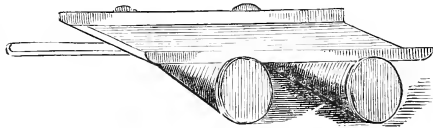

ARISTOTLE'S SYCTALE.

¹ Pauc-wheels were originally so called because in a side view they resembled the head of a drum. Specimens will be seen on some of our Roman carts.

No student of the Bible but believes that carriage-building had its rise in Egypt, notwithstanding that profane authors have since claimed that Ethiopia furnished the land of the Pharaohs with the rudiments of her architecture in common with Nubia and India. In those old countries are still found numerous excavations in the rock, of immense extent, furnished with colossal figures, vast masses of building raised from the earth, with a profusion of carving and statuary, besides shrines worked in a single stone,—the whole of these achievements on a scale of such vast extent and magnificence, the apparent results of such wondrous physical or mechanical power, that we are disposed to think of the giants who are said to have lived previous to the flood, rather than of men of ordinary stature, as the authors of all these magnificent works.

“No people,” says Champollion, “either ancient or modern, conceived the art of architecture on so sublime a scale as the ancient Egyptians. Their conceptions were those of men an hundred feet high; and the imagination, which in Europe rises far above our porticoes, sinks abashed at the foot of the one hundred and forty columns of the hypostyle hall at Karnak.”¹

¹ An *hypostyle hall* is one supported by and resting upon pillars, while the *peristyle* is one having pillars running around it. The group of ruins known by the name of Karnak lay one and a half miles northeast of those at Luxor, and about one half mile from the eastern bank of the Nile. The chief portion of the ruins stand on artificial elevations, which are inclosed within walls about three miles in circuit. Among these ruins stands the great temple from which many of our illustrations are taken, the temple itself surpassing in grandeur any other in Thebes. This structure has no less than twelve entrances and numerous gateways adorned with finished hieroglyphics. The great hall in this edifice is three hundred and twenty-nine feet long and one hundred and seventy feet wide, the columns supporting the ceilings standing in nine parallel rows, sixty-six feet high and nine feet in diameter. This temple is very ancient, the name of Osirtessen I, who ruled when Joseph visited Egypt (*circa* B. C. 1740), being recorded on its walls. The seat of government was changed from Lower Egypt to Memphis, but succeeding monarchs continued to make additions to the records on the walls of the temple many years afterwards. The great hypostyle hall is supposed to have been built by Rameses I, some fifteen centuries before Christ. The sculptures on the exterior of the walls are cut in the same kind of bass-relief as those at Luxor.

For seventeen centuries prior to the conquest of Egypt by the Persians (B. C. 525), it was governed chiefly by independent native sovereigns, who are supposed to have ruled contemporaneously over different portions of the country. Few, indeed, are the records we possess of the many interesting events that must have occurred during her existence. Such as have come down to us are as follows: The arrival of Joseph

Although the Assyrian empire was founded fifteen years earlier than the Egyptian, yet it is to the latter we must accord pre-eminence in chariot-building as well as in many other arts. According to history, the most prosperous age was that of the eighteenth and nineteenth dynasties of Theban monarchs, to which age Manetho assigns the most prosperous period in Egyptian art. *Rameses II* (*Amunui Rameses*, as his name is read in hieroglyphics, and *Rameses Miamum*, according to Manetho), now called *Rameses the Great*, was the most renowned monarch that ever ruled over Egypt. He is supposed to be identical with the far-famed *Sesostris* of the Greek writers, his name being found more frequently on the monuments of Thebes, and indeed throughout Egypt, than that of any other king, there being few remains of any city where it is not seen. He is supposed to have flourished B. C. 1500.

Thus much we have thought it necessary to say by way of introduction to the important as well as interesting history of vehicular art, connected with the designs we reproduce on a reduced scale from the catacombs¹ and other monuments of antiquity.

in the reign of *Osirtessen I* (B. C. 1740), mentioned in *Gen.*, ch. xxxviii; the journey of *Abraham* thither, "when a famine prevailed over all the land," as recorded in *Gen.*, ch. xi; the birth of *Moses* (B. C. 1571) during the reign of *Rameses*, supposed to have been the new king "who knew not *Joseph*" (*Exod.*, ch. i, v. 8); the flight of *Moses* (B. C. 1531), related in the second chapter of *Exodus*; the exodus of the Israelites from Egypt (*Exod.*, ch. xii; B. C. 1491); the marriage of *Solomon* with *Pharaoh's* daughter (*1 Kings*, ch. iii, v. 1; B. C. 1014); the invasion of *Judæa* by *Shishak* (*2 Chron.*, ch. xii, v. 2; B. C. 971) or *Sheshonk*, as it stands in hieroglyphics on the monuments still extant (this king came up to Jerusalem with twelve hundred chariots and threescore thousand horsemen, despoiling the temple of its sacred treasures); the defeat and slaying of *Josiah*, king of *Judah*, in the valley of *Megiddo*, by *Pharaoh Necho* — *Necho* on the monuments (*2 Kings*, ch. xxiii, vs. 29, 30; B. C. 623); the capture of *Sidon* by *Pharaoh Nophra* (*Ezek.*, ch. xxx, v. 24; *Herodotus II*, 161-169; B. C. 595); and the subsequent defeat of this monarch in an expedition against *Nebuchadnezzar*, king of *Babylon* (B. C. 570).

¹The catacombs are thus described by a classical author: "Sunt et syringes subterraneæ quidam et flexuosi secessus, quos (ut fertur) periti vitum vetustorum adventare diluvium præseii metuentesque ne ceremoniarum oblitteraretur memoria, penitus operosis digestos fodinis, per loca diversa struxerunt; et excisis parietibus, voluerunt ferarumque genera multa sculpsērunt, et animalium species innumeras multas, quas hieroglyphicas literas appellarunt, Latinis ignorabiles." — *Amianus Marcellinus*, B. XXII. (*Translation*. — There are certain underground excavations made in different places, with winding retreats, wherein it is said men skillful in ancient mysteries divine the coming of a flood, lest the memory of all their sacred ceremonies might be lost.

Among the ancients, particularly among the Egyptians, the death of a relative or friend was an event of the greatest and most solemn importance. All the kindred and friends of the deceased quitted their usual employments, let their hair grow both on the head and face, although until then accustomed to shave, put on mourning from forty to seventy days, according to the rank of the deceased, abstaining from wine, baths, and luxuries of every kind.¹

The immortality of the soul was an important tenet in Egyptian theology.² By them sepulchers of the most substantial description were constructed for holding the body after the spirit had fled, with what success time has shown. Many of these were vast underground repositories in which thousands in a mummified state have slept for centuries, awaiting the return of the "living principle" to reanimate it. In these subterranean palaces, on the walls, in bass-relief, have been preserved, in their original state, the records of those ancient times. These, which are the fruit of modern research, will assist us in giving with correctness many incidents not hitherto presented to the world in connection with carriages.

On the walls, deeply chiseled, they have cut several kinds of beasts and birds, with countless other figures of animals, which are called hieroglyphical letters, of which the Latins are ignorant)

¹ Herodotus, B. II, v. 36.

² Infidelity found no advocates among the ancient Egyptians. They considered the present life as a pilgrimage, and their abode here as an "inn" upon the road. After death they expected to be received into the company of a Being who represented the Divine goodness, should judgment pronounce them worthy. All ranks of the people were considered as equally noble beyond the tomb, neither did kings or heroes rank any higher than the humblest in another life. The respect paid to their memory depended entirely on their good conduct while here, the Egyptian laws wholly prohibiting indiscriminate praise. Such honor as a respectable burial could only be obtained after the judges, selected for the purpose, had adjudged the subject worthy from an impartial examination of his life. If no crime attached to his conduct, the body was interred in an honorable manner; if stained, it was deprived of burial. So strictly was this rule enforced that many of the kings, although borne with in life, were forbidden sepulture thereafter. A favorable judgment obtained, the mortuary ceremonies proceeded. In all panegyrics on such occasions, no mention was made of birth, every Egyptian being deemed equally noble in this respect. No praise was thought just or true except such as related to the personal merit of the dead. "He was applauded," says Rollin, "for having received an excellent education in his younger years, and in his advanced age for having cultivated piety toward the gods, justice towards men, gentleness, modesty, moderation, and all other virtues which constitute the good man." Such virtues gratified the friends of the departed, since such a life would admit him to Pluto's kingdom and the society of the good in another world.

We have not room, even had we the disposition, to enter fully into the particulars history gives us concerning the mode of embalming as practiced among the Egyptians. Consequently we must refer the reader for details to the interesting pages of Herodotus and Diodorus Siculus. Assuming that the sledge was early used for the conveyance of the dead body at a period when, as yet, no other had been invented, and under circumstances where much honor was conferred, and that it was continued ever after on funeral occasions, even after chariots came into use, because custom had rendered it sacred, our theory that such were first constructed is at least made very plausible in the absence of other direct testimony. We are distinctly given to understand by contemporary historians that the Egyptians scrupulously observed their ancient customs, but acquired no new ones.¹ This, undoubtedly, accounts for the presence of sledge-hearses in all representations showing the removal of the dead throughout every age of Egyptian sculpture.

It need not be inferred from what we have written that all bodies were hidden away in the tomb. On the contrary, many were consumed on the funeral pile, some were buried in the earth, while others again, after they had come from the embalmer's shop, were kept in the house for years, until finally they were deposited in the catacombs. The mourning for a good king lasted the space of seventy days, during which the people sang hymns commemorating his virtues, rending their garments, and covering their heads with mud and dust, some three hundred persons of both sexes coming together twice each day to publicly sing a funeral dirge, the entire nation abstaining from meat and other dainties during the whole time. On the last day of mourning, or in some instances many months afterward, the time for sepulture arrived. Supposing that an embalmed king is to be laid away, perhaps in a tomb on which a lifetime of preparation has been bestowed, the body is now brought out from the closet, where it has been carefully stored since the funeral ceremonies were performed, and given to the undertaker, who comes with a sledge-hearse, as shown in the engraving on the next page. The several figures are thus arranged: in the center appear the sacred cows, decked with elegant

¹ Herodotus, B. II, ch. 79.

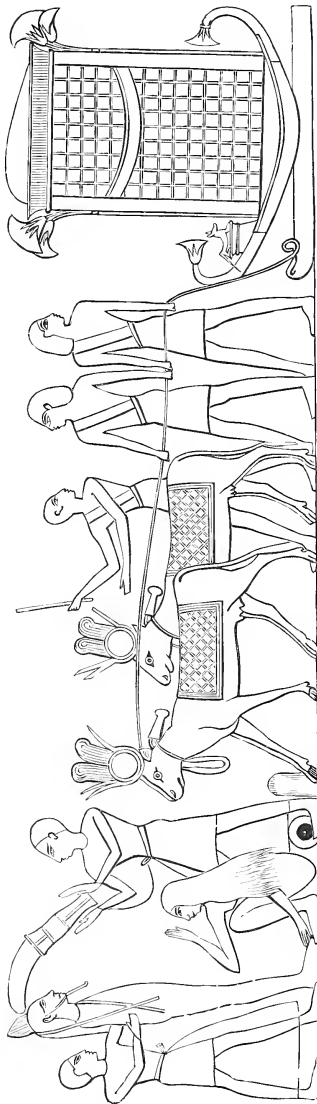

AN EGYPTIAN FUNERAL CORTEGE. THE UNDERTAKER COMES FOR THE BODY.

blankets and ornamental head and neck gear,¹ which last (of a peculiar pattern) is found attached to the heads of all female animals, in Egyptian bass-reliefs, drag-ropes in this case being fastened to the horns, evidently "more for ornament than use," two attendants furnishing the motive-power, while a third acts as conductor. In the foreground are four more representatives of the *genus homo*. First, we notice the priest, as indicated by the peculiarity of his dress. He appears in the act of anointing the dead body with sacred oil, or some other liquid, from a vessel of peculiar shape. Just in front of the priest, squatting near the earth, we find a *mercenary* mourner, her hair disheveled, her breasts exposed, and her hands fixed in the position most expressive of grief, no doubt crying as sincerely as in *hired mourning* it has ever been done. Around the third figure centers the greatest interest, since it represents the dead dressed in cerements for the tomb, to which the body is now about to be carried. The fourth, supporting the corpse in a leaning position, represents an attendant, who, in all probability, officiates both as priest and un-

¹ The ancient Egyptians revered the cow more than any other animal. — *Herodotus*, B. II, ch. 41.

dertaker on this occasion.¹ This picture represents a funeral cortege before the house of mourning, from whence a corpse previously embalmed is about to be removed to a tomb beyond the river, — that is, to the western side of the Nile, — a sort of boat (Egyptian, *baris*) in which is placed a hearse, resting on the sledge. On a sort of dais in front of the boat is placed the figure of a fox (probably indicative of wisdom), both the hearse and boat being appropriately ornamented with papyrus flowers. The rituals for the dead being chiefly written on paper made from this plant, we conclude, lacking other testimony, there was something peculiarly sacred about it, and therefore it was used on funeral occasions.

In another bass-relief the body is represented as actually on its way to the tomb, stretched upon a bier, placed on the sledge-hearse, the order of procession being thus: first, two sacred oxen travel in advance of the hearse, on which the boat is placed. A rope connects the front of the sledge with the horns of the oxen, one animal following the other, after the manner of the cows on page 24. These oxen are attended by two conductors, the foremost holding up a whip as if about to strike with it, while his companion, with distended arms, at the top of his voice, appears to be hastening their steps. A third follows after, holding some sacred utensil; then march two more men grasping the cord at the middle; the sixth figure being the indispensable female in the *rôle* of chief mourner, as previously observed. These all precede the sledge-hearse. Next, behind the hearse, comes another mourner; then two scribes, having scrolls in their hands,

¹ "In sacred subjects the law was inflexible, and religion, which has done frequently so much for the development and direction of taste in sculpture, had the effect of fettering the genius of Egyptian artists. No improvements resulting from experience and observation were admitted in the mode of drawing the human figure: to copy nature was not allowed; it was therefore useless to study it; and no attempt was made to give the proper action to the limbs. Certain rules, certain models, had been established by the priesthood, and the faulty conceptions of ignorant times were copied and perpetuated by every successive artist; for, as Plato and Synesius say, the Egyptian sculptors were not allowed to attempt anything contrary to the regulations laid down regarding the figures of the gods; they were forbidden to introduce any change, or to invent new subjects and habits; and thus the art, and the rules which bound it, always remained the same. — WILKINSON'S *Ancient Egyptians*, Vol. II, p. 264. This condition of affairs is said to have continued without much improvement for about three thousand years, or down to the eighteenth dynasty, according to Manetho, — two thousand and eighty-two years previous to the advent of the Saviour.

followed by two others bearing staves. The scribes are supposed to carry the papyrus rolls, in which are written the good deeds of the departed, without which no Egyptian, as we have seen, could be honorably interred.

In one instance,—as in the annexed copy, taken from a tomb in Thebes,—an attendant is shown, pouring some kind of a liquid from a jar upon the ground, over which the sledge is drawn, to facilitate its progress. Examples of this nature are frequently seen in Egyptian

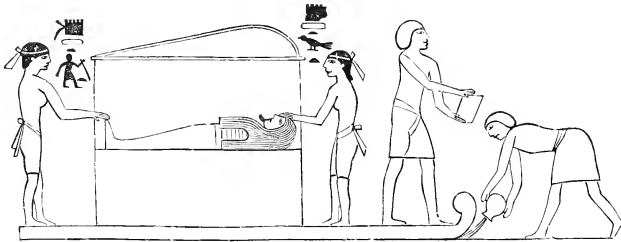

EGYPTIAN SLEDGE-HEARSE.

bass-reliefs, depicting the removal of heavy loads. On this sledge-hearse the mummy-case, enclosing the corpse, is distinctly observed. With characteristic tenderness, two females steady the mummy as it moves along over the rough surface of the ground; the priest, meanwhile, mounted in front, scroll in hand, recites a panegyric, or perhaps delivers a funeral oration in honor of the dead. The priest,

as is proved from the bass-reliefs representing funerals, was an important personage on all such occasions. That they enjoyed much honor and many privileges is admitted by all historians.

A very showy affair is found in the next illustration, rivaling the mourning equipages of modern times. Among other figures appear emblems of stability

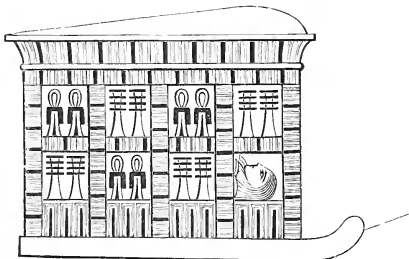

ELEGANT SLEDGE-HEARSE.

and security¹ on the side panels. In this instance the undertaker has removed a portion of the paneling so as to expose the head of the mummy-case. It would seem from this, that the modern practice of showing a coffin through a glass side is of great antiquity. Indeed, we seldom find anything *new* that has not an antiquarian origin, thus verifying the words of the wise man, "There is no new thing under the sun."²

In another picture we find a boat-hearse, represented as drawn by a rope attached to the horns of four sacred oxen, driven abreast, the machine being accompanied by six persons: first, a priest, with his head shorn and bound with a ribbon, carrying his hands aloft, followed by a driver with a whip, both marching abreast of the animals; behind these, a third person, bearing the record of the defunct man's life in his right, and a skin-bottle or pail in the left hand; next, another priest in a leopard-skin cassock, who offers incense from a censer held in the right hand, at the same time pouring out a libation to the gods, or in honor of the deceased, from a cup in the other. The mummy-case is seen through an opening in the side of the hearse near the bottom, behind which the indispensable mourner, with hair disordered and hand resting on her head, but in this case assisted by a male companion with short hair, the left arm, with a spread hand, hanging down by his side.³

In a third example — illustrative of ancient funeral customs among the Egyptians, likewise copied from the walls of a catacomb —

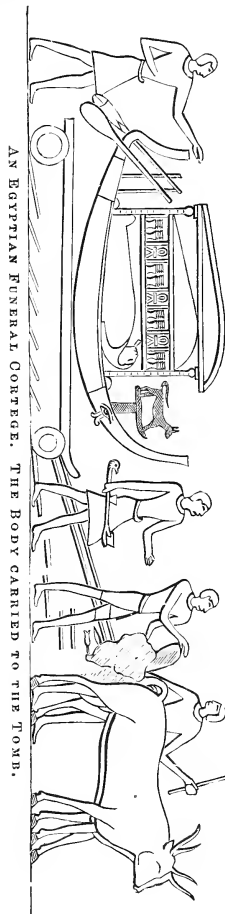

¹ That is, figures representing Osiris as the god of stability and security.

² Eccles., ch. i, v. 9.

³ Rossellini's *Monumenti dell'e Egitto e delle Nubia*, Pl. CXXXVIII.

the cortege is represented as being on its way to the river, across which it must pass in order to reach its destination. For this purpose the boat has been put on the funeral sledge, the sledge itself being now mounted upon wheels, thus seeming to confirm our theory that the sledge was the original of all the wheeled carriages known. Some idea of the progress of art may be obtained by comparing the last engraving with that on page 24. These hearses, employed for like purposes, are constructed somewhat differently. In the last figure we see the sacred oxen, the driver, and another man, whose mark of office has been destroyed by time; next, the priest bearing a censer; and then another man in the rear, who appears to have the direction of the whole movement. The oars at the stern of the boat indicate that the crossing of some stream is intended. At the prow is the image of a fox, and below an eye, representing the all-wise and all-seeing attributes of Deity. In the language of antiquity, the helmsman or pilot was called Charon, from which circumstance is supposed to have originated the fable of Charon and his boat among the Grecians. According to this fable, Charon, the son of Erebus and Nox, who serves as the ferry-man of Hades, wafts the souls of the dead in a boat over the Stygian Lake, to receive judgment from Æcus, Rhadamanthus, and Minos, for which service Charon received an obolus from the passenger, friends placing the money in the dead man's mouth for that purpose.¹

Wilkinson thus describes an ancient Egyptian funeral procession: "First came several servants carrying tables laden with fruit, cakes, flowers, vases of ointment, wine and other liquids, with three young

¹ Virgil puts the following words into the mouth of the sibyl, in the infernal regions:—

"Portitor has horrendus aquas et flumina servat
 Terribili squalore Charon; cui plurima mento
 Cavities inculta jacet; stant lumina flamma;
 Sordidus ex humeris nodo dependet amictus.
 Ipse ratem conto subigit, velisque ministrat,
 Et ferruginea subvectat corpora cymba;
 Jam senior."

Æn., B. VI, 293-304.

(*Translation.*—The ferry-man Charon, offensive with horrible filth, whose abundant gray hair lies neglected on his chin, protects these waters and these rivers; his eyes of flame stand out; a dirty dress in a knot hangs from his shoulders. A raft supplied with sails he guides with a pole, and in an iron-colored boat he carries over the now withered bodies.)

geese and a calf for sacrifice, chairs and wooden tablets, napkins, and other things; then others bringing the small closets in which the mummy of the deceased and his ancestors had been kept while receiving the funeral liturgies previous to burial, and which sometimes contained the images of the gods. These also carried daggers, bows, sandals, and fans, each man having a kerchief or napkin on his shoulders. Next came a table of offerings, fanteuils, couches, boxes, and a chariot; and then the charioteer with a pair of horses yoked in another car, which he drove, as he followed on foot, in token of respect to his late master. After these were men carrying gold vases on a table, with other offerings, boxes, and a large car upon a sledge borne on poles by four, superintended by two men of the priestly order; then others bearing small images of his ancestors, arms, fans, the scepters, signets, collars, necklaces, and other things appertaining to the king, in whose service he had held an important office. To these succeeded the bearers of a sacred boat; and that mysterious eye of Osiris, as god of stability, so common on funeral monuments, — the same which was placed over the incision in the side of the body when embalmed, as well as on the prow and rudder of the funeral boat, — was the emblem of Egypt, and was frequently used as a sort of amulet, and deposited in the tombs. Others carried the well-known small images of blue pottery, representing the deceased under the form of Osiris, and the bird emblematic of the soul. Following these were seven or more men leaning upon staves or wooden yokes, cases filled with flowers, and bottles for libations; and then seven or eight women, having their heads bound with fillets, beating their breasts, throwing dust upon their heads, and uttering doleful lamentations for the deceased, intermixed with praises of his virtue.”¹

A singular instance of the wagon and funeral-boat in combination has been found on the bandage of a mummy, now preserved in the collection of S. d’Athanasii. It is supposed by some modern authors

¹ The oldest relic of humanity known with certainty is that of Pharaoh Mykerinus (Menkeres), deposited in the British Museum in 1867. This king succeeded the heir of the builder of the Great Pyramid, and is supposed to have lived ten centuries before Christ, and before Solomon was born; about eleven centuries or so after Mizraim, the grandson of Noah, and the first of the Pharaohs had been gathered with their fathers. It is judged that the tide-marks of the Deluge had scarcely become obliterated when this man of the early world “lived, moved, and had his being.” The mummy is well preserved, in its original burial-robos.

that Herodotus, in speaking of the religious ceremonies in honor of Mars, as performed in the city of Pamphemis, refers to this vehicle. Among other things, he tells us that the priests placed an image in a wooden temple, gilded all over, which they carried to a sacred dwelling; "then the few who were left about the image draw a four-wheeled carriage containing the temple and the image."¹ Notwithstanding

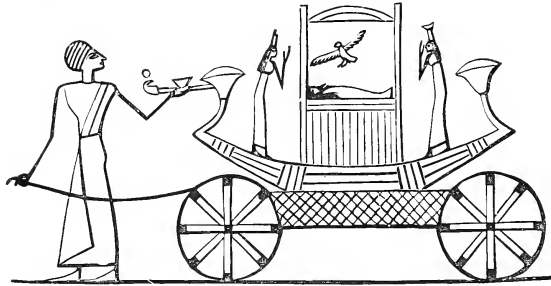

WAGON AND BOAT, FROM A MUMMY BANDAGE.

all historians have said on this subject, we judge that this vehicle is the same sledge-hearse we have seen before, *with later improvements*. The mummy-case

and other accessories seem to favor this conclusion, and the eight-spoked wheel is good evidence that it was invented near the close of Egyptian prosperity, or after superstition had been in some measure overcome by intercourse with the Israelites in the days of Solomon, who had in his harem an Egyptian princess, daughter of one of the Pharaohs.

Having, as we think, conclusively shown that the earlier vehicles were sledges, next, that they were mounted upon wheels, we now proceed, as nearly as possible in chronological order, and give, in connection with Egyptian ceremonies, copies from bass-reliefs, on a reduced scale, showing the progress in chariot-building among that ancient people. We discover nothing but bigas—two-horse vehicles—on any monument; and when battle-scenes are delineated, only two persons in a chariot, the driver and the combatant, unless a king be represented, when he appears unattended by a charioteer. It has been suggested that the ancient artist may have omitted the driver in order not to interfere with the principal figure;² but the faithfulness of the bass-reliefs receives confirmation from the Greek and Roman

¹ Herodotus, B. II, v. 63.

² Wilkinson's *Ancient Egyptians*, Vol. I, p. 371.

authorities, who describe their heroes as always engaged in single combat.

Our first chariot is copied from a bass-relief on the walls of a temple at Karnak, commemorative of the victories of Menepthah I in various portions of Asia and Africa, about sixteen hundred centuries previous to the advent of Christ. Ours is a reduced copy from the great work of Rossellini, published by authority of the Tuscan government.¹ The series begins with the representation of an attack upon a castle situated on a hill, in which many soldiers are slain and the Egyptians are conquerors. The upper portion of the original slab time has destroyed, but sufficient remains to show that

¹ Monumenti dell' Egitto e della Nubia disegnati della spedizione scientifico-letteraria Toscano in Egitto distribuiti in ordine di materie interpretati ed illustrati del dottore Ippolito Rossellini direttore della spedizione Professore di lettere storia e antichità orientali nell'i e. r. Università di Pisa, membro ordinario dell' Istituto d'Archeologia è corrispondente di varie Accademie d' Europa: Pisa presso Nicolo Capurio, e c MDCCCXXXII. This is numbered Pl XLVI. "Commincia la serie delle battaglie e conquiste di Menepthah I, nell' Africa rappresentate in grandi bassorilievo a Karnac." A. M. circa 2401, B. C. 1604. Menepthah I reigned twenty-four years.

SURRENDER OF AN ENEMY TO MENEPTAH I.—TEMPLE OF KARNAK.

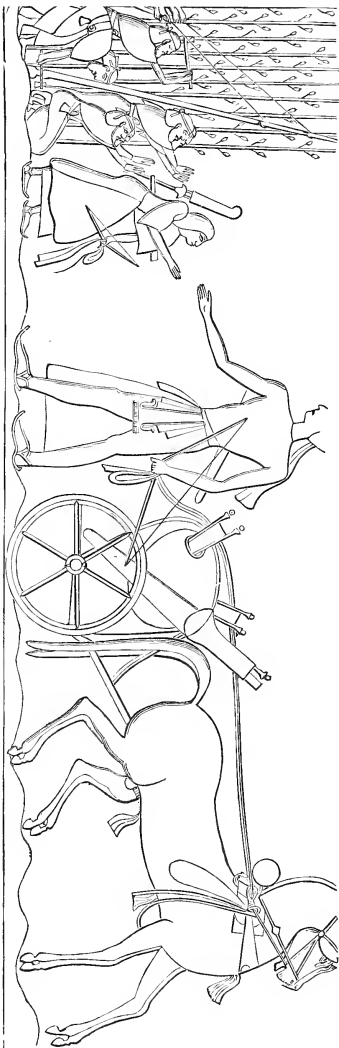

the king, represented in colossal proportions, having dismounted from his chariot, is now accepting the "unconditional surrender" of his foes, who, in a supplicating mood, may be seen emerging from the forest. To prove the sincerity of the enemy, two men are represented in the act

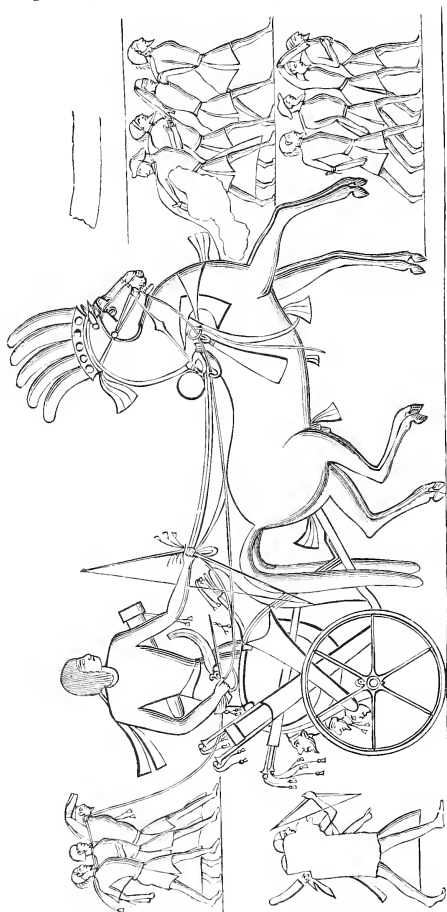

THE VICTORIOUS MENEPTAH I ON THE HOMEWARD MARCH.

of felling a tree, while two others (omitted in the engraving) lower it by ropes fastened high up among the branches. The two chief actors, having sandals to their feet, show that they are principals in the negotiation, the soldiers being barefooted. The conqueror and the conquered both extend the right hand, while holding each his bow in the left, the king all the while holding his horses by the reins. Behind the fallen chieftain stand and kneel four others with outstretched hands, pleading for mercy, all of which is very significant. The body of the chariot is shown in outline, with the top corners rounded off, proving the good taste of the artisan even in those early times.

Another bass-relief

represents the triumphal homeward march of the king, further showing the manners and customs of this interesting people. Although the artist intended to give us a picture of the party of which the preceding forms a section, yet when we compare the two, we find that the furniture of both horses and chariots differs in many essential points. Here the king—as usual, of huge proportions—is represented as grasping a falchion and reins in the right hand, at the same time holding in the left other reins, his bow, and a collection of lotus flowers, while at his shoulder dangles an empty quiver, showing that the warrior's labor is finished. At the rear of the chariot hang the heads of slain enemies. Three captives in leading-strings and the king's body-guard follow behind, while several other captives are marching before the chariot, having their arms bound. A profusion of flowers, expressive of joy, ornament the bow-cases. The ostrich-plume head-dresses, effaced by time in the previous picture, are here seen "in full feather." Leaving our hero on his triumphal march homeward, let us now examine some of the inside furniture and other matters in connection with Egyptian chariots.

There is no positive evidence of the existence of seats in Egyptian chariots, and in every instance the passengers are represented in a standing position. If these ever sat, they probably did so resting on the top-rail. We often find representations on the bass-reliefs where men are tumbling out of the back end when slain. In some chariots the bottoms or floors are made of ropes interlaced, thereby imparting to it a certain degree of elasticity. Wilkinson says that

"in driving, the Egyptians used a whip, like the heroes and charioteers of Homer; and this, or a short stick, was employed, even for beasts of burden and for oxen at the plow, in preference to the goad. The whip consisted of a smooth round wooden handle and a single or double thong; it sometimes had a lash of

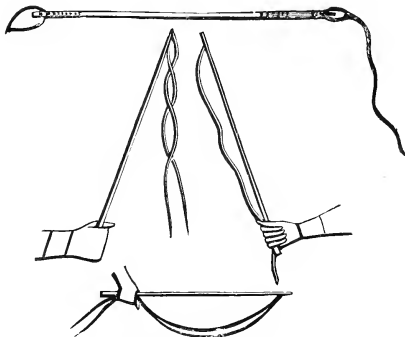

EGYPTIAN WHIPS.

leather or string about two feet in length, either twisted or plaited; and a loop being attached to the lower end, the archer was enabled to use the bow while it hung suspended from his wrist."¹ This practice rendered the whip readily available in case of danger, when the warrior, by whipping up his horses, might escape. Some of these whips were elegantly braided, and otherwise ornamentally made, as may be seen from the bass-reliefs.

The next engraving represents an archer, who at the same time is his own charioteer, with a whip suspended from his wrist, and the reins tied around his waist, in the act of discharging an arrow from the bow against an enemy. This expedient seems to have answered a very good purpose in extreme cases, where accident had overtaken the charioteer; but it must not be taken as the general mode in ancient warfare, since it entails more labor upon the warrior than is compatible with prudence.

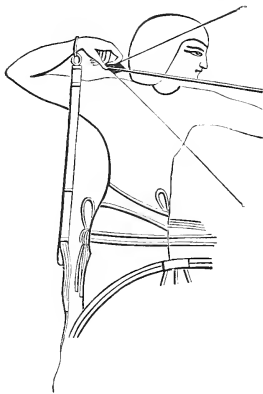

WHIP SUSPENDED FROM WRIST.

From Plates LIII to LIX, inclusive, Rossellini gives us another series of pictures, representing the further battles, victories, and triumphal processions of the same monarch.² Of the first plate only a fragment remains. On the second is the representation of a chariot, in which a warrior stands, the sides of which are quite open, so much so that his legs are plainly seen,—then, apparently, the fashionable mode of construction,—holding a bow in one hand and a sword in the other, with one foot forward on the pole in bracing attitude. Alongside of the chariot is a captive, holding a broken bow in his left hand, having the fingers of the other wide-spread, pleading for mercy. All around are the wounded, the dying, and the dead, pierced by the fatal arrow. On the third is the representation of a triumphal procession, where the

¹ Wilkinson's *Ancient Egyptians*, Vol. I, p. 372.

² In the Tuscan work this series is thus introduced: "Sequito della battaglia conquistata di Memphtha I, rappresentata in grandi basso-relievi sulla parete esterna sud-est dell' edificio Karnac." This king was the successor of Tethmosis (*circa* B. C. 1500), ruling over Egypt about thirty years. He appears by birth to have been a Theban.

hero, holding the reins in his left hand, clinches the whip and sword with the right, while a host of chained captives, with emblems of degradation fixed on their foreheads, march in the van. At the front and rear ends of the chariot are suspended a number of the heads of slain enemies, a profusion of lotus flowers being shown at different points.

The most interesting of the series (Pl. LVIII) portrays with much interest a triumphal procession of this same king (Meneptah I). Some portions of the original are destroyed, yet sufficient remain to give us a correct impression of what the artist meant to illustrate. The victor, with a wreath on his brow, is seen just stepping into his chariot, the sides of which are quite open, showing an unusual number of side-braces, and leading after him a portion of the prison-

TRIUMPHAL PROCESSION OF MENEPTAH I.—TEMPLE OF KARNAK.



ers set apart for this special purpose. Near the king are three manacled soldiers, conquered in battle. Behind follow two chariots, in which are mounted several other prisoners, likewise having their arms bound. In front of the chariot, in the original picture (omitted in ours), other prisoners are represented on the march, with grief and sorrow strongly depicted in their countenances.



RAMESSES II IN BATTLE.—FROM BEIT-UALLI, IN NUBIA.

The next in succession, according to the monuments, is *Rameses II.*¹ He is supposed to have reigned over Egypt fourteen years, being

¹ He is called, by ancient historians, *Armais* and *Armesses*. He flourished about A. M. 2426, B. C. 1579.

by birth a Theban. His victories are given in bass-relief on the walls of a temple at Beit-ualli, in Nubia. The prominent figure in the engraving represents the king—the shape of the cap on his head leaving no doubt of his rank in this instance—standing in his chariot in a warlike attitude, having seized two of his opponents by the hair, at the same time holding a bow in the left hand and an uplifted falchion in the right, indicating his intention of severing from their bodies the heads of his victims, several wounded soldiers lying disabled beneath the horses. The Egyptians have been credited with having exercised clemency towards a foe; but we find here, on the contrary, that the victims, although still living, have been lashed beneath the pole of the chariot, and thus tortured, even in the progress of a battle. In the bass-relief from which the chariot is copied, the enemy is observed, in confusion and dismay, in great numbers fleeing from the king. About twenty years are supposed to have intervened between the drawing of the above chariot and the one represented on page 35, and yet there is very little difference in them. The side of this last is not quite as much open, and the wheels appear to be iron, which we are told were sometimes used.

The horse-blanket was not unknown to the Egyptians. At first it appears to have been very simple and plain in design, but after it came into general use it assumed more pretentious proportions than it did formerly, and was elaborately woven in colors. It would appear that the harness for curries and that for war-chariots were nearly alike, and the pole in either case was supported by a curved yoke, the end being attached to the yoke

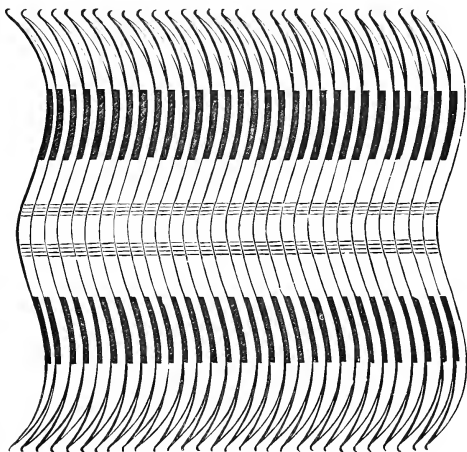

EGYPTIAN HORSE-BLANKET.

by a strong pin, bound with straps or thongs of leather to render it still more secure. The yoke, resting on a small, nicely padded saddle, was firmly fitted into a groove of metal, and the saddle placed upon the horse's withers, furnished with girths and a breast-band, was surmounted by an ornamental knob, in front of which a small hook

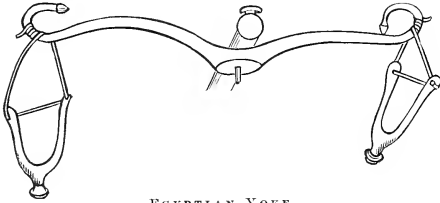

EGYPTIAN YOKE.

secured it to the bearing-rein. The driving-reins passed through a thong or ring at the side of the saddle, and thence over the projecting extremity of the yoke, the same thong securing the girths, even appearing

in some cases to have been attached to them. In the war-chariots, a large ball placed on the pole projected above the saddle, which was intended either to give a greater power to the driver, by enabling him to draw the reins over a groove in its center, or was added solely for an ornamental purpose, like the fancy head-dresses of the horses, and fixed to the yoke immediately above the center of the saddle, or rather to the head of a pin which connected the yoke to the pole.¹

Among the enemies of Rameses II were the Tokkari, whom he con-

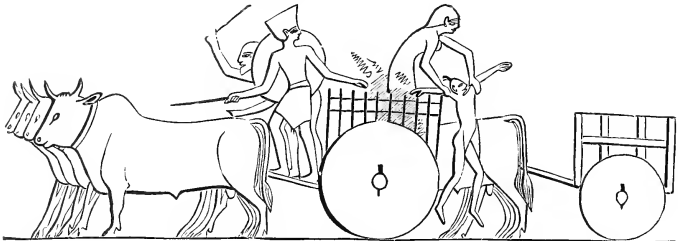

CAPTURED CARTS OF THE TOKKARI.

quered in battle, the ancient form of whose carts has been preserved on the monuments. These people, we are told, "wore a helmet in form and appearance very much resembling those in the sculptures of Persepolis. It appears to have been made of a kind of cloth marked

¹ Wilkinson's *Ancient Egyptians*, Vol. I, p. 379.

with colored stripes, the rim adorned with a row of large beads or other ornamental devices, and was secured by a thong or ribbon tied below the chin. They had also a round shield and short dress, frequently with a coat of armor similar to that of the Shairetana. Their offensive weapons consisted principally of a spear, and a large, pointed knife or straight sword. They sometimes, though rarely, had a beard, which was still more unusual with the chiefs; their features were regular, the nose slightly aquiline; and whenever their Egyptian artists have represented them on a large scale, the face presents a more pleasing outline than the generality of these Asiatic people. They fought, like the Egyptians, in chariots, and had carts or wagons, with two solid wheels, drawn by a pair of oxen, which appear to have been placed in the rear, as in the Scythian and Tartar armies, and were used for carrying off the old men, women, and children in defeat."¹ At one time these Tokkari would seem to have been the allies of the Egyptians, and a very brave and energetic people.

In the Tuscan work of Rossellini are several plates copied from the monuments, illustrative of the conquests of the Egyptians in Central Africa, under Rameses III.² Many of the chariots, particularly those on Plate LXX, are represented with extension fronts, similar to that shown on page 54. The faces of the enemy are decidedly African, and that there might remain no room for doubt on this point, the ancient artist has added to his design numerous palm-trees and monkeys. These bass-reliefs give us some idea of Egyptian power under the government of this monarch. It is said that he carried his conquests into Asia and Africa, enforcing tribute even from some portions of the Assyrian empire; and such was the increase in the

¹ Wilkinson's *Ancient Egyptians*, Vol. I, pp. 392, 393.

² The plates are six in number, from LXX to LXXV inclusive, and copies from the originals in bass-reliefs, at Seboah, in Nubia. The battles they perpetuate took place B. C. 1565, in the interior of Africa. This king (Rameses III), having eclipsed the grandeur of Orsortasen, — one of the Theban rulers, assigned to the seventeenth dynasty, — became ever after the traditional Sesostris of Egyptian history with the Greek authors. In the eighteenth dynasty, lasting about three hundred and forty-eight years, during the reigns of the Thothmes, Amunophis, Rameseses, and the Menepthahs, the Egyptians, having extended their conquests far into Asia and Africa, thereby increased the glory of the nation; but their fame was subsequently still further increased by Rameses IV in the nineteenth dynasty. This last-mentioned king was known to ancient historians as Sethos-Egyptus.

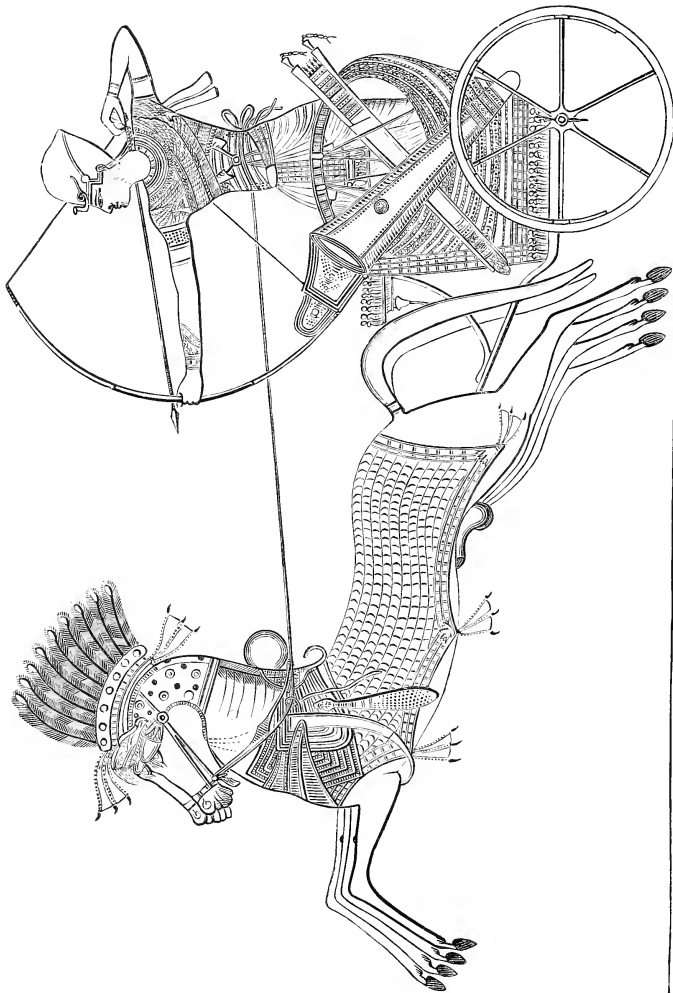

RAMESES III IN HIS CHARIOT.—BASS-RELIEF FROM A TEMPLE AT ABOO-SIMBEL.

wealth of the nation at this period, that we find the horses covered with trappings and blankets really beautiful, even the bow of the warrior having taken a graceful curve, in contrast with those of an earlier date. The wheels of the chariots likewise differ widely from those heretofore noticed, having still the six spokes in the hub, but made gradually tapering until they enter the felloes, thereby retaining the strength, while improving the appearance.

The engraving opposite is copied from a very fine bass-relief on the walls of a temple at Aboo-simbel, in Nubia.¹ It represents Rameses

¹ A recent visitor to the Temple of the Sun, at Aboo-simbel, says: "On the banks of the river Nile, near the second cataract, in a wild and desolate portion of Nubia, remote from the habitation of man, stands the grand temple of Aboo-simbel. This remarkable relic of antiquity was erected during the time of Rameses the Second, who ruled over Egypt. . . . Its exterior is composed of solid rock, preserved in its natural shape, and for many hundred years the entrance has been completely closed by the sands of the desert. It is only within the present century that this temple has been reopened, since which time repeated efforts have been made to arrest the progress of the sand, which persistently returns with the frequent Khamseen winds to hide the narrow portal. The changed topography of the country enables the elements to protect this strange monument of the past, and it is not improbable that as long as Nubian rocks and mountains last, so long will Aboo-simbel stand. At the entrance are two immense colossi representing Rameses the Second (Rameses III?). They are seated on massive thrones cut into the rock in such a manner as to present the appearance of grim guardians to the sacred temple. Their total height is about sixty-six feet without the pedestals. To form an accurate idea of their size, it may be well to state that the ear of each colossus measures three and a half feet, the forefingers three feet, and the lower portion of the arm, from elbow joint to finger end, has a measurement of fifteen feet. The height of the façade of the temple is estimated at one hundred feet; but as a portion of the base still remains hidden, it is impossible to determine the precise distance with accuracy. The interior of the temple is adorned with works of art peculiar to the period, with carvings and hieroglyphics of an historical character. The principal hall is supported by eight Osiride pillars, while beyond it is a second hall, from which diverge numerous corridors leading into ten side rooms and the adytum. In the center of the adytum is an altar, and at the upper end are four statues in relief. Attached to the columns in the great hall are eight colossi, each seventeen feet in height without the cap and pedestal. Upon the walls are numerous pictorial illustrations, in colors, of battle-scenes and conquests of Rameses the Second. A portion of the space is also occupied by a large tablet containing the date of this monarch's first year's reign. . . . In a niche over the entrance to the audience-chamber is a statue of 'Re' (the Sun), who was the god of the temple and the protector of the place. To this statue the king is represented as offering a figure of Truth. The Theban trial also occupies a prominent place here, as well as Osiris and Isis. From the center entrance to the innermost chamber of this temple, the total depth of the excavation is about two hundred feet, and not a ray of sunshine ever penetrates the darkness which pervades the place. To visit Aboo-simbel we were compelled to wade knee-

III as standing erect in a richly colored ornamental chariot, with high side quarters, having six braces stretching from the floor to the nave, making it very strong and firm. In front of the body is a fixture of singular form, used as the rest for a bow-case. The wheel is beautifully drawn, and is held on the axle-tree by a linchpin of no ordinary design. The horses are richly furnished with trappings and handsomely covered with blankets, but in many respects the picture is faulty in perspective; for instance, the warrior looks as though he stood on the off side of the chariot, while drawing his bow with the wrong hand.

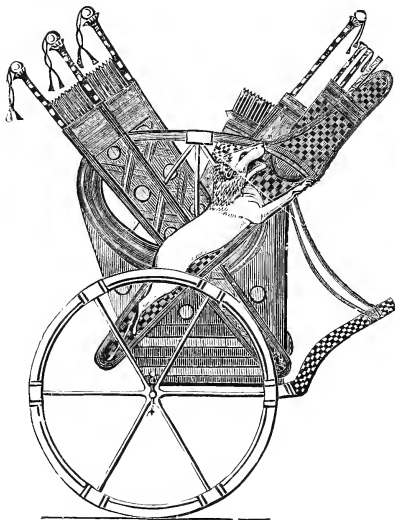

FULLY EQUIPPED WAR-CHARIOT.

On some of the bass-reliefs there is a grand display of battle-chariots, several with the effigy of a lion on the side, the tails of which curve with the openings, and likewise having embellished bow-cases, one example of which is shown in the accompanying illustration.

The next ruler over Egypt was Menepthah II, a son of the last monarch. Several bass-reliefs are still extant illustrative of prominent points in the history of his reign, where chariots are shown, but they do not exhibit sufficient novelty for a more extended notice in this place. We

deep through sand for a distance of about a hundred rods up hill. Crawling on hands and knees through the narrow hole which admitted us into the interior, we soon found ourselves in the gloomy recesses of the temple. Following our Arab guides, who led the way with flaming torches, we passed through the corridors and rooms already described. In the prosecution of our archaeological investigations we were greatly terrified by myriads of bats, which, disturbed by the flaming torches of our guides, flew about us, occasionally striking us in the face, and exhibiting unmistakable evidence of their rage at our invasion of the sacred precincts of the temple."

therefore pass on, and notice some incidents in the life of the next king, Menepthah III (*circa* B. C. 1496), seventy years after those recorded of Rameses III. In the engraving, copied from a bass-relief on the walls of a palace at Medènet Habòo,¹ Thebes, the king is represented as standing upright in a chariot, fully armed and equipped for war, accompanied by soldiers, well provided with spears and shields. Two attendants of the king are seen walking behind the chariot, carrying flabellas made of ostrich feathers, answering either for umbrellas or fans, the use of which pertained exclusively to royalty. This king and his immediate successors, who were Thebans, carried their conquests as far as Nigritia in Africa, into Asia Minor, to Cholchis on the Euxine Sea, and through Central Asia into Hindostan. The exodus of the Israelites from Egypt is supposed to have taken place under the rule of this monarch.

According to Herodotus, the military ranked next to the priests, as these last did next to the king, the king being but a little inferior to the gods themselves.² To the soldiers, by an edict of Sesostris (Menepthah III), were assigned certain portions of land, amounting to about eight acres, which they selected for themselves. Diodorus tells us this privilege was given "that those who exposed themselves to danger in the field might be more ready to undergo the hazards of war, from the interest they felt in the country as occupiers of the soil; for it would be absurd to commit the safety of the community to those who possessed nothing which they were interested in preserving."³ The soldiers paid no taxes, nor could they be imprisoned for debt, in which case the state might lose their services. From youth they were educated in the art of war, each man being obliged to provide himself with the necessary arms, both offensive and defensive, and all the other necessary requisites for an active campaign, at a moment's call, or to suppress a rebellion should such arise.

The Egyptian army was made up of archers of undoubted skill. These fought either dismounted or from a chariot, in both wings of the army, the heavy infantry being in the center, these last being divided

¹ Medènet Habòo was a place of considerable importance before the Arabs invaded Egypt, and still boasts of an astonishing collection of gigantic and palatial edifices.

² Herodotus, B. II, 164.

³ Diod., B. I.



MENEPTAH III MARCHING AGAINST AN ENEMY. — FROM MEDÉNET HABDO.

into regiments. Wilkinson observes that, "though Egyptian horsemen are rarely found on any monument, they are too frequently and positively noticed in sacred and profane history to allow us to question their employment, and an ancient battle-ax represents a mounted soldier on its blade. The infantry was made up of bowmen, spearmen, swordsmen, clubmen, and slingers, under regular discipline, divided into battalions and companies under appropriate officers. When in battle array the heavy infantry formed an impregnable phalanx, armed with spears, falchions, and shields, the bowmen as well as the light infantry acting either in line or broken columns, according to the nature of the fields. To each battalion or company was assigned a particular standard, borne aloft, with suitable device thereon, to which a superstitious respect was shown. The standard-bearers were selected from men of known valor, and distinguished by a peculiar badge, hung from the neck, in some cases showing two lions, emblematical of courage. The royal standards, as well as the 'flabella' before mentioned, were carried either by the princes, or the sons of the nobility holding the rank of generals, acting likewise as aids-de-camp on the field, and prominent officers in other processions, civil and religious. Some bore the state fans behind the king, when he visited the temple and on other public occasions; others, according to rank, carried his scepter or waved the flabella before him, either on his right or left hand.

"The offensive weapons were bows, spears, two kinds of javelins, slings, a short sword, dagger, knife, falchion, battle-ax, hatchet, pole-ax, clubs, and curved sticks. The defensive armor consisted of a metal helmet, a cuirass, or coat of armor made of metal plates or quilted with metal bands, and a large shield. These shields were about half the length of the man, and double their own breadth, generally covered with bull's hide, the hair side outwards. The frame was wood strengthened by metal pins of the form shown on the opposite page, where soldiers are seen on the march. These were suspended on the shoulders by means of thongs, or held in the hand by a handle, either horizontally or vertically."¹

¹ *Ancient Egyptians*, Vol. I, p. 345. The same author tells us that "when in battle, a general had a number of attendants in readiness (see Homer, *Iliad*, B. IV, v. 226-231), whenever he dismounted from his car, to lead his troops over hilly and precipi-

The Egyptians appear to have had baggage-carts for the conveyance of war material, much like those in common use by the paviers of modern cities. The annexed engraving is copied from a bass-relief found on an Egyptian monument, having a very high six-spoked wheel and a curved-roof box. In front of the box is a low seat, from underneath

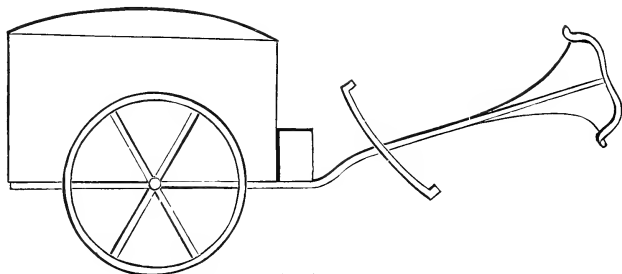

EGYPTIAN BAGGAGE-CART.

which protrudes a crooked drag-pole. This cart or baggage-wagon seems to have been very well adapted for the purpose designed, and was probably drawn by hand over the battle-field and in short marches. The design appears to have given some writers much trouble in assigning to it its proper use. A little reflection ought to have settled that question long ago.

The next illustration is copied from a bass-relief which exhibits Menepthah III in procession to the temple of Amun, to return thanks for success in battle. The chariots, although belonging to the same monarch, are of very different model, the rounded corner being in front instead of back. The chariot in advance is managed by a sacerdotal personage carrying a standard, on which is fixed the likeness of the god, the whole being guarded by soldiers. The king's chariot comes next. The horses are carefully and tastefully furnished with blankets and other trappings. The driving-reins run through a kind

tous heights inaccessible to chariots, to the assault of fortified towns or for any other purpose. They took charge of the horses, and keeping them in some secure place, they awaited his return or followed at a short distance; and a second car, with fresh horses, was always ready in the rear, in order to provide against accident, or the still less welcome chance of defeat." King Josiah, at the battle in the valley of Megiddo, being wounded, "was put into the second chariot that he had; and they brought him to Jerusalem."—2 *Chron.*, ch. xxxv, v. 24.

MENEPHTAH III PROCEEDING TO THE TEMPLE OF AMUN, MEDJENET HABOO.



of turret, and are held by the king very gracefully. A dog is seen in the procession, trotting along at an easy pace, seemingly well pleased with the surroundings.

Wilkinson says that "when the victorious monarch, returning to Egypt after a glorious campaign, approached the cities which lay in his way from the confines of the country to the capital, the inhabitants flocked to meet him, and with welcome acclamations greeted his arrival and the success of his arms. The priests and chief people of each place advanced with garlands and bouquets of flowers; the principal persons present addressed him in an appropriate manner; and as the troops defiled through the streets or passed without the walls, the people followed with acclamations, uttering earnest thanksgivings to the gods, the protectors of Egypt, and praying them forever to continue the same marks of favor to their monarch and their nation.

"Arrived at their capital, they went immediately to the temple, where they returned thanks to the gods, and performed the customary sacrifices on this important occasion. The whole army attended, and the order of march continued the same as on entering the city. A corps of Egyptians, consisting of chariots and infantry, led the van in close column, followed by the allies of the different nations who had shared in the dangers of the field and the honor of the victory. In the center marched the body-guards, the king's sons, the military scribes, the royal arm-bearers, and the staff-corps, in the midst of which was the monarch himself, mounted in a splendid car, attended by his fan-bearers on foot holding over him the state flabella. Next followed other regiments of infantry with their respective banners, and the rear was closed by a body of chariots. The prisoners, tied together with ropes, were conducted by some of the king's sons, or by the chief officers of the staff, at the side of the royal car. The king himself frequently held the cord which bound them, as he drove slowly in the procession; and two or more chiefs were sometimes suspended beneath the axle of his chariot, contrary to the usual humane principles of the Egyptians, who seem to have refrained from unnecessary cruelty to their captives, extending this feeling so far as to rescue, even in the heat of battle, a defenseless enemy from a watery grave.¹

"Having reached the precincts of the temple, the guards and royal

¹ For an illustration of this practice, see page 36.

attendants, selected to be representatives of the whole army, entered the courts, the rest of the troops, too numerous for admission, being drawn up before the entrance, and the king, alighting from the car, prepared to lead his captives to the shrine of the god. Military bands played the favorite airs of the country, and the numerous standards of the different regiments, the banners floating in the wind, the bright luster of arms, the immense concourse of people, and the grandeur of the lofty towers of the temple, decked in their bright-colored flags streaming above the cornice, presented an imposing scene. But the most striking feature of this pompous ceremony was the brilliant cortege of the monarch, who was either borne in his chair of state under a rich canopy, or walked on foot, overshadowed with rich flabella or fans of waving plumes. As he approached the inner gateway, a long procession of priests advanced to meet him, dressed in their robes of office, censers full of incense were burnt before him, and a sacred scribe read from a papyrus roll the glorious deeds of the victorious monarch, and the tokens he had received of the divine favor. They then accompanied him into the presence of the presiding deity of the place, and having performed sacrifice and offered suitable thanksgivings, he dedicated the spoil of the conquered enemy, and expressed his gratitude for the privilege of laying before the feet of the god, the giver of victory, those prisoners he had brought to the vestibule of the divine abode.

"In the mean time the troops without the sacred precincts were summoned by sound of trumpet to attend the sacrifice prepared by the priests, in the name of the whole army, for the benefits they had received from the gods, the success of their arms, and their own preservation in the hour of danger. Each regiment marched up by turn to the altar temporarily raised for the occasion, to the sound of the drum, the soldiers carrying in their hands a twig of olive, with the arms of their respective corps; but the heavy-armed soldier laid aside his shield on this occasion, as if to show the security he enjoyed in the presence of the deity. An ox was then killed, and wine, incense, and the customary offerings of cakes, fruits, vegetables, joints of meat, and birds were presented to the god. Every soldier deposited the twig of olive he carried at the altar, and as the trumpet summoned them, so also it gave the signal for each regiment to withdraw, and cede its place to another. The ceremony being over, the king went in state to

his palace, accompanied by the troops, and having distributed rewards to them, and eulogized their conduct in the field, he gave his orders to commanders of the different corps, and they withdrew to their cantonments, or to the duties to which they were appointed."¹

The same author says that "the Egyptians frequently coursed with dogs in the open plains, the chasseur following in his chariot and the huntsman on foot. Sometimes he only drove to cover in his car, and having alighted, shared in the toil of searching for the game, his

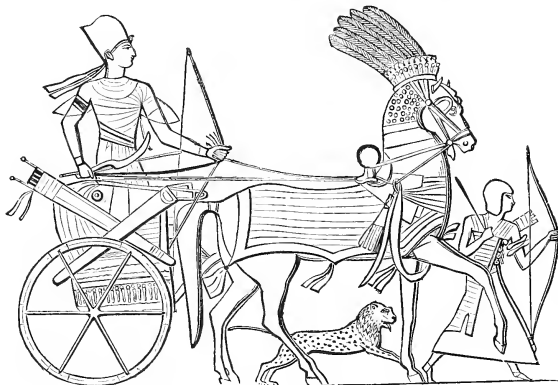

EGYPTIAN HUNTING-CHARIOT.

attendants keeping the dogs in slips, ready to start them as soon as it appeared. The more usual custom, when the dogs threw off in a level plain of great extent, was for him to remain in his chariot,

and urging his horses to their full speed, endeavor to turn or intercept them as they doubled, discharging a well-directed arrow whenever they came within its range.

"The dogs were taken to the ground by persons expressly employed for that purpose and for all the duties connected with the kennel, and were either started one by one, or in pairs, in the narrow valleys or open plains; and when crossing on foot, the chasseur and his attendant huntsmen, acquainted with the direction and sinuosities of the torrent beds, shortened the road as they followed across the intervening hills, and sought a favorable opportunity for using the bow, or enjoyed the course of the level space between them.

"Having pursued on foot, and arrived at the spot where the dogs

¹ Wilkinson's *Ancient Egyptians*, Vol. I, pp. 277-279.

had caught their prey, the huntsman, if alone, took up the game, tied its legs together, and hanging it over his shoulders, once more led by the hand the coupled dogs, in precisely the same manner as the Arabs do at the present day. But this was generally the office of persons who carried the cages and baskets on the usual wooden yoke, and who took charge of the game as soon as it was caught, the substitutes for our game-carts being in proportion to the proposed range of the chase and the number of head they expected to kill. Sometimes an ibex, oryx, or wild ox, being closely pressed by the hounds, faced round and kept them at bay with its formidable horns, and the spear of the huntsman as he came up was required to decide the success of the chase. It frequently happened, when the chasseur had many attendants, and the district to be hunted was extensive, that they divided into parties, each taking one or more dogs, and starting them on whatever animal broke cover. Sometimes they went without hounds, merely having a small dog for searching the bushes, or laid in wait for the larger and more formidable animals, and attacked them with the lance."¹

About fifty-seven years later (B. C. 1474), *Rameses IV* occupied the throne of Egypt, he being placed in the nineteenth dynasty by historians. The series of pictures illustrative of his deeds on the walls of an Egyptian temple are numerous. One represents the monarch in his chariot on a lion hunt, one animal being represented laying on his back, while another is seen plunging into the forest, both having darts fastened in their bodies. The king's chariot differs in model from the one used by *Menepthah III*, the front end standing nearly perpendicular, and having a rounded back corner, with a very small opening in the side panel. In one of these pictures the king sits at ease in his chariot, with his back turned towards the horses, while the scribes number the slain in a late victory, by counting the severed hands, now collected for the purpose into one heap.

Some of these bass-reliefs, in imitation of his predecessors, represent *Rameses IV*, according to Egyptian custom, as offering his victims to *Amun*. One of these depicts a solemn procession on its march to the sacred temple, some of the captives, either dead or alive, being slung under the body of the royal chariot, others manacled being marched

¹ Wilkinson's *Ancient Egyptians*, Vol. I, p. 218.

along in the most humiliating attitudes the victorious rulers could possibly devise. Of the humane character of the Egyptians we have before taken notice, and in the absence of testimony to the contrary,

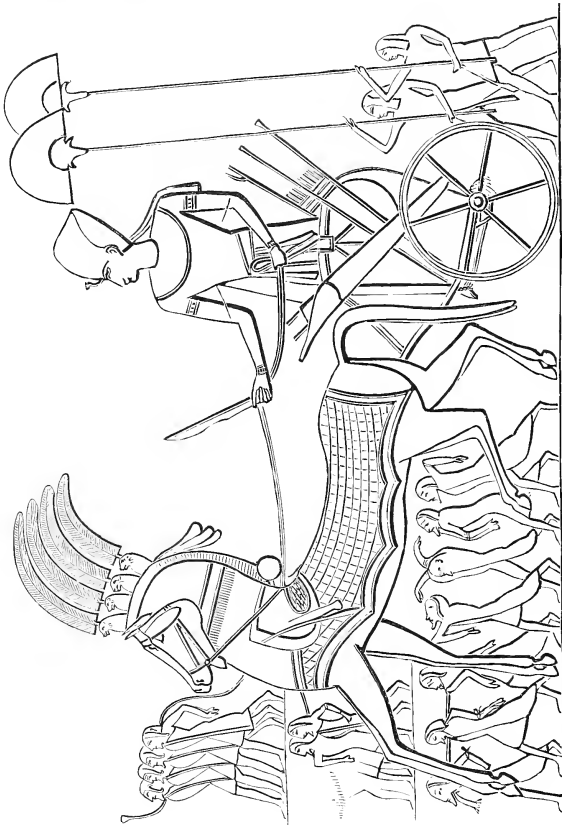

RAMESES IV CONDUCTING CAPTIVES TO THE TEMPLE OF AMUN.

charity leads us to conclude that the victims under the chariot were killed in battle, and only shown on such occasions as trophies of success, however inexcusable such a display would be at the present day. That some of the Egyptian rulers were cruel will scarcely admit of a

doubt. Diodorus tells us that "Sesostris [Rameses III] tarnished his glory by an act of great oppression, compelling captive monarchs to draw his chariot as he proceeded to celebrate his triumphs"; and the Theban artist, as we find in the illustration on the opposite page, has not been ashamed to introduce the representation of a faulty custom in bass-relief on the walls of the palace at Medénet Habò. In this charge of cruelty Diodorus is indorsed by Pliny and others.¹

The next illustration, representing a battle-scene, is copied from a bass-relief on the walls of the Temple of Luxor, Thebes.² It bears unequivocal evidence of having been executed with much pains, as far as finished. The body of the chariot is altogether different from any yet given in this volume, having the form of a crucible with an extension front, to permit the occupants to escape more easily in case of danger. Indeed, an examination impresses the mind with an idea that this might be the work of a potter instead of a chariot-maker, lacking entirely those exterior ornaments we are accustomed to find in the chariots of previous years. Even the bow-string and arrow are needed to complete the picture of a warlike hero. The head-gear and other trappings of the horses are likewise missing, the details seemingly being too tedious a labor for the artist.

¹ Diodorus Siculus, Lib. I, v. 58, and Pliny, Lib. XXXIII, v. 15, the latter of whom writes: "*Sesostri Ægypti rege tam superbo, ut proditor armis quibusque sorte reges singulos e subjectis pungere curram solitus atque ita triumphare.*" Herodotus, who writes from personal inspection, tells us that this king (Sesostris) employed a great number of captives in digging canals, by which involuntary labor Egypt, which before was practicable throughout, was rendered unfit for horses and carriages. Herodotus, B. II, 108.

² From "Description de l'Égypte, ou Recueil des Observations et des Recherches qui ont été faites en Égypte pendant l'Expédition de l'Armée Française. Publié par les ordres de sa Majesté l'Empereur le Grand. A Paris, de l'Imprimerie Impériale, 1812." The ruins of the Temple of Luxor now present but the mere skeleton of the original edifice, standing on an elevated foundation, ten feet high, walled in with brick. It appears originally to have been eight hundred feet long and two hundred and eight feet broad, located on the eastern bank of the Nile, near the river. This once grand and imposing structure was erected by Rameses II and Menepthah III. Some have supposed the ruins the remains of a temple, others of a palace. On the front of the principal entrance are shown in bass-reliefs the picture on the next page. Although defective in some respects, they have been ranked high as sculptures in the catalogue of art, being cut in relief of a peculiar kind, at a later date than any of the preceding, to commemorate the victories of the ancient Egyptians over some foreign enemy, but whether Indian, Persian, or Bactrian has never been satisfactorily determined. The fallen victim being naked would seem to indicate that he belonged to some very warm climate, probably Africa.

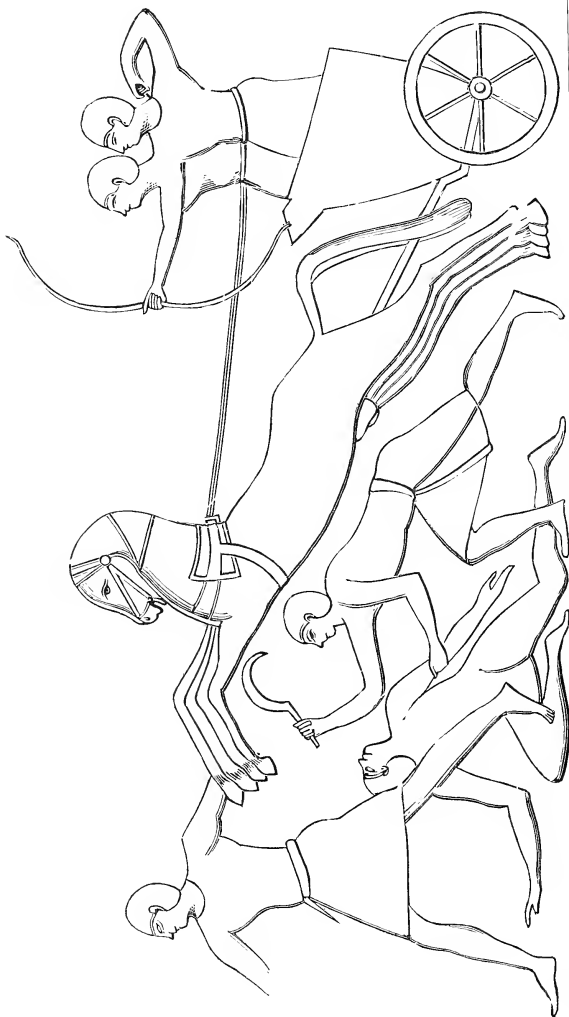

BATTLE-SCENE FROM THE TEMPLE OF LUXOR.

Another chariot of more solid construction, captured from some contemporary nation with whom the Egyptians carried on a warfare (probably known as the Rot-u-n), differed very much from the Egyptian. The mode of hitching the horses to the car (even if the number was three, instead of two, as afterwards used by the Grecians) was altogether unlike that of their captors, as is proved from the singular formation of the yoke attached to the pole in the hands of the negro.

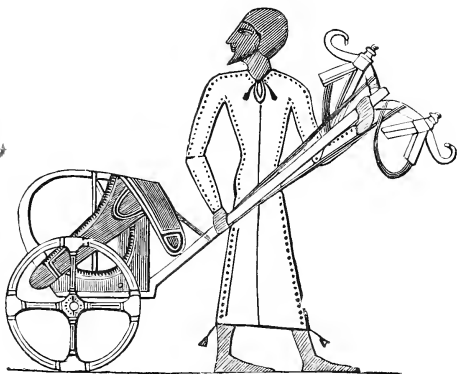

CHARIOT OF THE ROT-U-N.

Our research into Egyptian history has hitherto discovered little else than chariots. There have, however, been discovered one or two exceptions, among these a kind of plaustrum, of which we furnish an engraving. The manner of construction is very much like that of the war-chariot, the side being two thirds closed, similar to the chariots of a later age. Here oxen take the place of horses. The bow-case evinces that even in ancient times it was necessary to carry arms as a protection against the assaults of highwaymen. The harness and pole were much the same as those used with the war-chariots. Besides the driver, a groom sometimes attended the vehicle on foot to take care of the team. The picture represents him as feeding the animals even while on the march. When traveling, the vehicle was furnished with an umbrella for the protection of the passenger against the intense rays of the sun. Umbrellas were seldom used for any other purpose, the scarcity of rain and the dryness of an Egyptian climate being proverbial.¹ The picture under consideration may possibly represent an

¹ Rain is almost unknown in Upper Egypt, and formerly it never rained more than five or six times in the year on the delta of the Nile. Mehemet Ali, the viceroy, recently caused twenty million trees to be planted on this delta; the result is, the rainy days have since increased to forty.

Ethiopian chariot conveying an Ethiopian princess through Upper Egypt on the way to Thebes, where the court then resided; but



EGYPTIAN PLAISTRUM.

whether it was on the occasion of her projected marriage with Menepthah III (B. C. 1496), or merely to pay homage to him, is uncertain. In the original bass-relief from which the plastrum was

selected, a large tribute is represented as being brought from her countrymen—the Cush—along with her, which seems to indicate that it relates to some visit of ceremony from a queen or princess of note. The fact that the charioteer and some other of the attendants are unmistakably Egyptian, suggests that the vehicle had been provided by some monarch for this special occasion, as was done when Joseph, at the instigation of Pharaoh, sent for Jacob and his family to bring them into Egypt.¹ In the Book of Genesis these plaustrum are called wagons² by the translators. Such were commonly used in Egypt for traveling purposes. Strabo appears to have performed the journey from Syrene, to the spot where he crossed the river to visit Philæ, in one of these vehicles. Besides the plaustrum, the Egyptians had the palanquin, with a canopy overhead, which was borne on the shoulders of slaves accustomed to such service.

In the Florentine Museum, Italy, there is, in good preservation, a genuine Egyptian chariot, composed of birch and iron, of which we give a correct representation on a reduced scale. The sides are entirely open, the floor being composed of rushes or flags, something after the pattern in which our ancestors bottomed their kitchen-chairs.

¹ Gen., ch. xlv, v. 16 *et seq.*

² Gen., ch. xlv, v. 19, 20; also, Gen., ch. xlv, v. 5.

An ingeniously applied piece of wood at the ends of the bottom-rail serves to bind the bottom-side and the cross-bar firmly together, while

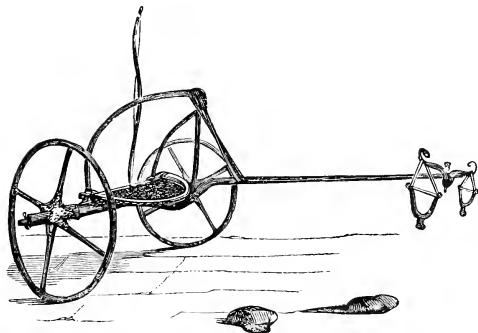

CHARIOT FROM THE FLORENTINE MUSEUM.

it furnishes additional solidity to the tenons of the nave. The warrior's bow is shown standing upright in the car. The yoke at the end of the pole is exhibited on a larger scale on page 38. This chariot unquestionably belongs to a much later period than any we

have yet introduced to the reader, — probably to the Ptolemaic age.

To somewhere about B. C. 300 belong the old fragments of an Egyptian chariot found by Dr. H. Abbot in a mummy-pit at Dashour, now preserved among the Egyptian curiosities of the New York Historical Society in New York City, consisting of a wheel and its wooden shooing, the back end of the shafts, one side and one end rail of the body. All these we have had engraved from photographs taken on the block, with such perfection that every mortise, tenon, and joint is truthfully preserved in the copies.

The wheel is two feet eleven inches high without, and three feet three inches with, the *wooden tire*, as restored on page 60. The hub, which is fourteen and a half inches long, five inches through the middle, and four and a half inches at the ends, has not the least appearance of ever having been burdened with an iron box ;

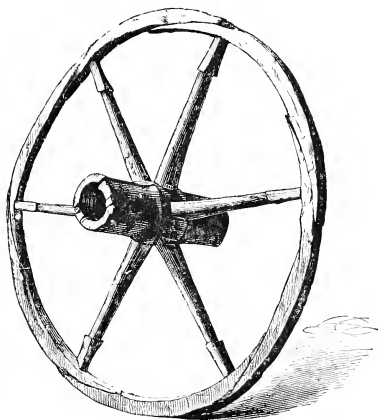

ANCIENT EGYPTIAN WHEEL.

and the jagged ends, particularly the front one, look as though they had undergone many hard rubbings from the linchpin, probably a wooden one, while revolving around an axle-tree. This axle-tree, allowing for wear, was about two and three quarters inches at the front end of the hub. The hub, which looks as though it had been turned in a lathe, is very much split, the effects of very hard usage. There are several "creases" in the hub, such as imprudent hub-manufacturers still turn, for the purpose of showing the wheelwright where to set the fronts of his spokes. In this wheel there is ample proof that *some* ancient ones rotated around the axle, and not with it, as some modern writers would have us believe, and who probably have been misled by studying the bass-reliefs, which in many cases seem to favor such a conclusion.

The spokes — we give a side view of one — have a very peculiar finish, highly ornamental. The photographer and engraver have both so faithfully executed their respective parts (as the reader may see) that the file-marks and indentations of the original have been successfully shown on the paper. Near the bottom of the spokes, all around, are spike-shaped mortises, the uses (if any other than ornamental they had) of which we are at a loss to conjecture. They may, as some suppose, have been made for the insertion of some kind of a brace for strengthening the wheel; but a close inspection of the mortises in this instance has not at all satisfied us that any such brace was ever employed. The mortise is two and a half inches long, the narrower portion of which is three eighths of an inch wide, and the wider seven eighths, located one and three eighths inches above the shoulder at the hub. The tenon at the hub is one and a half by three eighths of an inch, and, as may be observed in the engraving, is a little rounding at the shoulder. But that which strikes the eye of the practical mechanic most forcibly is, it has a square "tang" where it enters the felloe, — a thing known to the ancients, but now chiefly confined to the heavier class of work. The diameter of the spoke at the periphery of the hub measures two by one and three eighths inches, rounded in the old-fashioned manner, and apparently "finished" with a very coarse-cut file. The tenons for the felloes are one inch square, passing only about two thirds the distance through at the



SPOKE.

intersection of the lapped joints. There is no evidence that an auger was ever used in making mortises in the wheels or in any of the other fragments of this collection. Had such been the case, traces thereof would be found in the bottoms of the mortises, especially those in the felloes which do not extend through.

The felloes next claim our attention—and such felloes! The wear and tear the wheel has undergone lends enchantment to the picture. These felloes, six in number, meeting at the point of intersection with the spokes, as shown on page 57, are laid on overlapping each other, and are bound to the spokes by simple pressure from the wooden tire. These felloes, “got out” one and a half by one and a quarter inches, are about three sixteenths of an inch “half rounded down” on the sides.

The tire-shoeing bears a strong resemblance to our modern felloes, except that instead of dowels they are connected by a male and female

joint, extending from the inside to two thirds of the depth of the *tire* outward, so that it is hidden at the tread of the wheel. This tire is divided into six sections, forming as many joints, meeting, when placed around the wheel, half-way between the spokes, having twenty-five narrow mortises along the inner edge, varying from two and a quarter to two and three quarters inches in width. These mortises doubtless were made for the purpose of securing



WOODEN TIRE.

this tire upon the wheel by strips of hide or other flexible material, which not only served in securing the tire to the felloes, but likewise answered the purpose of binding the felloe more firmly at the joints, where, as contrived, some such provision was much required. The “tread” of this tire is one and a quarter inches wide, and the *tire* itself is two inches deep, looking as though it had seen much rough service over hard roads. This wheel we have put together as we

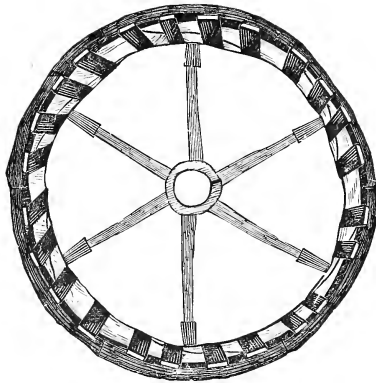

COMPLETED CHARIOT WHEEL.

body. Poles, originally attached to the sharpened ends, constituted a pair of shafts for a one-horse vehicle, which this chariot manifestly was. The camera, faithful to the original, as with the other relics, has not only given us the file-marks and position of the mortises, but the engraver has so skillfully done his work that in our picture even the color of the wood has been transferred to the paper in printing. At the back end this fragment is two by three inches in diameter, with three mortises each, respectively one and a quarter, one and three eighths, and one and a half inches long, by half an inch wide. Wilkinson says that the shafts complete were eleven feet long, which is reconcilable with the use of low wheels.

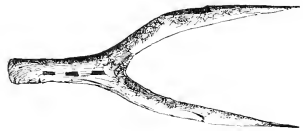

FRAGMENT OF SHAFTS.

¹ Iron was certainly known to the ancients, there being an Egyptian anvil in the British Museum precisely of the form now made, supposed to be over three thousand years old. That it was invented to the injury of mankind is thus shown by an old writer: "Lichas, a Spartan, coming to a smith at Tegea, looked attentively at the iron being forged, and was struck with wonder when he saw what was done. . . . Seeing the smith's two bellows, he discovered in them the two winds, and in the anvil and hammer the stroke answering to stroke, and the iron that was being forged, the woe that lay on woe, representing in this way that iron had been invented to the injury of man." — *Herodotus*, B. I, 68.

We now come to two fragments believed to represent an end and side rave of a chariot body. The next engraving probably represents an end rave with one of the tenons broken off. This is two feet and three inches long, and one and three quarters inches wide, with eight mortises of various widths ranged along the lower edge. The tenons at the



CHARIOT END RAVE.

ends were one by a quarter of an inch. A short distance from the tenons there are round holes three eighths of an inch in diameter, possibly for the insertion of cords, which, passing around the ends of the side raves, bound the whole firmly together. This was necessary, since a very light tenon was used, to avoid cutting away the rave in mortising. The curve in this rave is five inches, measured on a straight line with the inner side.

The duty assigned to the remaining fragment has somewhat puzzled us, but we conjecture that it represents the side rave. One very strong reason for this conjecture is found in the fact that the tenon at the end of the end rave (see above) and the mortise in the side rave match exactly, proving



CHARIOT SIDE RAVE.

that it belonged to the same chariot. This rave is likewise pierced with twelve mortises ranged along the lower edge, as in the other rave. The notch near the end, at the left hand, has been gashed to prevent the slipping of the cord used in giving additional support to the joint at the corner.

The timber in all these fragments is of the hardest and heaviest kind, so very solid that time and the worm seem to have made very little impression on them. As there was no timber grown in Egypt, this must have been imported from some other country, but of what species it is we are not able to decide.

The chariots of the Egyptians were built extremely light, particularly the body, which had a painted frame-work strengthened and ornamented with metal and leather bindings, like many described in Homer, resting on an axle-tree and the back end of the pole, which last was mortised into the axle-tree or a socket attached to it. Some chariots are shown by the monuments to have been inlaid with silver and gold, others painted; the latter, as might be expected the most

numerous, sixty-one of them being mentioned to nine of the former. The front was strapped to the pole to steady it, and when the horses were taken out, the pole was supported on a crutch, or the wooden figure of a man, representing a captive or enemy who was thought fitting for this degrading office. The greater portion of the sides and the whole of the back were open, the latter, indeed, entirely so, without any frame-work above. The hinder portion of the frame-work of the body commenced nearly in a line with the center of the wheel, and rising perpendicularly, or very slightly inclining backwards, from the base of the car, extended with a curved or rounded back corner, at the height of about two feet and a half to the front, serving as well for a safeguard to the quiver and bow-case as to the rider. To strengthen it, three thongs of leather attached to each side, and an upright piece of wood connected it with the base of the front part immediately above the pole where the straps before mentioned were fastened. The bow-case, as previously shown, was frequently ornamented with the figure of some animal or other device, and was placed in an inclined position pointing in a foreign direction with the flexible frame-work of the chariot, so that when the bow was drawn out the leather covering fell down and left the upper part of the chariot body an uninterrupted level. In battle this was of course a matter of small importance; but in the city, where the bow-case was considered an elegant part of the ornamental hangings of a car, and continued to be attached to it, they paid some attention to the position and fall of the pendent cover, deprived, as it there was, of its bow; for the civilized state of Egyptian society required the absence of all arms except when in actual service. The quivers and spear-cases were suspended in a contrary direction, pointing backwards. Sometimes an additional quiver was attached close to the bow-case, with a mace and other arms, and every war-chariot containing two men had the same number of them.

In the days of Solomon chariots and horses were exported from Egypt into Judea and Syria. The Hittites were also supplied from the same source.¹ No drawing of a chariot has been discovered on

¹ "And Solomon had horses brought out of Egypt. . . . And a chariot came up and went out of Egypt for six hundred *shekels* of silver, and an horse for an hundred and fifty; and so for all the kings of the Hittites, and for the kings of Syria, did they bring them out by their means." — *1 Kings*, ch. x, v. 28, 29.

any Egyptian monument dating further back than the eighteenth dynasty, B. C. 1822. Consequently our history is limited to a small space of time, which it is now too late ever to extend.

Probably no horses in ancient times excelled those of the Egyptians. Their beauty and strength attracted the notice of other nations. Solomon compares his love to a company of horses in Pharaoh's chariots.¹ Adam Clarke, in commentating upon the passage, translates it more literally: "I have compared the Lesusathi to *my mare* in the chariots or courses of Pharaoh."² This commentator tells us that Eastern nations preferred mares to horses, as being much swifter, more hardy, and able to go longer than either stallions or geldings. Nevertheless it is noticeable that the bass-reliefs from Egypt mostly represent *horses* "bound to the chariots" sculptured thereon.

The horse has been praised for his beauty in all ages, and the most beautiful woman of antiquity has been compared to a horse in a Thessalian chariot, by Theocritus.³ Among the ancients, horses were kept almost exclusively for war purposes, mules and asses being used as beasts of burden or for riding. Every reader of the Bible is acquainted with Job's description of the horse.⁴ Homer also has sung his praise,⁵ in which he has likewise been imitated by Virgil.⁶

¹ Canticles, ch. i, v. 9.

² "Though the Egyptian name of the horse was *shthor*, the *mare* was called, as in Hebrew, *sus* (pl. *susim*), which argues its Semitic origin, *fâras*, the *mare*, being still the generic name of the Arabian horse; and if its introduction was really owing to the invasion of the shepherds, they thereby benefited Egypt as much as by causing the union of the whole country under one king." — WILKINSON'S *Ancient Egyptians*, Vol. I, ch. 5.

³ "The golden Helen, tall and graceful, appears as distinguished among us as the furrow in the field, the cypress in the garden, or the Thessalian horse in the chariot." — *Theocritus*, Idyl XVIII, v. 28.

⁴ Job, ch. xxxix, v. 19-25.

⁵ There are two passages in Homer, nearly alike, descriptive of the horse, the one illustrating the character of Paris, the other Hector, — Homer's *Iliad*, B. VI, v. 506; B. XV, v. 263.

⁶ "Tum, si qua sonum procul arma dedere,
Stare loco nescit; micat auribus, et tremit artus,
Collectumque premens volvitur sub naribus ignem.
Densa juba, et dextro jactata recumbit in armo;
At duplex agitur per lumbos spina, cavatque
Tellurem, et solido graviter sonat ungula cornu."

VIRGIL'S *Georgics*, B. III, v. 83.

In modern times we find some who contend that the horse was only made to be ridden in the saddle, and that his devotion to other purposes is one of the necessities, perhaps, but also one of the abuses of civilization; that dragging vehicles from the shoulders by pulling is an occupation only fit for bullocks, and that where the horse is held in most esteem he is never dishonored by such employment.¹ This idea can only find indorsement among such nations as have no carriages, — a nation of barbarians.

We cannot well dismiss Egyptian vehicular art without presenting the reader with some general observations respecting it. And first we would remark, that no mechanical profession was ever looked upon as degrading or dishonorable among this ancient people. Every man had some profession assigned him by law, the son being obliged to follow the calling of his father. No change from the father's occupation was permitted to the son, nor could the same individual follow two trades at the same time. The consequences were that art reached a high state of perfection, each subsequent mechanic adding to his predecessor's excellence some ingenuity of his own. This wholesome institution, says a popular author, "taught every man to sit down contented with his condition, without aspiring to one more elevated from interest, vainglory, or levity."

"The fiery courser, when he hears from far
 The sprightly trumpets and the shouts of war,
 Pricks up his ears, and, trembling with delight,
 Shifts pace, and paws, and hopes the promised fight.
 On his right shoulder his thick mane reclined,
 Ruffles at speed, and dances in the wind.
 His horny hoofs are jetty black and round;
 His ehine is double; starting with a bound
 He turns the turf, and shakes the solid ground.
 Fire from his eyes, clouds from his nostrils flow;
 He bears his rider headlong on the foe."

¹ Apuleius, who wrote in the early part of the second century, says: "Even necessary haste sometimes admits of proper delay. . . . Those who have occasion to travel fast . . . would rather ride on horseback than sit in a car, on account of the annoyance of baggage, the weight of vehicles, the clogging of the wheels, the roughness of the track, the heaps of stones, the projecting roots of trees, the streams on the plain, and the declivities of hills. Wishing, then, to avoid all these retardations, they select a riding-horse of enduring powers and lively speed, strong to bear and a good goer, 'that sweeps at equal pace o'er hill and dale,' as Luellius says." — *Florida*, Sect. 21, Bohn's Ed.

That art was progressive with the Egyptian chariot-builders may be learned from a comparison of the earlier and later illustrations we have given in this chapter. The manner in which the workman carried on his operations has fortunately been transmitted to us in the bass-reliefs on the walls of an edifice erected by Thothmes III at Thebes.

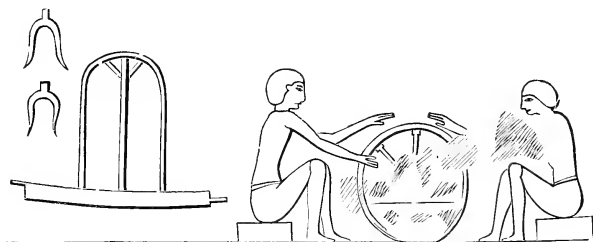

RIMMING A WHEEL.

The fact that such a subject was considered worthy of record is quite sufficient to brand it as honorable, as well as of the greatest importance. With the skillful builder of chariots rested the very life of the nation, as in chariots and horsemen the Egyptians put their trust in battle.

In the copy, although it is much defaced by time, we have the representation of two ancient wheelwrights at work, seemingly in the act of rimming a wheel. This, as may be observed, was put on in banded sections overlapping each other at the ends of the spokes. The original drawing, in a perfect state, represented an eight-spoked wheel, such as has already been seen in this chapter. The forked articles hanging upon the walls represent the ends of the shafts, such as have already been described on page 60, in connection with other fragments of a chariot. The other article represents an axle-tree and the bottom frame-work of a chariot-body. It is true, the journals of this axle-tree are not, in a mechanical sense, very perfect, but this probably is owing to the carelessness of the artist or his ignorance of architecture. For special reasons, as before observed, the axle-trees of war-chariots in ancient times were placed near the hind end of the body, under the impression that the chariot was less liable to be upset in an engagement.

In the next engraving we find the process of bending timber plainly

indicated by the manner in which the straight slips of wood are inserted between the two upright posts for shaping into rims. The effect of steam in rendering timber pliable was evidently early discovered by the ancients.

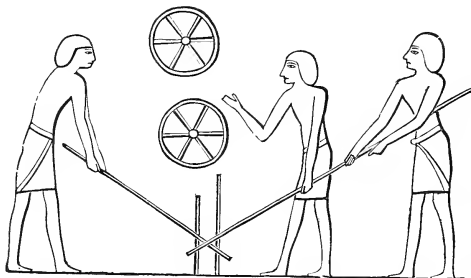

BENDING THE TIMBER FOR A WAR-CHARIOT.

That these workmen are constructing wheels for war-chariots is shown by the six-spoked wheels represented as hanging on the walls of the factory. A sitting posture when in the performance of work was not among

the ancients looked upon as disgraceful, it being universally practiced when practicable. This, too, like the previous figure, has seen the effects of age.

The third engraving is still further illustrative of the art as carried on in Egypt. Here we see one man engaged in rending a stick of timber by sawing, — a proof that the saw is a very old invention, — and another in carrying some bent portion of the chariot, perhaps the front rave of the body, three other like portions hanging on the wall.

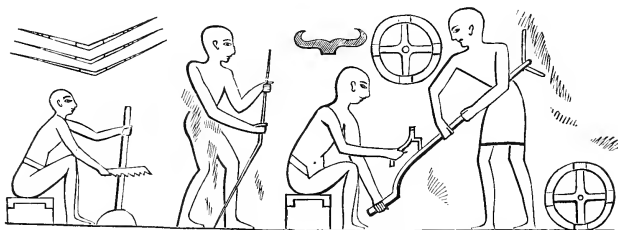

MAKING THE POLE AND OTHER PARTS OF THE CHARIOT.

The other two men are engaged in finishing a pole of a crooked shape, the advantages of which for a low-wheeled vehicle have been known from remote ages. A yoke hangs over the head of the workman with the adze at labor on the pole. The two four-spoked wheels would

seem to indicate that in this shop they are making pleasure-chariots. Just here we may be permitted to offer some general reflections regarding Egyptian wheels.

Upon the whole it must be conceded that, when compared with wheels of modern manufacture, those of ancient times were decidedly frail and weak. An example of their inefficiency has already been shown. The war-chariots of Egypt, according to the records on the monuments, had six spokes in each wheel, the business and pleasure carriages being represented with only four. We account for this difference by supposing that in battle, where success depended in a great measure upon the stability of the chariot, special care was taken to provide a strong wheel, while a weaker one was considered good enough for more peaceful employment, a four-spoked wheel in those days being much cheaper and lighter. It is evident that the ancient workmen made the "tang" of the spokes very light, that they might not unnecessarily weaken the rim at the point of insertion, consequently the ends of the spokes were soon broken off. To provide against this or any other mishap in conflict, provision was made for the safety of the king as well as his generals, by having an attendant at hand with an extra chariot, into which he could spring and renew the contest if judged advisable, or secure his safety by flight if necessary.

There is one very singular feature about the wheel previously mentioned, which is, that while the *rim* proper appears to have been bent into shape, the wooden tire was cut out from the solid timber. Now, wood was an excessively costly article in Egypt because of the scarcity, very little being grown there; consequently, unless for some special reason, an ancient chariot-maker would never have wasted his stock in "working out" his tire, when he could have obtained it by bending. Such material had to be imported from abroad, great quantities of it from Syria, rare woods constituting a portion of the tribute exacted from the conquered nations. Indeed, so highly were some kinds of wood esteemed for ornamental purposes, that painted imitations were often substituted for the poorer classes who could not afford to pay for the real article; and the doors, windows, and panels of houses, boxes, and various kinds of wood-work were frequently made of cheap deal or sycamore stained to resemble some of the rarest foreign woods. In view of these facts, although it may appear strange to some persons,

we infer that the Egyptians had found from experiment that a *bent* tire of wood was not as durable as one worked out, and that the waste of timber was more than compensated for in the advantages gained for the wheels.

We next come to the trimming and harness-making department of the business. This, too, we are able to illustrate from original sources, the bass-reliefs from the tombs. In this figure the left-hand mechanic is represented as engaged in trimming a chariot of about the time of King Menepthah I (*circa* B. C. 1600), which is indicated by the

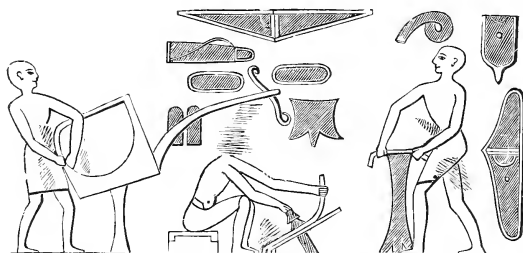

BINDING OR TRIMMING A CHARIOT-BODY.

rounded corner at the rear of the body. Another workman, whose head time or some more destructive vandal has taken off, is seen cutting out some portions of the material required in trimming his job. On the walls hang various articles necessarily used in completing the inside linings of a chariot, as well as a case for the bow and another for the quiver. The third man is probably employed in dressing the hide for harness-making and trimming, such being required in both occupations. This leather was afterwards dyed of various colors, and adorned with metal edges and studs. Lest it should be misunderstood, the Egyptians themselves have not neglected to point out to us what parts or divisions of the labor devolved upon both wood-workman and trimmer respectively. Here, while the chief workman displays his skill in putting in the lining, his assistant is employed in cutting and preparing the trimmings from leather, of which material chiefly the inside linings were composed. The ancient artist in bass-relief has distinctly given us to understand the nature of the material employed, by representing the skin of an animal, the soles of a pair of sandals, and other articles of leather as suspended on the walls of the workshop. In the hands of one we discover the identical half-circular knife, still in use by the modern mechanic, invented more than three thousand years ago.

CHAPTER II.

ASSYRIAN CHARIOTS AND OTHER VEHICLES FROM THE RUINS OF NINEVEH.

“The Assyrian came down like the wolf on the fold,
 And his cohorts were gleaming in purple and gold ;
 And the sheen of their spears was like stars on the sea
 When the blue waves roll nightly on deep Galilee.

And there lay the steed with his nostrils all wide,
 But through it there rolled not the breath of his pride ;

And there lay the rider distorted and pale,
 With the dew on his bosom and the rust on his mail.”

BYRON'S *Destruction of Sennacherib*.



FOR centuries the originals from which our illustrations are copied were buried deep in the ruins of Nineveh.¹ To the recent labors of Botta and Layard the world is indebted for those early treasures of Assyrian art that now enrich the Louvre and the British Museum in a state nearly as perfect as when they came from the sculptor's hand. These bass-reliefs once served as ornaments to the temples and palaces of Nineveh, having been preserved some twenty-five centuries, beneath vast accumulations of rubbish, unknown to generations. The mounds from which they were taken stand on the eastern bank of the Tigris, a few miles southward of the modern town of Mosul. The bass-reliefs are evidently not all of

¹ We read in the sacred pages that Nimrod was “a mighty hunter before the Lord. And the beginning of his kingdom was Babel and Erech, and Acad and Calneh, in the land of Shinar. Out of that land went forth Asshur [one of the sons of Noah] and builded Nineveh.” The same authority calls Assyria the land of Nimrod. Usher tells us that Assyria was founded fifteen hundred years earlier than the Egyptian kingdom,

the same date and workmanship, nor from the same edifice, but likely the productions of various periods of Assyrian art.

There is no definite data from which to fix the time when chariots were first introduced into Assyria. There is, however, little doubt of its having been done at a very early period in its history, possibly by the army of Sesostris,¹ who, we are told in the fragmentary history by Manetho, after having appointed his brother Armais viceroy over his kingdom, "went on an expedition against Cyprus and Phœnicia, and waged war with the Assyrians and Medes, all of whom he subdued, either by force, or voluntary submission by the mere terror of his power."² At that time the Assyrian empire had been founded a little more than three hundred years, and although the people were in most occupations behind the Egyptians, still, during the succeeding fifteen hundred years, greater progress was made in the art of chariot-building in Assyria than in Egypt, judging from the figures on the bass-reliefs. The Assyrian chariots exhibit a solidity which must have admirably fitted them for warlike purposes.

The following engraving represents the king of Assyria as in the act of crossing a stream while standing in a chariot, mounted on a boat, attended by a body-guard of eunuchs, one of whom is directing the king's attention to an enemy in the distance. The king, by holding two arrows in his hand, confesses that he is ready for action.

which last it is admitted was the first ever organized. Ctesius (quoted by Diodorus Siculus) says Nineveh was founded by Ninus B. C. 2183. Africanus (quoted by Syncellus) says the Assyrian monarchy was established B. C. 2264; Eusebius, B. C. 2116; Emelius Susa (quoted by Velleius Paterculus), B. C. 2145; Polyhistor (in an extract from Berossus), B. C. 2317. It is agreed by nearly all historians that the empire did not continue longer than thirteen hundred years, ending with the overthrow of Sardanapalus, who died about 743 B. C. Going back thirteen hundred years, we find that Ninus reigned two hundred years after Nimrod, in exact conformity with the chronology of Berossus. Some writers think that Babylonia and Assyria were originally two distinct kingdoms, and that Ninus founded that of Assyria, making Asshur the founder of the *monarchy*, and Ninus the founder of the *empire*. As we have seen, the monarchy ended with the death of Sardanapalus; but during his reign, Arbaces, king of Media, having led his army across the mountains of Kurdistan, after conquering the people, made himself king of Assyria *circa* 804 B. C. After the death of Arbaces, the Assyrians shook off this foreign yoke, and set Pul, the first of a new line of kings, on the throne, he reigning twenty-one years. Tiglath Pileser succeeded him, B. C. 753; after him came Shalmanaser, B. C. 734, followed by Sennacherib, some events of whose history will be noticed in connection with the illustrations of his chariot found in this chapter.

¹ Some incidents in the life of this monarch are given on page 39 *et seq.*

² Josephus, *Contra Apionem*, B. I, ch. 14, 15.

The chariot here represented exhibits the manner in which the Assyrians attached the pole to the body, as well as the shape of the

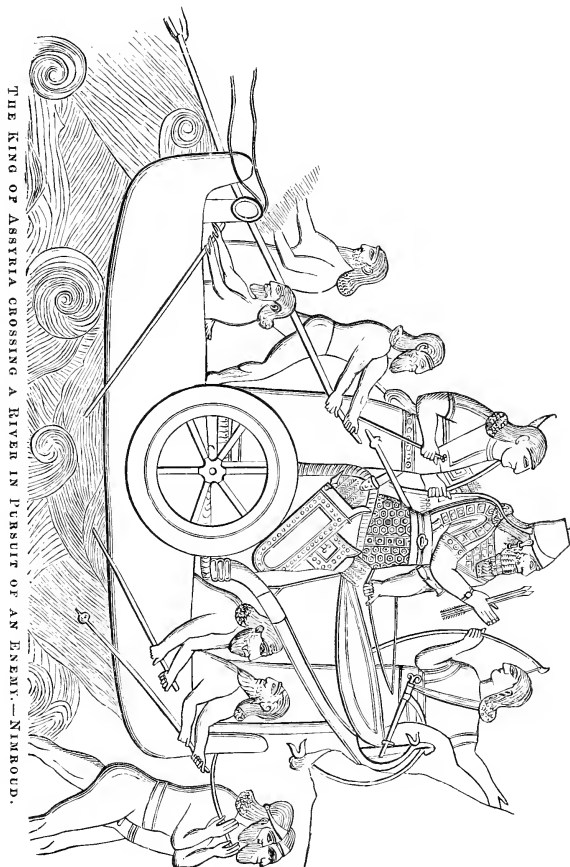

same. The boat itself, propelled by several oarsmen, is further aided by two stalwart soldiers pulling at a rope, while under the pilotage of a helmsman, who for a rudder uses a long paddle. At the left, on

the slab from which our design is copied, four horses are represented as swimming, led by a rope in the hands of the man standing up in the stern, while above a man is seen in the water buoyed up by some kind of an inflated life-preserver, made from what appears to have been raw hide. Following these, in a nude condition, are several soldiers, all mixed up with boats, horses, etc., intended to represent an immense army fording the river against the king's enemy. The body of this chariot differs but little from other examples found in the Nimroud bass-reliefs from Nineveh,¹ as will presently be shown, the object in this instance being to fairly represent the manner of constructing the pole and the arrangement of the furniture, which in most cases hereafter will be hidden by the horses. The pole, bound near the base with three rings, is very graceful in form, and made quite ornamental by the addition of a carved horse-head finish at the extreme end, at which dangles a yoke. The king, besides having his two quivers well supplied with arrows, has resolution depicted in his countenance, indicative of a preparation for any attack the enemy may choose to offer. It is a noticeable feature in this picture that all except "His Majesty," out of respect to royalty, have their heads uncovered.

In trying to fix the chronology of Assyrian art as shown in these pages we have expended much labor with an unsatisfactory result. Our judgment, however, differs in many particulars from that of other historians whose opinions are entitled to respect. For instance, Layard claims that the bass-reliefs from Khorsabad are much older than those from Nimroud. We think otherwise, and arrange them as follows: Nimroud, Khorsabad, and Kouyunjik. This order seems to be justified by the fact that in *all*, or nearly all, the Nimroud wheels there are but six spokes, the same as we have observed in the Egyptian, while in those from Khorsabad there are eight, and in some of those from Kouyunjik there are even more. Again, in the Nimroud sculptures, of which we give a specimen, there is an appendage

¹ Nineveh must have been crowded with chariots, as "the noise of a whip, and the noise of the rattling of the wheels, and of the prancing horses, and of the jumping chariots," are noticed in the Bible (Nahum, ch. iii, v. 2). The city itself was fourteen miles in length, eight in width, and forty in circumference, surrounded by a wall one hundred feet high, and thick enough for three chariots to stand abreast on the summit.

extending from the front of the body to the front of the pole between the horses, the use of which it is difficult to decide, while in those from Khorsabad and Kouyunjik it is entirely omitted. This we suppose in time was considered too cumbersome for practical use, and was therefore abolished. There are other reasons we could mention did we deem it necessary.¹

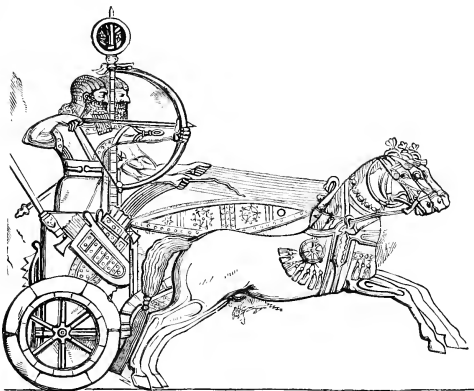

ASSYRIAN WAR-CHARIOT.—NIMROUD.

Before going further, we would remark that the general design and execution of the original bass-reliefs, from which nearly all our examples are copied, evince an advanced degree of refinement that challenges our admiration. The chief object for which they were executed doubtless was to record the more remarkable events in the history of the nation when book-making was less often resorted to than now; and in order to make the picture-record strike the mind of the beholder with more force through the eye, a conventional mode of representation was adopted, never afterwards wholly abandoned.

A very popular author, in comparing Assyrian with Egyptian art, tells us that "the Egyptians, like all other people in their infancy,

¹ We are aware that Bonomi, with considerable ingenuity, endeavors to prove that which we are inclined to dispute, by telling us that "another innovation apparent at Nimroud is the alteration of the chariot, probably copied from some other country. We learn from Xenophon (*Cyropædia*, B. VI) that Cyrus built chariots of a new form, having found great inconvenience in the old ones, the fashion of which came from Troy, and had continued in use until that time throughout all Asia; and we may very easily surmise that the walls at Nimroud supply examples of the Trojan, the intermediate stage between those portrayed at Khorsabad and those introduced by Cyrus."—BONOMI'S *Nineveh and its Palaces*, page 305. The chariots of the Assyrian kings correspond with those of Cyrus, as mentioned by Xenophon and described by Quintus Curtius, B. III, ch. 3. See Layard's *Nineveh and its Remains*, Vol. II, p. 280.

attached importance to the exterior line only. In their paintings and sculptures they made strokes of astonishing boldness and character, by which both proportion and action were rendered with great perfection. But here their science stopped; and in later times, as in the most remote, they never thought of completing these outlines by an exact representation of the anatomical details contained within them. Their finest statues are in this respect as defective as their bass-reliefs and paintings. Seizing on the characteristic forms of their objects, they never varied them under whatever aspect; thus the front view of the eye was always introduced in the profile face, the profile foot in the front view of the figure, and but extremely rarely does the front face occur, although the body may be facing, — a law which seems to have considerably influenced the Greek sculptors in their compositions for *basso-relievo*, and, as it appears to us, one imposed by the art itself. All the necessary details, however, for characterizing the objects in Egyptian and Assyrian *relievi* are always made visible, whether they could in this particular view be seen or not. Lastly, always sacrificing truth to the desire of hiding nothing which in their eyes appeared the more important, the Egyptian painters and sculptors have carefully avoided crossing the figures by accessory objects which would have hidden any part of them, — a law which the Greeks also observed; and possibly to the same law may be attributed, in these and the Egyptian representations of battles, the larger dimensions they have given to the conquerors than the conquered.

“Most of these characteristics are found in Assyrian as well as Egyptian art, but they are less strongly marked, and the careful observer can perceive that the art is emerging from its state of infancy. The bodies are no longer all full-face, if we may so express it, and have less conventional stiffness. The figures consist no more of mere outlines, the heads are well modeled, and the anatomical details of the limbs, the bones, and the muscles are always represented, though coarsely and ignorantly expressed, and with a conventional exaggeration indicating a greater knowledge of anatomy, but a less artistic mode of conveying their knowledge than is found in Egyptian figures of the same age. The reader need only compare some Egyptian figures in the British Museum with some of the Assyrian bass-reliefs in the same establishment to convince himself how superior the latter are as representations of real life; but on the other hand, they are

decidedly inferior in justness of proportion and purity of drawing. In the Assyrian bass-reliefs the figures are generally too short, and the artist has not always succeeded in endowing them distinctly enough with animation."¹ Thus much we have given to prepare the reader for studying the objects which follow, reserving our own observations until we have subjects before us for practical examination.

The full-page illustration which follows would appear to be the representation of a treaty of peace between one of the kings of Assyria² and an enemy. The king, having routed and put to flight his enemies, as indicated by the fillet attached to a spear at the rear of his chariot, has alighted to receive the submission of the *melek*, or representative of the enemy, who probably is likewise himself a king, as, like the conqueror, he is attired in an embroidered tunic, while prostrate at his feet lies a soldier from the conquered army, divested of his armor in token of humility. From the shape of his helmet it is conjectured that this fallen soldier is a rebel Assyrian from a revolted province. Both negotiators are on foot, but the conqueror, attended by two armed eunuchs, one holding an umbrella over his head, holds in one hand a bow ready strung for use, and in the other, upraised, two arrows, showing that, although peacefully inclined, he is prepared for war, if forced to such an alternative. The posture and countenance of the petitioner clearly indicate that he is earnest in his pleadings for mercy. The right hand, unnaturally large in proportion with the other limbs, may signify that his transgressions have been great, and that consequently he craves a *large* forgiveness. The victorious monarch is followed by his chariot and attendants in Oriental style, the charioteer holding the reins, guarded by a soldier, the horses being held by a groom. Proceeding from the front of this chariot is the very richly embroidered appendage previously referred to on page 73, probably intended for two purposes, the one ornamental, and the other as a preventative against the coming together of the horses. The shape of this chariot is similar to that on page 71. The spear, stuck in its appointed place, in a socket behind, is ornamented with a carving representing a human head. At the rear of the chariot hangs the embossed shield of a warrior, its accustomed place when not in

¹ Bonomi's *Nineveh and its Palaces*, pp. 313, 314.

² Probably Asshur-izir-pal.

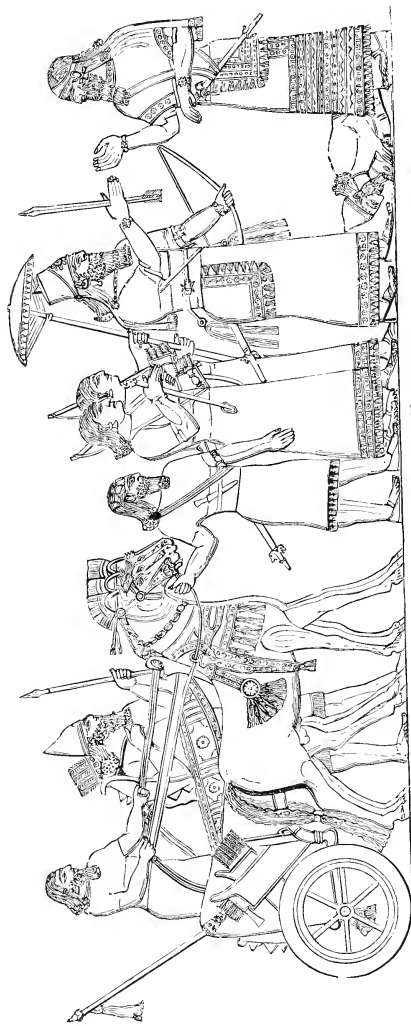

ASSYRIAN TREATY OF PEACE.—NIMROUD.

use, while beneath the axle-tree depend two heavy tassels, serving as ornaments, matching those in the harness. An ample supply of arrows projecting above the quivers, accompanied by a battle-ax, indicates the undiminished powers of the victorious chief on this occasion.

A bass-relief representing an Assyrian lion-hunt in the wilds of Ethiopia was discovered by Layard in 1866, among the ruins of a temple at Nineveh. In the chariot represented on the slab stands the king with his charioteer, the monarch in the act of discharging an arrow, drawn by three horses, as that number of heads show, their trappings being much more elaborate than the Egyptian. In this case we find, instead of plumes, large tassels falling on the foreheads of the horses between the eyes, probably considered more appropriate in hunting wild animals than the business of warring upon mankind. The bridle usually consisted of head-stall and strap, in three divisions, connected with a bit, with others over the forehead, under the cheeks, and behind the ears, and a very large rosette, an ornamental appendage hanging from the saddle just back of the fore shoulders and over them. There is likewise a fanciful compression of the tails of the horses in the center, differing from the Egyptian. The chariot, in the example alluded to, has a plain panel in the side and a highly ornamented pole, strengthened in the crooked portion by three rings, supported in its place by a brace, probably iron, depending from the upper portion of the body. The body itself is much lower at the back end than it is in front, the back having a singular fixture attached, the use of which is unknown.

Hunting the king of beasts was anciently, as now, evidently considered a dangerous business, for we see in this picture that the huntsman has crowded his quiver full of arrows, and provided himself with a sword, two daggers, and also two hatchets, besides filling his hands with an extra supply of arrows and a long spear. The body is hung in front of the axle-tree, which is additional evidence of its antiquity. A lion struggling beneath the feet of the horses, pierced by the hunter's arrow, is singularly expressive, in the countenance, of agony in death.

In a second example, furnished by Layard, is shown another lion-hunt, where the hunter is attacked from the rear of a chariot by the infuriated beast, already wounded, and the charioteer is seen



ASSYRIAN LION HUNTER. — NIMROUD.

urging on his steeds at a furious rate in order to escape threatened danger, the lion having planted his fore-paws upon the back end. The king having turned himself about at this critical moment, discharges an arrow at the head of the monarch of the forest, who, by the position of his tail, shows that he is furious with rage. Just behind the chariot stand two attendants with shields and daggers, ready to lend their assistance to the sovereign, or to defend themselves should occasion require. Under the feet of the horses lies another lion in the agonies of death.

The lion attacking the sportive king has a singular looking "fixture" in the end of the tail. Bonomi tells us that "the existence of a claw in the tuft at the end of the lion's tail was disputed for ages," but here in these ancient bass-reliefs is an exaggerated representation of it, in support of a curious fact in natural history. This peculiarity was first recorded by Didymus of Alexandria,

an early commentator on the Iliad, who flourished about forty years before the Christian era. Homer and other poets feign that the lion lashes his sides, and Lucan states that he does so to stimulate himself

to rage; but not one of these writers adverts to the claw in the tail, although Didymus, who lived one hundred years before the last-named author, discovered it, and conjectured that its purpose was to effect more readily what Lucan ascribes to the tail alone. Whatever may have been the supposed use or intention of this claw, its existence has been placed beyond all dispute by Mr. Bennett, who, at one of the meetings of the Zoölogical Society of London in 1832, showed a specimen of it, which was taken from a living animal in the Society's Menagerie.¹ It is no small gratification to be able now to quote, in evidence of the statement of Mr. Bennett and his predecessor, Didymus of Alexandria, this original and authentic document, on the authority of the veritable descendants of the renowned hunter himself,—a document, too, that any one may read who will take the pains to examine the slab under consideration.²

The next illustration is copied from Botta's great work, the original of which was discovered by him among the ruins of Khorsabad. Although somewhat defaced by the action of time, yet as representing a chariot it is the most perfect in his collection. This is very evidently a war-chariot, drawn by three horses, as the head-plumes indicate, although, as usual in Assyrian drawings, they are deficient in the requisite number of heads and legs, in which stand three warriors, the king with his bow strung, the charioteer, and the guard holding the shield in his hand as a defense. In front of the horses falls a soldier from the ranks of the enemy, who, being wounded, drops his spear; while behind the chariot march two others, from the looks of their sheepskin dress apparently his comrades in misfortune, one of whom holds in one hand a spear, and in the other a shield. The original slab (Botta, No. 65) forms a portion of the picture taken from the private council-chamber in the palace of Khorsabad, probably intended to perpetuate the more important events in the history of some king. The chariot is square, the ornamental adornings being more elaborate than in any example heretofore given. In front of the chariot there is only a single brace extending to the end of the pole, instead of the cumbersome fixtures in other examples from Nimroud. It is note-

¹ See the *Proceedings of the Council of the Zoölogical Society of London*, 1832, p. 146. This singular instrument in the tail of the lion, we suspect, is a rarity, as such have not been discovered in the lions brought to this country, that we have ever heard of.

² Bonomi's *Nineveh and its Palaces*, p. 246.

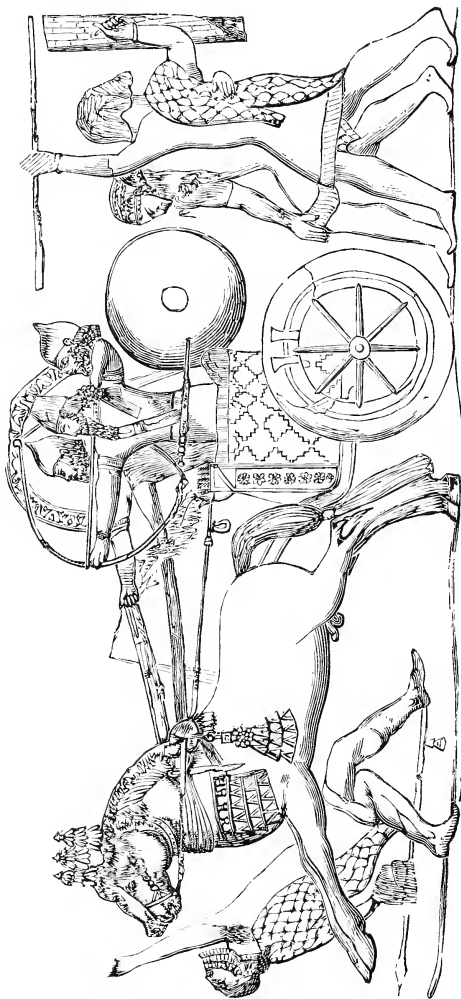

ASSYRIAN WARRIORS IN BATTLE.—KHORSABAD.

worthy that in Assyrian war-chariots the quiver is placed in an upright position at the front end, instead of the slanting one we have seen them occupy in the Egyptian examples.¹

The trappings and harness of the horses at this period differ in many respects from those we have previously given from Ninroud. Three elegant plumes wave over the heads of the horses, arched crests and tassels spreading across the forehead and falling nearly to the eyes, and the harness attached to the yoke is more profusely ornamented with rosettes and fringes in a much more plain and simple manner. In the earlier figures the tails of the horses are simply bound in the center with ribbons, but as we proceed we find that those represented on the bass-reliefs at Kouyunjik are sometimes plaited, as in the Persian sculptures and on the earlier tombs of Xanthus.

Another chariot of about the time we write is elegant in proportions and elaborately painted. The harness is much like the pattern given

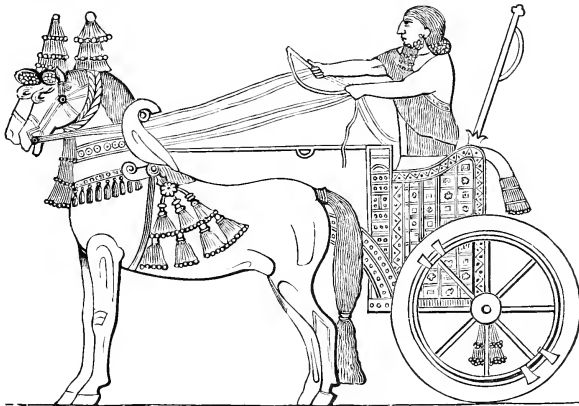

EUNUCH WITH HORSES.

in our last figure, but better displayed in the drawing. The bodies of these last show a marked progress in art, being much more graceful in design, although little progress appears in the hanging-off. The

¹ See "Monument de Ninive Découvert et Dégrié, par M. P. E. Botta, mesuré et dessiné par M. E. Flandrin, ouvrage publié par ordre du gouvernement sous les auspices de M. le Ministre de l'Intérieur et sous la direction d'une commission de l'Institut. Paris: Imprimerie Nationale. 1850."

pole, as before remarked, no longer terminates in a fanciful head of some animal, if we may form an opinion from inspecting the bass-reliefs, but instead is more highly ornamented at the base. The wheels, too, were much higher, being some five feet. The upper portion of the body, instead of being rounded, was nearly square. It is probable that many of these chariots were inlaid with gold, silver, and costly woods, and also painted like some of the examples taken by the Egyptians in Mesopotamia fifteen centuries before the birth of Christ, as recorded on a statistical tablet at Karnak, which mentions "thirty chariots worked in gold and silver and painted poles," brought as trophies from that country.¹ From a passage in Zechariah it would seem that among the ancients it was usual to pair horses according to their color, — a practice followed by us in our times.²

There is one very remarkable feature in some of the wheels of these Assyrian chariots that distinguishes them from the Egyptian. If we examine the bass-reliefs we find that the spokes especially are very light in comparison with other portions of the wheel, — a circumstance favoring the probability that they were made of iron. This surmise is somewhat strengthened by the fact that the fragment of a small circle, undoubtedly forming a portion of a car-wheel, has been found in the ruins of Nineveh, on the concave side of which still remain the iron roots of the spokes. The rims of these wheels appear to be composed of two concentric circles, the external one being united to the other by broad flaps or plates in most examples, although not shown in all.

¹ The chariots and horses of Naharaina (Mesopotamia) are mentioned on an Egyptian monument of the eighteenth dynasty. "An officer of Thothmes I captured for him, in the land of Naharaina, twenty-one hands [eleven men], a horse and chariot." — BURCH'S *Memoir on the Statistical Tablet of Karnak*, p. 8. Chariot cities, or cities for the support of warriors fighting in chariots, are frequently mentioned in the Bible, as in 2 Chron., ch. i, v. 14, and ch. viii, v. 6. According to the Mosaic law, David could not possess chariots nor put his trust in them; yet when the Ammonites and Syrians, after their disgraceful conduct towards his pacific messengers, had come out in battle against him with thirty-two thousand chariots hired out of Mesopotamia, he slew, according to the sacred historian, seven thousand men "which fought in chariots," showing that such were numerous in that day.

² "And, behold, there came four chariots out from between two mountains; and the mountains were mountains of brass. In the first chariot were red horses, and in the second chariot black horses, and in the third chariot white horses, and in the fourth chariot grizzled and bay horses." — *Zech.*, ch. vi, v. 1-3.

Special pains for the accommodation of royalty were taken among the Assyrians. On one bass-relief we observe two eunuchs carrying a sort of arm-chair on their shoulders, elegant in design, supplied with wheels to be drawn by hand should the king have occasion to visit mountainous regions inaccessible for chariots. This was constructed as follows: the seat, after the chair model, was straight in the back, having arms or resters bent after a peculiar pattern to join an interior square leg. At the side are three bearded figures, having a tiara on the head of each ornamented with bull's horns doubled. Between the seat and a sort of round, connecting the front and back legs, is an elegant miniature figure of a horse in harness, which seems to push forward with his chest the leg before him. The bar supporting this equestrian ornament is studded with *fleur-de-lis* placed base to base, thus completing the

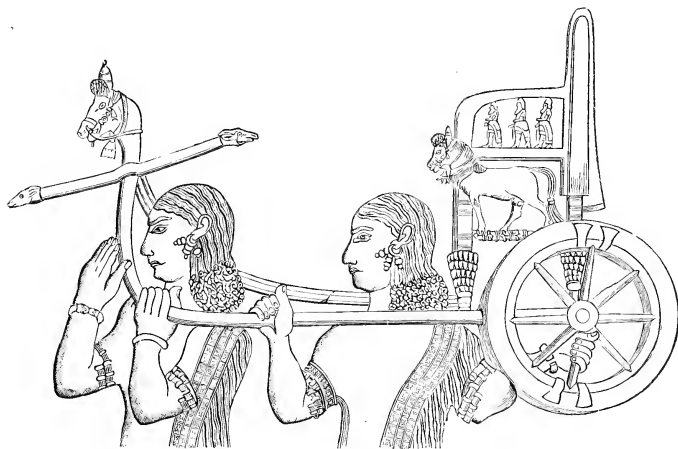

THE KING'S CHAIR BORNE BY EUNUCHS.—KHORSABAD.

connection, the legs terminating in a conical mass formed of rows of scales, like those of a fir-cone, lessening in size as they near the point. The chair is placed with two legs on the axle-tree, the other two being inserted in the shafts. The wheels, heavy in the felloes, like all Assyrian chariots, are studded with eight spokes. The shafts are straight at the base and curving in front, terminating in a curved

horse-head. The yoke or draw-bar has a sheep's-head finish at both ends.¹

Another party—two soldiers—are represented (Botta, Pl. XX) as carrying on their shoulders the chariot represented in our engraving. It is supposed to have been taken from some contemporary nation among the spoils of a captured city, as the chariot differs altogether from the Assyrian. The wheels, although massive in the felloes, have only four spokes in each hub. The body and pole are decidedly

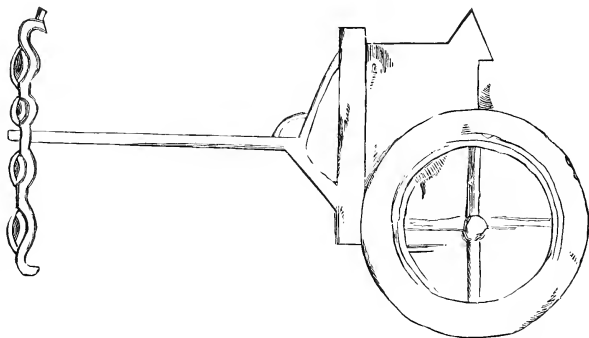

CHARIOT CAPTURED BY THE ASSYRIANS.—KHORSABAD.

unique, this last being attached to the body in the most unmechanical manner possible. Unless well plated with iron, it must have proved a very weak affair. The yoke is likewise very curious, the whole thing representing a very inferior work of art when compared with the chariots of Assyria.

Kouyunjik Tepè, as the place is called by modern Arabians, lies northward of Ninionah, and consists of a mound probably formed out of the ruins of a temple or palace erected by some Assyrian monarch, possibly by Sennacherib, since the bass-reliefs exhumed by Layard chiefly relate to some events in his remarkable life. This palace is much more modern than either Nimroud or even Khorsabad, as the relics found in its ruins fully demonstrate. In the chariots, both in construction and design, great improvement has been made, as will hereafter appear.

¹ The original is on exhibition in the Louvre, numbered 25, beautifully executed.

The illustration on next page represents the chariot of Sennacherib, — proved such by the cuneiform inscription which accompanies the original slab, — the great king of Assyria, who “came up against the fenced cities of Judah and took them,” during the reign of King Hezekiah.¹ The king, having left his chariot in the charge of attendants, is depicted as sitting in judgment on a marble throne before the city of Lachish, an officer of rank standing in his presence, probably Rabshaketh himself, followed by a detachment of soldiers. A little way off captive Jews are seen. Near by, the king’s chariot, shown in our engraving, stands ready for use at his call. The charioteer, as well as his umbrella-bearer and hostlers, are at their posts, making the safety of the chariot and horses doubly sure. The most noticeable feature in the construction of this chariot is the unusually high wheel and the exquisite finish given to the whole. The body of the chariot differs in design from anything which has hitherto met our notice. On a line with the front and upright stands the empty quiver; and slung at the side, at an angle of forty-five degrees, hangs an ornament reversed, similar to the one seen between the horses in the chariots from Nimroud previously given. For what use these were originally intended is not clear, probably more as an ornament than for any practical purpose.² The two horses have head-gear differing from previous exam-

¹ B. C. 720. For an account of this expedition, see 2 Kings, ch. xviii. The following is the Assyrian’s story as detailed on the slab: “Because Hezekiah, king of Judea, did not submit to my yoke, forty-six of his strong-fenced cities and innumerable smaller towns which depended on them I took and plundered; but I left to him Jerusalem, his capital city, and some of the interior towns around it. . . . And because Hezekiah still continued to refuse to pay me homage, I attacked and carried off the whole population, fixed and nomadic, which dwelled around Jerusalem, with thirty talents of gold and eight hundred talents of silver, the accumulated wealth of the nobles of Hezekiah’s court and of their daughters, with the officers of his palace, men-slaves and women-slaves, I returned to Nineveh, and I accounted their spoil for the tribute which he refused to pay me.” Even the will of this monarch, in baked brick, is shown in the British Museum. The following is Mr. Smith’s translation: “I, Sennacherib, king of multitudes, king of Assyria, have given chains of gold, heaps of ivory, a cup of gold, crowns and chains, with them, all the wealth that [I have] in heaps, crystal, and another precious stone, and bird’s stone; one and a half maneh, two and a half *cibi* in weight, to Esar-haddon my son, who was afterward named Assur-ebil-mucinpal according to my wish. The treasure [is deposited] in the temple Anuk and [Nebo] irik-erba, harpists of Nebo.” This is probably the oldest will extant, and consequently of much interest.

² Some writers conjecture that it was designed to separate the horses. Was not the pole sufficient for *that* purpose?

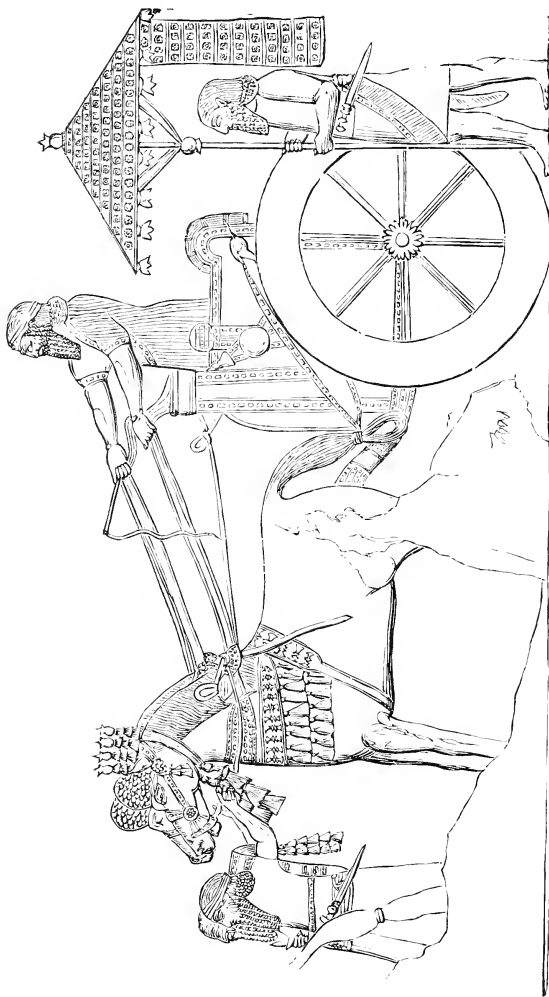

THE CHARIOT AND CHARIOTEER OF SENNACHERIB IN WAITING BEFORE LACHISH.—KOUYUNJIK.

ples, and the harness and trappings are of superior finish. The tails of the horses, too, are tied in a knot unlike those from Nimroud and Khorsabad, but which fashion will be seen again in the bass-reliefs and sculptures from Persepolis.

Passing by other objects in Layard's work,¹ many of them deeply interesting, we come to a plate numbered XLII (see next page), and find "the great king" Sennacherib represented once more as standing in his chariot before a besieged city, possibly Lachish, accompanied by his charioteer, and eunuch umbrella-bearer, holding one of peculiar make over his royal head. The chariot, attended by soldiers, differs but little in outline from the one represented on the previous page, but is richer in finish. The artist evidently forgot to put a pole in this vehicle, a matter of some regret. The harness in this instance is much plainer than the last, and there is an ornament rising from the saddle after an entirely new pattern. The inscription, in Assyrian characters, gives the history of the visit of Sennacherib to Judea, as previously related in a note.

Although in many respects the Assyrian and Egyptian harness and trappings resemble each other, still in some points they differ. Pendant at the sides of the horses we find a circular ornament terminating in tassels analogous to that divided into thongs in the Egyptian, which some suppose were intended to accelerate the pace of the animal, as in the case of the spiked balls fastened to the trappings of race-horses on the Corso in modern Rome. In both examples, several bands pass over the chest, and, lapping over the shoulders of the horse, join the ligaments attached to the yoke or pole. A remarkable band or thong, through the upper end of which passes a single rein, is the same in both. The tails of the Assyrian horses, on the bass-reliefs from Nimroud and Khorsabad, are fancifully compressed in the center, while the Egyptian have a band round the upper part or root of the tail. Around the necks of the Assyrian horses, as in the last example, is a string of alternately large and small beads, which appear to have cuneiform characters cut upon them, — possibly a series of amulets or charms, according to the custom of many Oriental nations of the present day. The head-dress of the horses differs from the Egyptian,

¹ The curious reader who would study the history of Sennacherib further, will be interested in Layard's series of plates, from XX to XXIV inclusive.

Some have surmised that the walls of Nimroud furnish us with examples of the Trojan chariot, the intermediate stage between those portrayed at Khorsabad and Kouyunjik and those introduced by Cyrus.¹ It is evident from the testimony of ancient writers that Troy was in close alliance with the Assyrians at one period of her history. Plato says that "when Teutamus—who was the twentieth from Ninus, the son of Semiramis—reigned in Asia, the Grecians, under their general, Agamemnon, made war upon the Trojans, at which time the Assyrians had been lords of Asia above a thousand years. For Priam, the king of Troy (being a prince under the Assyrian empire when war was made upon him), sent ambassadors to crave aid of Teutamus, who sent him ten thousand Ethiopians, and as many out of the province of Susiana, with two hundred chariots under the conduct of Memnon, the son of Tithon."²

We have now produced the chief features in Assyrian chariots, as shown on the lately exhumed bass-reliefs, and may with Rawlinson, in his "Ancient Monarchies," very properly inquire, "Was the art of the Assyrians of home growth, or imported from the Egyptians either directly or by way of Phœnicia? The latter view has sometimes been taken; but the most cursory study of the Assyrian remains in chronological order is sufficient to disprove the theory, since it shows that the earliest specimens of Assyrian art are the most un-Egyptian in character.³ No doubt there are certain analogies even here, as the preference for the profile (although, as we have seen, this is no longer given in outline merely), the stiffness and formality, the ignorance and disregard of perspective, and the like; but the analogies are such as would be tolerably sure to occur in the early efforts of any two races not very dissimilar to one another, while the little resemblances which alone prove connection are entirely wanting. These do not appear till

¹ According to our theory this "surmise" cannot be true, as we have considered the sculptures from Nimroud much the oldest of the three. See page 72.

² Plato, *De Legibus*, B. III. Plato further informs us that this Tithon was governor of Persia, and a favorite with the king of Assyria, and that he showed great valor before the walls of Troy, slaying many Grecians, previous to falling into an ambush of Thessalians, who slew him. Troy was taken A. M. 2820, B. C. 1134 years; and the Assyrian monarchy, according to Berosus, ended A. M. 2317. This account is unsupported by subsequent historians.

³ During the eighteenth dynasty Egypt and Assyria were in close connection, as is shown by the relics collected from the ruins of the latter.

we come to monuments which belong to the time of Sargon, when direct connection between Egypt and Assyria seems to have begun, and Egyptian captives are known to have been transported into Mesopotamia in great numbers."

Besides the chariots which we have endeavored to describe, we find several carts, chiefly taken from contemporary nations with whom the Assyrians had waged war, among the relics from Kouyunjik, the originals of which are in the British Museum. These are supposed to

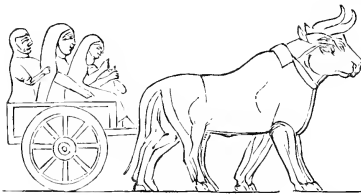

SUPPOSED JEWISH CAPTIVES IN A CART.

represent the vehicles captured by the Assyrians from the Elamites and perhaps some other nations, which as trophies were considered of sufficient importance for a place in these ancient records of the nation's history. The engraving is supposed to represent a cart taken from Armenia or Judea, in which women are carried into captivity. This cart, drawn by a yoke of oxen, has eight spokes in the wheel, the usual number given by Assyrians of this period to chariots. As the palm-tree figures on the slab from which this picture is taken, the inference is that the captives were inhabitants of some part of Babylonia, or possibly of Judea, against which, as we have seen, Sennacherib led an army of invasion. The dress of the captives appears to be that of Jewish women.

Some of the bass-reliefs represent carts drawn by mules. Such is the case in the copy represented here, mounted on which are shown some of the captives of Sennacherib carried off from Susiana. These simple machines were not only used for the transportation of merchandise from one place

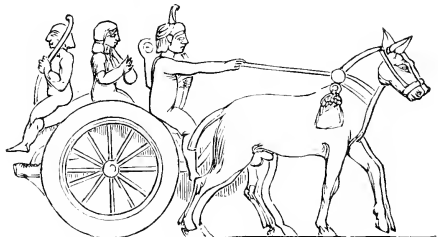

SUPPOSED SUSIANIAN MULE-TEAM.

to another, but, instead of chariots, for warlike purposes, some of them being capable of seating five or six persons, as we see in the Elamitish cart, where the floor is covered with a sort of carpet, set off with fringe.

In the next illustration we find a singular sort of cart, the platform or body of which is mounted on exceedingly high wheels, having likewise in each twelve spokes. This cart is supposed, from the accompanying description, to have been taken from the Elamites. On it we find a number of Assyrian soldiers driving furiously over the battle-field, regardless of the bodies of the wounded and slain with which it is thickly strewn. As usual with the ancients when recounting their warlike deeds, no Assyrians are found to have been killed on this occasion.

On some of the smaller carts represented on the bass-reliefs we find only the driver and a single warrior sitting upon a raised seat or dais. Layard supposes that this description of cart, or "wheels," is alluded to by the prophet Ezekiel,¹ when he speaks of "the chariots, wagons, and wheels" belonging to "the Babylonians, and all the Chaldeans, Pekod, and Shoa, and Koa, and all the Assyrians," who should come up against Abolihah (Jerusalem). The harness of the mules was of the most simple description, having a band around the chest, set off with rosettes, tassels, and a head-stall. Sometimes the guiding of the animal was performed by a rod in the hands of the driver.

Another bass-relief represents a party of captives resting after a



ELAMITISH CART IN THE SERVICE OF ASSYRIAN SOLDIERS.

¹ Ezekiel, ch. xxiii, v. 23, 24, *et seq.*

fatiguing journey, having unharnessed their mules from a loaded cart, and fed them with grain of some kind, which they appear to be eating. Between the mules and the cart a woman is seated on a stone, holding a child. In front of her appears a man, probably her husband, drinking from a cup in the most primitive fashion.

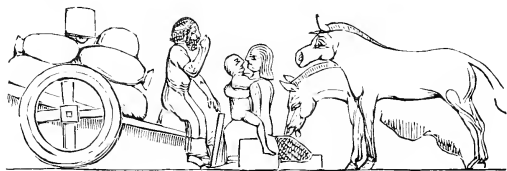

MULE-TEAM AND PARTY AT REST.

A remarkable feature in this engraving is, it has only a four-spoked wheel, the whole being very rude and clumsily made.

The slabs from which all these carts are copied undoubtedly represent the spoils of victory obtained by Sennacherib in some of his expeditions against the nations, as they were found among the ruins of his palace. In the third year of his reign he overran all Syria, subjecting the people to his authority. Afterwards he took Samaria, carrying away the people with him. Ten years later he went up against all the fenced cities of Judah and took them. So greatly did he frighten the good King Hezekiah, that to get rid of the invader he paid "three hundred talents of silver and thirty talents of gold."¹ This victory is supposed to be recorded on the slabs representing our carts; the disastrous expedition afterwards undertaken, from which he returned to be murdered by his sons, not appearing to have been preserved anywhere outside the pages of Holy Writ.

¹ 2 Kings, ch. xviii, v. 14.



PERSIAN CHARIOTS (INCLUDING SCYTHI), THE HARMAMAXA, AND ALEXANDER'S FUNERAL CAR.

“Thus they with vague surmises in crowds discoursed,
 Listening and whispering ; when in burnished car
 Pelius, with mules all panting, thither forced
 His winged speed.”

PINDAR'S *Pithian IV.*

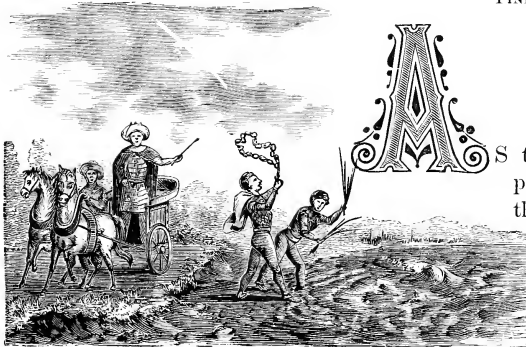

AS the Persian Empire grew out of the ruins of the Assyrian, it is quite natural to suppose that its architecture and other artistic

productions should partake somewhat of the pattern set by that nation. Such, we learn from Herodotus, was the case. If any doubt remained, it would be removed by the character of the few bass-reliefs still extant among the ruins of Persepolis.¹ In Sir Robert Ker Porter's

¹ “Chebel-Minar, or Persepolis, according to the *Dabistan*, a work compiled from ancient Geber fragments, was founded by Jemsheed, the sixth king of Persia, who was contemporary with Zohawk, a tyrant of Assyria, who is supposed to be the Nimrod of Scripture.” — SIR ROBERT KER PORTER'S *Travels in Georgia, Persia, Armenia, Ancient Babylon, etc.*, 2 vols., London, 1821. Other writers ascribe its organization to Darius Hystaspes, he being a Persian (B. C. 521). After the establishment of the empire by Cyrus, his successors divided their residence between Babylon, Susa, and Ecbatana, the principal city of Media, of which he was before that simply king. In the days of its prosperity, Persepolis was one of the wealthiest as well as most august cities of the world. After the battle of Arbela (B. C. 320), when Alexander obtained a signal victory over the Persians, he marched his army into Persepolis, taking it by

account of his travels, there is the representation of a chariot, which he copied from the original, sculptured on a staircase to one of its edifices. An ancient coin found among the ruins of Babylon gives us a similar picture. The portion here represented is thus described

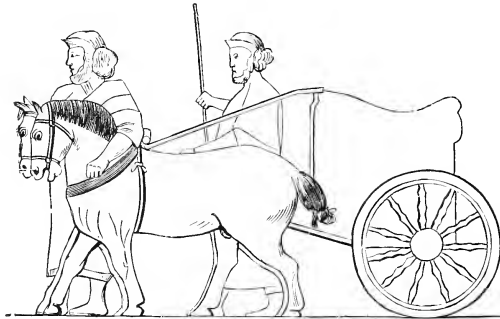

CHARIOT FROM THE RUINS OF PERSEPOLIS.

by our author :
 "The two remaining persons of the group are beside a large chariot, which is drawn by a magnificent pair of horses; one of the men, in ampler garments than his compeer, and

bareheaded, holds the bridles of the horses. His companion in the rear . . . follows, leaning his left hand on the backs of the animals and holding a long wand in the other. The horses are without trappings, but the details of their bits and the manner of reining them are executed with the utmost care. The pole of the car is seen passing behind the horses, projecting from the center of the carriage, which is in a cylindrical shape, elevated rather above the line of the animals' heads. The wheel of the car is extremely light and tastefully put together. In fact, the whole of this chariot group is portrayed and finished with a beauty and accuracy that alike excite our wonder and admiration."

The next illustration, likewise from the ruins of Persepolis, is copied from Niebuhr,¹ who describes it as a *currus*. The chariot in

storm, and putting its inhabitants to death. During his stay there, at the solicitation of a courtesan who had *captivated* him, he burned the greater portion of the city, — an act which in his more sober moments he exceedingly regretted. Persepolis seems never to have recovered from this disaster, but gradually to have fallen, until a final blow was given to it by Sumeanah-a-Doulah, a vizier of the caliph of Bagdad, then master of Persia, in A. D. 982.

¹ Carsten Niebuhr, a native of Hanover, with four other gentlemen, was, in 1761, sent on an expedition into Arabia and India by the Danish government for the advancement of geographical knowledge. All perished except Niebuhr, who alone

this instance is in a better state of preservation than the last. Like the first example in this chapter, the wheels are roughly shod, after the fashion of the Assyrian on page 88. The position of the men, and the manner in which they clasp the horses with their arms, is characteristic and worthy of note, going to prove that most likely they are both the production of the same artist. The chariot is similar to the triumphal chariot of Rome, as will hereafter be seen.

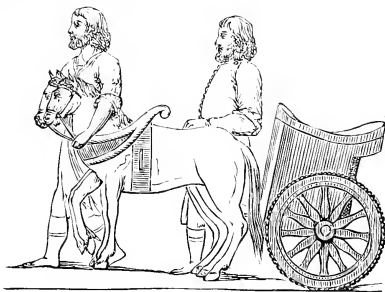

CHARIOT.—FROM NIEBUHR.

The illustration on next page is taken from a bass-relief which unfortunately has only come down to us in a fragmentary state, but which supplies us with a much improved figure of the Persian chariot, and is evidently of a much later date than the above. Of its Persian origin there remains no doubt, the head-dress of the charioteer and the trappings of the horses furnishing sufficient evidence of the fact, but a more perfect original is desirable in order to fully satisfy the mind of an antiquarian. The curve-shaped ornament fixed over the saddle is similar to the one attached to the saddles of Sennacherib's horses in the preceding chapter. It is a noticeable feature in all representations of Persian chariots, that they invariably show only two horses on the bass-reliefs which have come down to us. Modern historians have added more, but with doubtful authority.

The illustration on page 97 is copied from a bass-relief in baked earth from the Lyons collection in France. It formerly belonged to M. Raoul Rochette, keeper of the cabinet of medals, after the death of whom it came into possession of the Duke of Lyons. A writer in the "Magasin Pittoresque" has supposed this to have had an Etruscan origin, and describes it as "representing some incident in mythology which seems to have been a common fund for the artists of Greece and Etruria. Its style, which classes it among the works of a very remote time, and all its details, make it an interesting subject of study.

pursued his journey through the Persian Gulf, Bagdad, Armenia, and Asia Minor, returning home in 1767.

"Two men are seen standing in a chariot; they appear to be warriors, or rather a hero and his esquire or charioteer, as it will be observed that the one wearing a plumed helmet carries a lance and buckler, while the other is only covered with defensive armor, and seems to be solely occupied in guiding the horses which draw the



ANOTHER CHARIOT FROM THE RUINS OF PERSEPOLIS.

chariot. By the position of the arm it is evident that he is about to turn the team to the right. Both men have their eyes fixed on a bird, doubtless of good omen, while it is flying before them. It is known that the ancients drew omens from the flight of birds; that the apparition of certain kinds of birds at the commencement of an expedition, or in any other circumstance of doubtful issue, was invoked, and interpreted, according to the direction of their flight, as a sign of the celestial will. The

eagle, the falcon, and other birds of prey were particularly considered the messenger of some divinity. The bird which wings its flight over

the chariot, as if descending from heaven, appears to be of this kind. A similar bird is represented on the buckler of the principal warrior; it is the emblem by which he may be recognized when he advances with the lowered visor in the midst of the battle. We have, therefore, an additional motive for believing that the presence of the bird which is flying before him is not an indifferent circumstance. In Greek and Etruscan painted vases, birds are thus frequently represented accompanying warriors and chariots. It is, unfortunately, difficult to say precisely to what species the bird before us belongs; if we knew, we could perhaps know also who the warrior is who has taken it for his



SUPPOSED PERSIAN CHARIOT FROM THE LYONS COLLECTION.

distinctive insignia, and know to a certainty what scene of the heroic mythology is here represented.

"The details of the team, the harness, and the chariot are interesting to observe. The body of the chariot seems to be made of a light wood, as of interlaced canes. Similar chariots are seen in the Assyrian bass-reliefs, and others, somewhat resembling this, on Etruscan and Grecian painted vases. A chariot thus constituted must have been of extreme rapidity and of scarcely any weight. Such was, no doubt, under the sheets of gold and silver which covered it, the chariot which Diomedes took as spoil from Rhesus after having killed him; in fact, he deliberated with himself, says the poet, as to

whether he would take it off of its wheels and carry it away on his shoulders."¹

The French editor has evidently mistaken his subject. It is well known that the Persians were strenuous believers in auguries² and omens, as appears from the works of Xenophon. This chariot is probably, like the other, a Persian relic of a still later time. Its general character leads to such a conclusion.

The next illustration, also from the ruins of Persepolis, is selected from a number of representations of different deities typical of the

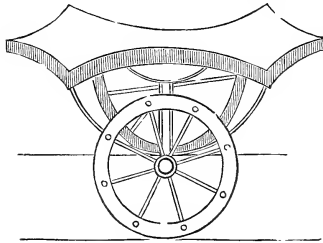

seasons. This small wheel-carriage served as a sort of moving platform for one of their idols,³ who was seated upon it in Oriental style. The mode of attaching the axle to the carriage differs from that of the Greek and Roman cars of a contemporaneous period, or, indeed, from any other we have seen in antique sculpture or elsewhere.⁴

Having disposed of the chariots after the old model, which Xenophon says came from Troy,⁵ we come now to consider those with scythes, said to have been invented by Cyrus, although such are reported to have been employed in the army of Ninus, one of the earlier kings of Assyria.⁶

About the time of his contemplated expedition against Sardis, a

¹ See Homer's *Iliad*, B. X, 503-505.

² Augury, which in the Greek language originally signified a bird, was by metaphor taken to signify that discovery of futurity to which birds were supposed instrumental.

³ Xenophon says (*Cyropædia*, B. LVII, ch. 3) that Cyrus, in sacrificing to the gods, among other things offered "a white chariot, with its perch of gold, adorned with a crown or wreath around it, and sacred to Jove. After this a white chariot, sacred to the sun, adorned with a crown as that before. After this proceeded a third chariot, with its horses adorned with scarlet coverings," etc. Q. Curtius (B. LII, ch. 3) also refers to this sacrifice. Layard (*Nineveh*, p. 151) mentions two chariots dedicated to sacred purposes in the sculptures of Khorsabad.

⁴ *English Pleasure Carriages*, by Wm. B. Adams, London, 1837, p. 24.

⁵ Xenophon's *Institution of Cyrus*, B. VI. Cyrus was born A. C. 599.

⁶ Ctesias, a much older writer than Xenophon, says that Ninus, the son of Nimrod, who is supposed to have founded Nineveh, in his expedition against the Bactrians, had an army that "consisted of seventeen hundred thousand foot, two hundred thousand horse, and about sixteen thousand chariots armed with scythes."

dependency of the Assyrian empire, Cyrus conceived the idea of constructing something which he thought would prove more effective in battle than the old-fashioned chariots. With this object in view, new chariots were built out of such material as he could lay his hands upon, and the old ones captured from his enemies in previous contests were repaired, and all fitted out with scythes according to his instructions. Xenophon, who writes from personal knowledge, says that Cyrus had such a low estimate of the chariots before in use among the Cyrenians, Medes, Arabians, Syrians, and other Asiatic nations, that he utterly abolished them. He entertained the opinion that formerly the very best of the men, those which probably constituted the chief strength of the army, mounted in the chariots, had, in fact, only acted the part of skirmishers at a distance, and had contributed but very little towards the obtaining of a victory. He argued that three hundred chariots would require three hundred combatants, requiring twelve hundred horses, demanding a driver for each chariot, whose skill was entirely lost in guiding the chariot, without contributing in the least to a victory.

The chariots invented by Cyrus are said to have been provided with wheels of great strength, so as not to be easily broken, and with axle-trees that were very

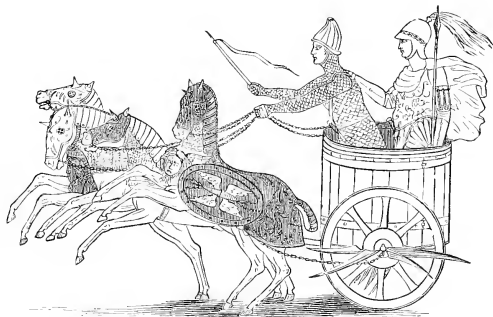

PERSIAN SCYTHE-CHARIOT.¹

long, because, if the track was very broad, they would not so easily be overturned. The box for the driver he had made like a turret,

¹ The engraving, copied from Ginzrot's *Wagen und Fahrwerke*, is supposed to represent a chariot of about the description given us in the notes of Xenophon. Although the ordinary scythe-chariot was only mounted by one man, or driver, there were on those of the leaders, besides the leader himself, a driver and sometimes another combatant. The horses here, four in number, are maled, but it requires little reflection to see that two were better than more in battle.

with strong pieces of timber; and the highest of these boxes reached up to the elbows of the drivers, that, reaching over these boxes, they could drive the horses. These drivers were covered, all but their eyes, with armor. To the axle-trees at the ends he attached steel scythes about two feet and a half long, and below, under the axle-trees, he fixed others, pointing to the ground, intending with these chariots to break in on the enemy.

Abradatus, king of the Susians, who had revolted from the Assyrian government and joined his fortunes with those of Cyrus, observing his leader engaged in his newly invented chariots, followed suit with one hundred for his own service, mounted on one of which he intended to lead the van. This intended for his own personal use he framed with four perches, to which he harnessed eight horses, in this instance distancing our three-perch contemporaries several centuries. Panthea, his wife, having provided him with a golden corselet, head and arm pieces, and his horses with brass defenses, no doubt he considered himself invulnerable, although, as the sequel proved, a fall from his chariot ended in death.

Seeing Abradatus' four-perch chariot, Cyrus considered that it might be advantageous to make one with eight, so as to draw the lower frame of his machine with eight yoke of oxen. This engine of war, together with its wheels, was upwards of fifteen feet from the ground. On these frames he made open spaces to move about in, and strong defenses, and on each of these turrets he mounted twenty men. When he had completed these turrets, and tested their draft by experiment with eight yoke of oxen, with the twenty men thereon mounted, he found it could be drawn with more ease than a single yoke had formerly drawn the common baggage-weight, for the weight of baggage was about twenty-five talents (about fourteen hundred and twenty-five pounds) to each yoke; but the draft of a turret whose wooden frame was as broad as a tragic stage, together with twenty men and their arms, amounted to but fifteen talents (about eight hundred and fifty-five pounds) to each yoke. Some of these chariots were so high that when mounting, as in the case of Abradatus, they did so "by the door of the driver's seat," shutting the door after them. This operation, on a certain occasion, deprived Panthea of the pleasure of kissing her husband; so, having no other way of saluting him, she "kissed the seat of the chariot," in testimony of affection.

Afterwards these scythe-chariots were tried in an encounter with the chariots of the Egyptians in the army of Cæsus. By the rapid movements of the horses, the Egyptian vehicles were overturned, and, being cut to pieces, men, arms, horses, and wheels, and whatsoever these scythes came in contact with, were destroyed, throwing everything into inexpressible confusion. But poor Abradatus, being excessively jolted in passing over the heaps of all kinds which his bravery had caused, fell with others of his party, and was cut down and killed by his own instruments in the confusion which followed. This battle, although Cæsus lost his faithful ally therein, yet gained for his scythe-chariots such a world-wide fame that they were used by his successors for many years afterwards.

These scythe-chariots, by some termed "sickle-wagons," have been the theme of controversy with subsequent writers, to the criticisms of whom we now direct the attention of the curious reader. Quintus Curtius, in giving an account of the battle between Alexander and Darius, tells us that the latter had "of chariots, armed with scythes, two hundred, the grand dependence of the barbarians, as they imagine such machines panic-strike an enemy. Each was drawn by four horses abreast. The four poles [one between each pair of horses] were armed in front with projecting iron spears; the transverse beam, in position [the splinter-bar of modern carriages], but massy, to which the horses were yoked, carried at either end three swords. To the spokes of the wheels shorter blades were latterly appended, and to the felloes were fastened scythes; other scythes pointed [from the axle-trees] towards the ground, to mow in pieces everything in the way of the precipitated car."¹

Le Clerc, who seems to have taken much pains in weakening our faith in the veracity of Curtius, remarks that, "in his description of the hooked chariots, he has these words: 'At the end of the pole long spears were fixed, pointing forwards; and on each side from the body

¹ Quintus Curtius, B. IV, ch. 9, London, 1809. In giving an account of this among other things, Arrian says: "Before the left wing, facing Alexander's right, stood about a thousand Scythian and Bactrian horse, and a hundred armed chariots; and around Darius's royal guard were elephants and about fifty chariots. Before the right wing stood the Armenian and Cappadocian horse and about fifty armed chariots." — Rooke's *Arrian*, Vol. I, p. 137, London, 1814. It is not here said that the fifty chariots with the royal guard were armed, but the probability is they were, and if so, the number, agreeable to Curtius, is confirmed.

of the chariot three swords were placed. This is not difficult to be understood, but what follows would be extremely difficult, if not altogether unintelligible, unless we depart from the propriety of the words, and understand not so much what Curtius said as what he would have said. And among the spokes of the wheels more spears stand forth, directed right forwards; some scythes were fixed aloft to the highest part of the circumference of the wheels, and others below towards the earth, to cut in pieces whoever lay prostrate or fell in their way.

"Among the spokes of the wheels, properly speaking, nothing could stand forth which would not stop the motion of the chariot. Besides, what means he by 'right forward'? Can spears stand forth and not point right forward? Then what are the highest parts of the circumference of the wheels? Are they not the ring or rounding? If so, in the ring or rounding there is neither higher nor lower part while the wheel is in motion, because every part thereof is highest and lowest by turns. Curtius understood it thus, as appears by what follows: 'And others fixed below, towards the earth.' How could scythes be fixed at the lowest extremity of the ring [rim] of the chariot which would not hinder its motion? John Scheffer¹ judged rightly that this description was very much entangled and imperfect, and so it was deemed by Godese Stevechius and Matthæus Raderus, insomuch that neither of them durst venture to take a draft from it. But wherever Curtius had this description of a hooked chariot, he seems not to have understood his author from whence he took it. He ought not to have said that the scythes stood forth from among the spokes, but from the nave [hub] of the wheel; then, that two scythes stood forth from the end of the axle-tree, one right forward, about the length of the axle-tree itself; the other transverse, and pointed towards the ground. The scythes and spears thus standing forth from the wheels or axle-tree, and that bent downwards from the axle-tree, were not only designed to cut and tear in pieces all who stood in their way, but also to destroy all those who happened either to be thrown down by the horses or the tumult and hurry of the people, and lay not far distant.

¹ John Scheffer was a German scholar who wrote a book entitled *De Re Vehiculari* in the Latin language, which was published at Frankfort by Johannis Andreae in 1671, pp. 422, fifty-four pages of which at the end are occupied with a work, *De Vehiculis Antiquorum*, by Pyrihi Ligorii, a Neapolitan, "*nunquam ante publicata.*" This last is briefly written in Italian, of which a Latin translation in parallel columns is printed.

“That this, or something like it, was the form of the hooked chariots, I am fully assured, having the evidence of two ancient authors on my side, the one a Latin, the other a Greek. Livy thus describes them: ‘The hooked chariots were most commonly armed after this manner: the two scythes which they had from the beam were shaped like horns and full ten cubits in length, wherewith they tore and rent in pieces whatsoever they met; and at the end of the axle-tree two others stood forth, one right forward and the other pointing downward, to cut asunder and make havoc of whatever lay near them.’¹ For these four scythes Curtius has three swords, which are not capable of doing half the execution. The rest he thus describes: ‘Also at the naves of the wheels, two others were fixed in the same manner as the former.’ Curtius aimed at something like this, in these words: ‘And other scythes in the highest part of the circumference,’ etc. But his description is absurd, and would be unintelligible if Livy did not help us to his meaning. Diodorus Siculus, discoursing of hooked chariots, gives us this description of them: ‘From each of them,’ says he, ‘at the end of the pole were fixed spears of three spans in length, looking directly against the enemy’s ranks.’ This answers to the former part of Curtius’s description, and what follows to the latter: ‘And in the nave of the axle-tree (that is, beneath the chariot, where the axle-tree holds it up) two other darts stood out, pointed in like manner against the enemy’s ranks, but broader and longer than the former. Scythes were also fixed upon these extremities (that is, the ends of the axle-trees).’ I fancy from these or some such like descriptions, ill understood, Curtius has taken his absurd and imperfect one; for which see John Scheffer, who has taken some pains to reconcile Curtius to common-sense by substituting naves for the outermost ring or circumference. But to me it is no wonder that a man, used all his life-time to

¹ Livy, B. XXXVII, ch. 41. Plutarch, *In Lucullo*, says of these scythe-chariots (*currus falcata*): “Hujusmodi pugnacis vehiculi genus, quo armis prætor movis videri instructior, reperit Parthiæ pugnæ necessitas, sed hoc, singulis bene munitis investit equis, duo viri, vestior et armis, ferro diligenter muniti, citato cursum in pugnam rapiunt, ejus posterior supra currum pars, cultus in orbem extantibus communitur, videlicet ne facilis à terga cuiquam præbeatur ascensus; falces vero acutissima axibus ejusdem currus aptantur, in lateribus suis ansulas habentes, quibus inmixti funes pro arbitrio duorum equitum, laxata quidem explicant, repressi autem erigunt falces, qualia vero hujusmodi machinæ funera hostibus immittant, vel quas turbatis ordinibus strages efficiant, dicent melius qui usu bella cognoscunt.”

declaiming, should err in such a description; and I would not have Scheffer, or any one else, pretend to make him skilled in military terms, in spite of all the manuscript copies of his work."¹

John Scheffer's efforts "to reconcile Curtius to common-sense," alluded to by Le Clerc, are illustrated with two figures of wheels by himself, which we reproduce here. They are evidence of the author's ingenuity, but as settling the question in dispute, of not much value.

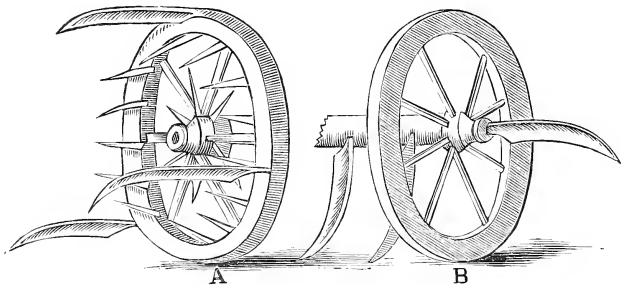

ANCIENT SCYTHE-CHARIOT WHEELS.—FROM SCHEFFER.

The wheel as described by Curtius is shown at A, that of Diodorus Siculus at B. The first, as a *cutting* machine, would prove a failure; for *tearing*, it would be effective. The arrangement of the knives at B would better answer the purpose of mowing down the ranks of an enemy, *could they be induced to stand for the trial*.

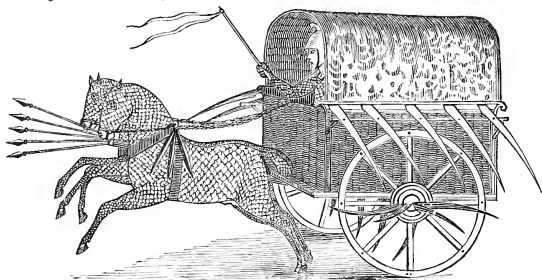

GALLICAN COVINUS.—FROM GINZROT.

Ginzrot thus speculates: "I think the scythes were attached, not on the felloes, but above them, on the body, in order to allow the wheels to turn

¹ Le Clerc's criticism of Curtius, prefixed to the fourth chapter of Arrian, London, ed. 1814.

unobstructed. In this way the scythes had a firm hold, and could inflict more damage than if they had been applied to the wheels or felloes and revolved with them. Nearly all writers treating on this subject are of this opinion, and Curtius says: '*Alias deinde falces summis rotarum orbibus hærebant*' [that is, other scythes were fixed above the wheels, from thence curving downward]. The scythes could easily have been attached to the body, as the engraving shows, and, notwithstanding, it might be said they extended over the felloe, for Curtius said, not that the scythes revolved with the wheels, but 'hærebant' [they were fixed]. We have to remark that our picture is not designed to represent the chariot described by Curtius, but a Gallican covinus, or battle-wagon, mounted with scythes all around. Just as well might scythes be applied to bodies made by the Persians, which originally looked like a Grecian 'diphron,' but later were made closed all around."

The learned in subsequent times "have tired themselves with suppositions, and given in their works all kinds of engravings, which, instead

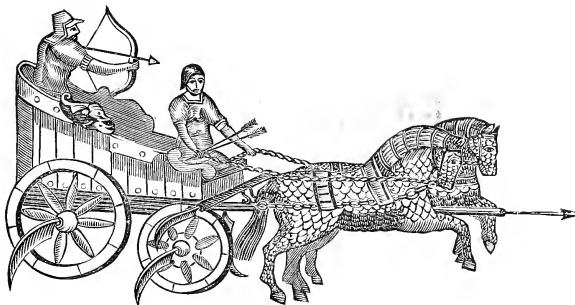

SCYTHE-WAGON BY A MODERN INVENTOR.

of furnishing a clearer idea of the thing, have rather made it more confused and less comprehensible. Some are rather to be admired as works of art than to be accepted as quick-moving vehicles.

"Most of these *savans* had but little experience in the art of carriage-building, and did not care much if the picture they furnished of them could or could not be imitated [in wood], provided they embodied their own idea and description. He who wishes to convince himself of this fact may examine the edition of Stechevius by Vegetius, or the edition of Raderus by Curtius, or Potter's "Greek Archæologia," and

he will find it hard to understand how Stechevius and others conceived the idea of representing such wagons with four wheels, and mounting the horses with harness without a yoke, as in our days; for all the old writers who studied them well left no room for this supposition. The scythe-wagons, which were similar to the ordinary battle-wagons, had only two wheels, and it would be useless to construct them with four.



ANCIENT SCYTH-WAGON.—FROM A RARE PRINT.

is fitted for turning quicker in any direction than a four-wheeled one. The old authors treating on this subject affirm that scythe-wagons required level territories to be used to advantage; for between outstanding roots, bushes, woods, and rocks, the scythes attached would soon have been demolished.”¹

Another writer thus comes to the rescue, and tells us that “the difficulty which Scheffer, Crevier, and Drakenborch apparently had in interpreting this passage with the reading (*decem cubita*) seems to me to have arisen principally from their misinterpretation of the word *cuspis*, which in the classics is nowhere used as the edge of a cutting, but the point of a piercing instrument: ‘*Differt a mucrone, que est acies gladii.*’

¹ Ginzrot's *Wagen und Fahrwerke*.

(Facciolati.) That the *cuspides* here spoken of must have been piercing, not cutting instruments, is likewise proved from the meaning of the word *transfigerent*, which is never used in reference to a cutting instrument. Taking it for granted, then, that the '*cuspidibus decem cubita*' were spears ten feet long, fastened to the pole and extended from the yoke, I can easily understand how they, being so long, were likely to clear the way far in front of the horses, while the '*falces*' on either side were intended to cut down those who escaped the '*cuspides*'; and this being the case, I see no necessity for Scheffer's reading '*cubito*,' which Crevier also seems to favor, and Drakenboreh's '*duo*' for '*decem*,' both of which seem to have been adopted owing to the seeming improbability of cutting-weapons so long and proportionably heavy being attached to the poles of chariots."¹

Leaving this discussion for the present, we proceed to give examples in which these scythe-chariots figure as instruments of warfare, the result of which will throw some light upon the subject as to their efficiency.

In the battle between Alexander and Darius at Arbela, the latter had about fifty chariots armed with scythes attached to the army of the Arachosians, besides which Phradates led a powerful body of Caspians supported by fifty more, and a savage horde bringing an additional fifty, with levies of Armenians, Cadusians, Cappadocians, Syrians, and Medes with still another fifty.²

"At Absares, in India, Porus sent forward his brother Hages against Alexander with one hundred war-chariots and three thousand cavalry. Porus's chief strength lay in chariots; each carried six men, — two targeteers, two archers disposed on each side, and the remaining two were drivers, not indeed unarmed, for in close engagements, laying aside the reins, they showered javelins on the enemy. On this day, however, these machines were of small avail, for an unusually heavy rain, as already narrated, having fallen,³ made the ground perfidiously soft and unfit for riding, and the ponderous and almost immovable

¹ Note to Bohn's edition of Livy, B. XXXVII, ch. 41.

² See Quintus Curtius, B. IV, ch. 9. The battle of Arbela, between Alexander and Darius, was fought A. C. 320, A. M. 3674. We have seen, on page 99, that chariots captured from the nations named in this paragraph, by the Persians, were altered by Cyrus into scythe-chariots some years previous to Alexander's expedition into India.

³ Quintus Curtius, B. VIII, ch. 14.

chariots were arrested by the sloughs and torrent-gullies. Alexander, on the contrary, rushed fiercely to the charge with an active and light-armed force. The Scythæ and the Dahæ began the onset; then Alexander detached Perdicas with a body of horse against the enemy's right wing. . . . The charioteers, deeming their vehicles to be the last resource of their associates, drove with loose reins into the midst of the field and equally damaged both parties; for at first the Macedonian infantry were trampled down by their inroad, then the chariots whirled upon slimy and unequal places and shook the drivers from their seats; other cars the affrighted horses precipitated into the ravines and pools, and even into the river; a few, having been conducted as far as the enemy, reached Porus, who was vigorously stimulating the battle.

"The Indian leader, perceiving his chariots dispersed over the field, floundering without directors, distributed the elephants to his tired friends. Behind them he had stationed his infantry and archers, these carried drivers, whose accent served the Indians instead of the trumpet's call; nor were the elephants disturbed by the noise; their cars were docile to the known sound."¹

About three years after this, at the river Hydraotes, the barbarians met him (Alexander) with war-chariots fastened together; some had darts, some had pikes, some battle-axes; they were seen actively leaping from car to car to succor such combatants as were severely pressed. At first this new way of fighting startled the Macedonians, as they were wounded before they could come into close action. At length, despising so irregular an armament, having surrounded the chariots, they began to spear their fierce adversaries. That these machines might beset singly, the king ordered the ligaments by which they were connected to be cut. Eight thousand Indians having thus fallen, the rest sought refuge in the town.² Seven years previous to this, when Alexander marched against the Thracians, that people obstructed his progress with war-chariots on a mountain, planted so as to resemble

¹ See Quintus Curtius, B. VIII, ch. 15 (A. C. 327, A. M. 3677). Where, in the battle with Porus, Curtius represents the Indian archers to have been incommoded by the slippery state of the ground, Rooke marks it among his important objections, because Arrian (B. V, ch. 15) describes the place where the Indian army was drawn up as firm and sandy; but it is evident from the beginning of that chapter in Arrian that the field was interrupted and surrounded with slimy tracts. — *Vindication of Curtius*, Preface to the edition published in London, 1809, by Samuel Bagster, sect. viii, p. 32.

² Quintus Curtius, B. IX, ch. 1.

an intrenchment, intending to roll them down on their assailants. Alexander, understanding their plans, gave orders to his soldiers to open to the right and left on their approach and let them pass without mischief, ordering such Macedonians as were not quick enough to do so to fall flat down, covering themselves with their bucklers, as its impenetrable shell covers the tortoise.¹

When Cæsar was attacked by King Pharnaces, near the town of Ziela, the king, in order to frighten the Romans, had a line of scythe-chariots brought to the front, but the panic-stricken soldiers, the veterans especially, soon recovered themselves, and made an awful slaughter in the ranks of the enemy, gaining a victory for Cæsar. It was in reference to this battle, because it was gained speedily with ease, that Cæsar, on his triumphal entrance into Rome afterwards, had carried in the procession before him that famous inscription, "*Veni, vidi, vici*" (I came, saw, conquered). These scythe-chariots used to be drawn up at the beginning of a battle at some distance in front of the enemy. It was too dangerous to let them advance through the ranks of the foot-soldiers, as it often happened that the horses got frightened, and, running back, caused a great massacre in their own ranks instead of those of the foe.

The *currus fulcata* of Antiochus, described by Livy, appear to have been different from those invented by Cyrus. He tells us that "round the pole were sharp-pointed spears which extended from the yoke about ten *cubita* [about fifteen feet]; with these they pierced everything in their way. On the end of the yoke of the two outside horses were two scythes, one being placed horizontally, the other towards the ground. The first cut everything from the sides, the others catching those prostrate on the ground or trying to crawl under. There were also on both ends of the axle scythes going out in different directions. The long spears (*cuspides*) were not on the yoke, as some say, for how could it have been possible that such spears could stand firmly straight forward and pierce enemies? Such were attached to the tongue, the end of which did not reach out one foot over the breast of the horses, as in our wagons, but just terminated before the yoke; it follows that Livy only intended to say that the part of the spears

¹ See Arrian, B. I, p. 2 *et seq.*, and the Supplement to the London edition of Quintus Curtius.

running out from the end of the pole was ten 'cubita' long, measured from the yoke.¹

"Ginzrot observes that the *fundales* or side-horses in the olden times were mounted with small yokes, and on these were fastened the holders, the surcingles, and the poitrals. In this way it was possible to attach to a quadriga scythes at a small yoke. But to have scythes reaching from the middle yoke over the backs of the side-horses would not have been advisable, but dangerous for the side-horses. This mode could only have been applied to *bigas* [two-wheeled vehicles] where there were no side-horses."²

Lampridius informs us that Alexander Severus, in a speech before the Roman Senate, set forth that, having conquered the Persians with seven hundred elephants and killed two hundred of these, he adds: "We destroyed two hundred scythe-chariots of the one thousand taken. I did not want them, as they can be easily imitated everywhere."³ Artaxerxes, who renewed the fight with Alexander Severus, disposed in order of battle one thousand scythe-quadrigas, besides seven hundred war-elephants, with one hundred and twenty mounted soldiers.

The Persians had a vehicle they called a *harmamaza*, similar to the *carpentum* of the Romans. These were more popular with women and effeminate youths than with men. Cyrus was very anxious to increase his cavalry, and the example of the great went to encourage the rich youths to devote themselves to this exercise; for as they were at that time in the habit of riding in chariots, they made very poor horsemen and indolent warriors. For this reason Agesilaus sold the Persian prisoners naked, they never having exposed any part of their bodies, having always ridden in chariots, so that they looked so white and delicate that his soldiers, seeing them, thought that they had to fight with women. This carriage, supplied with cushions, was often used as a bed by the king on a march. The ordinary war-chariot was called a *harma*, which, being only fitted to sit on and stand in, was sometimes temporarily abandoned for the more comfortable and aristocratic

¹ Livy, B. XXXVII, ch. 41.

² *New York Coach-maker's Magazine*, Vol. VIII, p. 35.

³ Alexander Severus was the twenty-first emperor of Rome, for ten years, from A. D. 222 to 232. Lamprid., in *Vit. Alexandrii Severi*. He received his name from the fact that he was born at Arcæna, in a temple dedicated to Alexander Magnus, king of Macedon.

harmamaxa, as did Xerxes on his march against Sardis.¹ This harmamaxa appears to have on some occasions answered the purposes of a state chariot, in comparison with which harma, the common peasant vehicle, was a very insignificant affair.

From our drawing the reader will get a very clear idea of the Persian carpentum or harmamaxa. This vehicle is referred to in old authors.

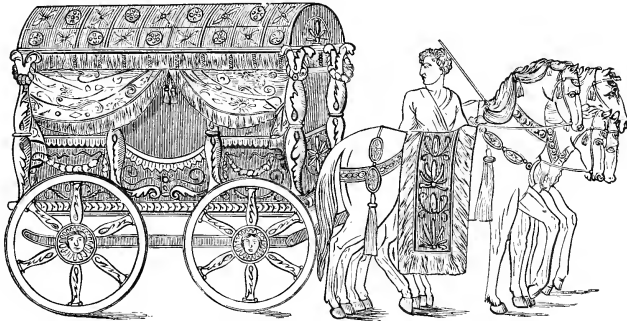

PERSIAN HARMAMAXA.

Maximus Tyrius (Serm. 34) says, "Thou art astonished at the Median tiara, the barbarous board, and the Persian harmamaxa"; and Curtius has retained the word in Latin by saying, "Then followed fifteen so-called harmaxens." The body of this vehicle was mounted on four wheels and had a closed box all around, and was long enough to lie down in; the side-rail of which on each side was cut out rounding in the middle, to facilitate ingress or egress when required, the outside hangings being richly decorated, and the inside covered with soft cushions and other upholstery. The Persian ladies are said to have reclined in them as on a bed, or sat on the cushions according to the Oriental custom. According to Herodotus, the women rode in *camerata*, or arched vehicles. Xenophon says on one occasion ("Cyrœpædia," B. III), "Cyrus permitted even the women, who were present in their harmamaxa, to listen." The Persians and other Orientals seem to have been very solicitous about their wives, from jealousy as well as affection. King Cræsus permitted his wives that accompanied him on his warlike expeditions to travel only by night, in order

¹ Herodotus, B. VII, v. 41.

that they might not suffer too much in their closed harmamaxa from the heat of the day. Plutarch tells us that "the Persians surrounded their wives carefully with a guard, in order that they may not be seen by any of the servants, and when they travel they ride in closed harmamaxens." Diodorus Siculus says, "It was customary among the Persians for those who had to escort a mistress of the king from one place to another to do it in a closed carriage, so that no one who met them might exhibit curiosity in regard to its occupants, or might ask to see her." By this method Lysithides succeeded in his schemes, in bringing Themistocles to Xerxes on one occasion. Xenophon observes in one passage that "the Asiatics are accustomed to take their concubines and most valuable property with them when they go to war, for they believe they fight with more courage if they have to defend what is most dear to them."

That the Persian ladies often went to the wars in the most magnificent chariots is evident from the words of Herodotus (B. VII, ch. 83). After the Greeks had conquered the Persians at Platea, a woman fled and surrendered to them. It was the concubine of Pharandates, a Persian prince. She sat in a harmamaxa quite brilliant with gold, and her maid-servants were dressed in the most gorgeous attire.¹ These were sometimes drawn by oxen as well as horses, like the carpenta. Demosthenes in "Mid." says, "Lysistrata, wife of one of the richest citizens of Athens, always drove four white Seythian horses to her harmamaxa"; and Heliodorus describes the procession of Diana with the Thessalonians, and says of their priestess Chariclea, "She rode in a harmamaxa drawn by a yoke of white oxen."² It is proved from a passage in Xenophon that both men and women sometimes rode in these harmamaxa. He says, "After the Armenian princes were reconciled with Cyrus, and had embraced him, they stepped with their wives into the harmamaxen."³

Diodorus Siculus calls the state funeral carriage, built by Hieronymus for carrying the body of Alexander from Babylon, where he died,

¹ Herodotus, B. IX, ch. 76.

² Heliodorus, *Ethiop.*, B. III.

³ Xenophon's *Institution of Cyrus*, B. III. From the extracts we have given in the text it would appear that ancient writers did not take much care in selecting proper names for the vehicles they intended to represent, or else the word "harmamaxa" described a certain vehicle in general use among different nations. Harmamaxa probably was the common name for four-wheeled, as the word "chariot" was for those on two wheels.

to the temple of Amun in Alexandria, Egypt, where it was deposited, a harmamaxa; and Athenæus tells us that Hieronymus "won great admiration by the manner in which he built the harmamaxa in which Alexander's corpse was carried away."¹

The body of this car, as will be seen from the engraving, rested on two axle-trees, on the journals of which revolved four richly carved wheels, the spokes and felloes of which were gilded and bound by tires.

On the ends of each axle, covering the linchpins, was a cap in the form of a lion's head, holding in the mouth an arrow. The peristyles, or columns, were gold, with Ionic capitals, on which rested an arched roof of gold, wrought and bound together with festoons of scales, set with precious stones. Outside the arch, on the edge, were fringes of wrought gold in the form of a net, from which were suspended large

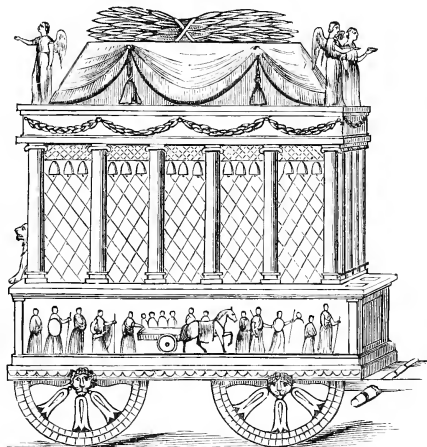

ALEXANDER'S FUNERAL CAR.

bells, which, when the car was in motion, could be heard at a considerable distance. On each corner of this arch stood figures of Victory holding trophies in their hands. A golden acanthus was trailed around each pillar to the capital; upon the center of the arch, on the outside, was thrown a purple tapestry, on which was laid an olive wreath of gold, which, reflecting in the sun, was seen at a great distance. At the entrance to this carriage stood two golden lions, as if to guard the passage. Under the arch, nearly the length of the floor, was placed a four-cornered golden throne, ornamented with chiseled bucks' heads, from which hung wide golden rings, to which wreaths, splendid in

¹ A very fine engraving of this vehicle will be found on Plate I of *Monuments et Ouvrages Antiques Restitués*, by M. Quatremere De Quincy, Paris, 1829.

colors, were attached. In the peristyle was a good net of a fringe's thickness, furnished with four tablets represented in bass-reliefs, and duplicated on the outside. On the first, Alexander was seen with a scepter in his hand and sitting on his armor; on the other, the Persian *melophosces* (apple-carriers, so called because they carried large golden buttons on their lances), and behind these armor-bearers. On the second tablet elephants were represented carrying the Macedonian

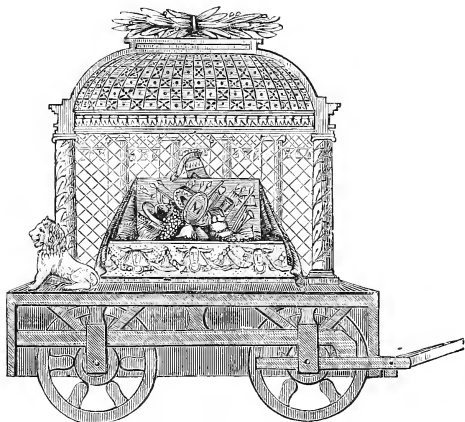

INTERIOR VIEW OF ALEXANDER'S FUNERAL CAR.

body-guard, with Indian drivers. On the third were squadrons of horse in evolution. On the fourth, a fleet getting ready for action.

On the throne was placed the golden coffin, half filled with aromatic spices to perfume the body, of wonderful workmanship, covered with a lid of gold and a pall of purple color worked in gold, on which was laid the armor of the dead. The remainder of the description given by the ancient historian refers chiefly to the manner in which the sixty-four mules which drew the ponderous car were yoked to it, and is here omitted, having very little interest for the general reader. There is one thing worthy of notice in connection with this subject, and that is, in order to prevent any violent movement in turning, or passing over uneven ground, the builder put a perch-bolt in the "under-carriage," that the body might under all circumstances preserve a proper position and not upset.

Hieronymus, who seems to have been a Persian, and to have copied his chief points of construction from the already popular *harmamaxen* of the country, established an envious fame in so doing, great numbers of people from long distances coming to see it in connection with this gorgeous funeral procession.

The Persians of the present time are far behind some other nations. The farmer's cart, as used at Khosrovah, is far from being the perfection of art. The wheels are of the most primitive kind ; and then, indeed,



PERSIAN FARMER'S CART.

who would think of hitching buffaloes to a cart in this age of the world? The rude vehicle is pretty well loaded with passengers and market-baskets, a musician accompanying it to enliven the party with tunes played from a rustic pipe. Such is life in Persia.

CHAPTER IV.

GRECIAN RACING AND OTHER CHARIOTS. — ETRUSCAN BIGAS.

“High o’er the well-compacted chariots hung
 The charioteers ; the rapid horses loosed
 At their full stretch and shook the floating reins.
 Rebounding from the ground, with many a shock
 Flew clattering the firm cars, and creaked aloud
 The naves of the round wheels.”

HESTIOD'S *Shield of Hercules.*

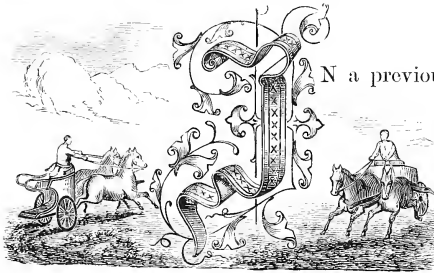

IN a previous chapter we have attributed the invention of chariots to the Egyptians, as we think on sufficient evidence, although this is a matter of dispute among Grecian and Roman writers.

In the Hymn to Venus, Homer distinctly says that Mars first taught mortal workmen to make wagons and various kinds of chariots in brass;¹ whilst the invention of the use of chariots is ascribed to Erichthonius, the fourth king of the Athenians, who, to hide his dragon-shaped foot, rode in one. Herodotus tells us that the Greeks² learned

¹ See Bohn's edition of Homer's *Odyssey*, p. 387.

² Greece is supposed to have been settled by the descendants of Javan, otherwise called Ion, the son of Japhet, and grandson of Noah; for in Hebrew, as linguists teach us, the same letters, differently pointed, form these two different names. (Dan., ch. viii, v. 21.) Among the Hebrews, Chaldeans, and Assyrians, the Grecians were known only as Ionians. — Grecian history covers the space of two thousand one hundred and fifty-four years, commonly divided into four periods, the first beginning with the petty kingdom of Sicyon, A. M. 1820, and ending with the siege of Troy, *circa* A. M. 2820, previous to which time the Grecians do not appear to have placed much confidence in chariots as instruments of warfare. The second period begins with the taking of Troy, A. M. 2820, and ends with A. M. 3483. At this date its history becomes intermixed with the Persian, in the reign of Darius, the son of Hystaspes. The third period

to harness four horses to chariots abreast from the Libyans.¹ Virgil informs us that Erichthonius was the first who ventured to hitch four horses to a chariot for the race-course,² whilst the Arcadians, according to Cicero, concede the invention of wheeled vehicles to Minerva.³ Pliny, with greater probability, says the Phrygians invented the putting of two horses to a chariot, but likewise agrees with Virgil in ascribing the honor of hitching four to Erichthonius. We learn from the pages of Herodotus that long before the Athenian ruler was born, the Egyptians, in performance of certain ceremonies in honor of Mars at Papremis, carried his image in procession, seated in a miniature temple, mounted upon a four-wheeled vehicle, thus contradicting the speculations of the later historians.⁴ Notwithstanding, it must be conceded that in beauty of outline and nicety of finish the Grecian architects were far in advance of their contemporaries in chariot-building. This will appear as we proceed with our history.

The Grecian carriage nomenclature, although less extensive than the Roman, was not an insignificant one by any means. The general employment of vehicles is very evident. Mure observes "that modern travelers have long been in the habit of remarking the frequent occurrence of wheel-ruts in every part of Greece, often in the remotest and least frequented mountain-passes, where a horse or mule can now with difficulty find a footing. The term 'rut' must not here be understood in the sense of a hole or inequality worn by long use and neglect in a level road, but of a groove or channel purposely scooped out at distances adapted to the ordinary span of a carriage, for the purpose of

extends from A. M. 3483 to the death of Alexander, A. M. 3641. This was the most prosperous period of its duration, and the point when art had reached its highest perfection. The fourth commences with the death of Alexander, A. M. 3641, ending A. M. 3974, when Greece became subject to Roman power. Supposing that art reached its climax among the Egyptians, Assyrians, and Grecians at the periods we have stated, we may fix the chronology of the carriages as follows: the Assyrian, seven hundred and seventy-four years later than the Egyptian; and the Grecian, sixty-three years later than the Assyrian.

¹ Herodotus, B. IV, ch. 189.

² The poets especially, in ancient times, taking advantage of the license accorded them, have done more in falsifying history than any other class of writers. In this case the *honor* assigned Erichthonius rests on a very *sandy* foundation.

³ "Quarta Minerva, Jove nota Coryphe, oceanæ filia, quam Arcades Coriam nominant et quadrigarum inventricam fecerunt." — CICERO, *De Nat. Deorum*, B. III, v. 23.

⁴ Herodotus, B. II, ch. 63.

steadying and directing the course of the wheels and lightening the weight of the draft on rocky or precipitous ground, in the same manner as the sockets of our railroads."¹

On ancient coins and vases² are many designs of Grecian chariots, commemorative of victories in the races, or in memory of the nuptials of persons noted for their deeds, as in the instance of Peleus and Thetis. The *antyx* or frame-work of a chariot was usually of wood, and sustained the other parts of the body, which were sometimes of osier, but most commonly of leather or raw hide.³ The engraving shows the frame-work of a *diphron*⁴ or war-chariot, which, with the exception of the top ring, were the same in bigas and the quadrigas used on the

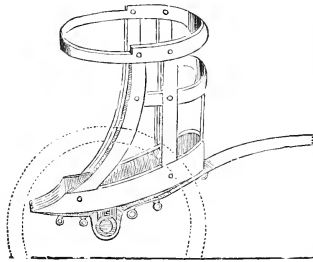

DIPHRON.

race-course, in triumphal and for pleasure driving. The wooden portions of the bodies were made very strong, as, being hung upon the axle-tree without any contrivance for breaking the force, they were often subjected to severe joltings, especially when they carried more than one passenger. All the joints were put together very nicely, and secured with glue made from hide-clippings or isinglass, which, according to Celsus,

was called *ichtycolla*. The *antugen*, or metallic circle which formed the top finish of this description of chariot, was generally brass, but sometimes wood, very light and tasteful. Instead of hide or osier as mentioned above, sometimes the side panels were deal and painted. The sides of war-chariots were much deeper than those used in the circus, the high sides serving as a protection to the warrior against the darts of the enemy. When these sides were low and open, a better

¹ Mure's *Travels in Greece*. The late researches of Dr. Schlieman among the ruins of Mycenæ show that the ruts of chariot-wheels are so deep from constant friction that they form a striking object in his discoveries.

² See Gerhard's *Griechische Vasenbilder*, 3 vols., Berlin, 1840; Overbeck's *Geschichte Plastik*, Vol. I, Leipzig, 1857; and Windust, *On the Portland Vase*.

³ See Pollux, B. I, ch. 10, *seq.* 142.

⁴ In the Grecian tongue, war-chariots were called *diphros* (two-seated), and sometimes, too, *synoris* (or double team). These were of various kinds.

view of the fine dresses and beautiful figures of the Grecian ladies was obtained than when otherwise constructed.

In the larger portions of chariots the raves were curvated, forming a sort of projecting ring on each side at the rear, the object of which was to aid the passenger in mounting or dismounting. In front was a raised rail, usually lined, as a protection against accident under fast driving, or to prevent being thrown out while turning the *meta*, or boundary in the race. This likewise served as a fastening for the reins when the driver left the car, or wished to relieve himself from holding them.

Plato describes a chariot as consisting only of wheels, axle-tree, body, and pole, which in fact comprehends about all there is of it.

These axle-trees were usually made of beech-wood, but occasionally of iron, being secured to the bottom of the body by screws and "brandrele" or eyelets. When iron axles were used, these eyelet-bolts, in case of breakage, held the arms, and saved the vehicle from falling to the ground, and perhaps killing the charioteer. That the rims of chariot-wheels were sometimes made of poplar-wood is indicated by a passage in the *Iliad* which reads thus: "He [Simoisius] fell on the ground in the dust, like a poplar which has sprung up in the moist grass-land of an extensive marsh, whose branches grow smooth even to the very top, which the chariot-maker lops with the shining steel, that he may bend [it as] a felloe for a beauteous chariot."¹

The more common way with the Grecians was to harness two horses abreast. These, according to Homer, were "fed on lotus,"² "lake-fed parsley,"³ "white barley"⁴ and "oats"⁵ from "ambrosial mangers,"⁶

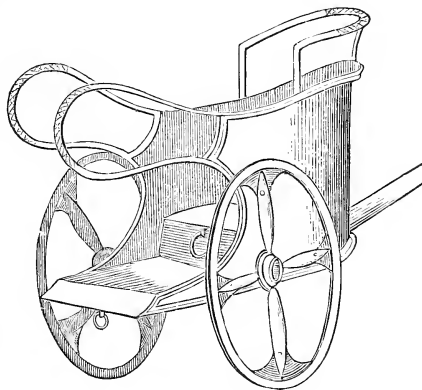

GRECIAN CHARIOT.

¹ Homer's *Iliad*, Bohn's Edition, B. IV, p. 77.

² *Ibid.*, B. II, p. 45.

³ *Ibid.*, p. 45.

⁴ *Ibid.*, B. VIII, p. 150.

⁵ *Ibid.*, p. 150.

⁶ *Ibid.*, p. 147.

to which his "fair-maned" steeds were bound. The Grecians appear to have given names to favorite horses. Those of Achilles were respectively Kanthus, Babius, and Pedasus.

It is noticeable that in all Grecian chariots very few trappings are shown. The vehicle is therefore supposed to have been drawn from the yoke alone. This yoke was placed horizontally on the necks of the animals, near the extremity of the pole, supported by the inner horses, thus allowing them larger freedom; the two flank horses in quadrigas being more for show than anything else, although fastened to the ends of the yoke by straps secured to the collars. A girth is frequently seen on the horse, preventing the collar from turning. The heads of all were kept together by coupling reins.

Pausanius informs us that the temples and other public edifices of Greece were decorated with trophies, some of which were bronze.

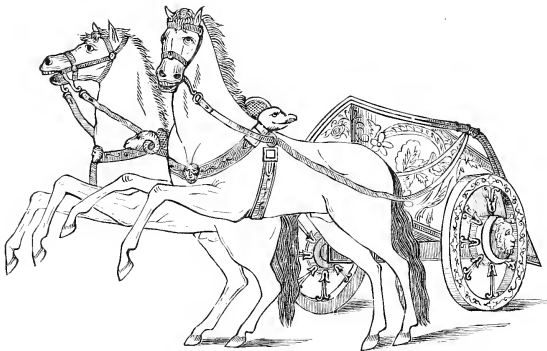

GRECIAN CHARIOT, A TROPHY TO ROME.

He particularly refers to bigas and quadrigas—twenty-four in number—filled with one or more human figures, accompanied by couriers and men on foot. These were consecrated

to the gods with other spoils, out of gratitude for success in war. A chariot of this description is shown in the engraving, in perspective, a side view being seen in the next figure. The original was dug up near Rome, and is now deposited in the museum of the Vatican, where it may be seen by the visitor. This relief, in white marble, supposed to have been captured from the Grecians by the Romans, could scarcely be excelled by modern artists. Such is the splendor of this model that we are inclined to think that Homer's poetical *shadings* merely describe real objects. The body is antique, but some other portions,

including the wheels, pole, and yoke, have been restored. The off-side horse, all except the head and legs, is as originally made, and the near horse, all except the left hind foot and right fore one, have been supplied. The bridles originally were bronze. The shape of the body

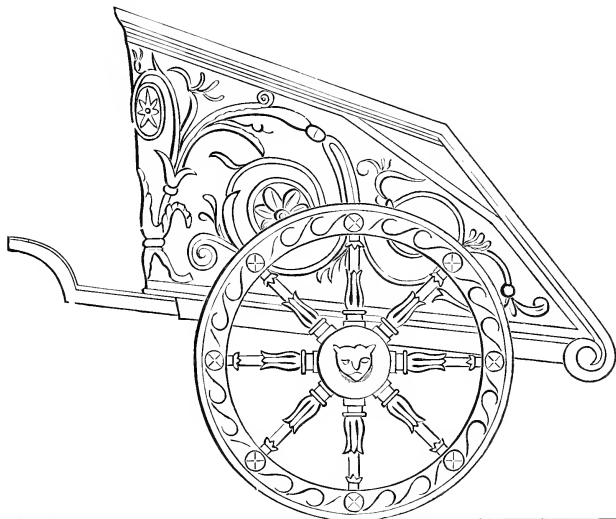

SIDE VIEW OF GRECIAN CHARIOT.

is remarkable. The front, instead of being rounded, exhibits the form of a heart, the upper rave consisting of two thick rounded bars. The ram's head on the extremity of the pole, the snake-headed yoke, and the lion-faced hub-cap, are each worthy of special notice.

To publicly exhibit the chariots of the vanquished was practiced among the ancients from the earliest times. For this purpose a selection was made from the finest to grace the triumphs of returning heroes and conquerors as a mark of gratitude to them. These were afterwards laid up in the halls of the temples, or placed in the public squares, or fixed over the gates of the city, or deposited in the sepulchers. Sometimes these trophies were preserved in the same state as when captured; at other times they were newly ornamented and gilded, and after being filled with other spoils taken from the enemy

in battle, horses of wood, marble, and iron were attached to them. In some instances the conqueror's coat-of-arms, and generally an inscription on the pedestal, was added, showing the name of the hero and the purpose for which the monument was erected.¹

Most of the drawings of Grecian design exhibit no linchpins. It does not necessarily follow from this fact that such were not used, for we are told that Myrtilus, the charioteer of CEnomaus, allowed his master to be conquered in the race, his unfaithful servant having removed the iron linchpins and substituted wax ones instead, so that the wheels of the chariot came off during the contest.

Of all the games celebrated in Greece, none have excelled or even approached in renown the Olympian. They occupied the first place in the minds of the people, having been instituted by Hercules, the first of heroes, in honor of Jupiter, the first of gods, and were celebrated every fourth year. So popular were these games (B. C. 4000) that they were utilized in ornamenting the pediments of public buildings and other monuments of the ancients. Among Stuart's "Antiquities

¹ The practice of setting up monuments in memory of remarkable events dates as far back as patriarchal times. Jacob set up the stone on which his head rested while dreaming as a memorial of his vision, consecrating it by pouring oil thereon (Gen., ch. xxviii, v. 18), and Joshua ordered twelve stones erected as a remembrancer of the passage of the Israelites over the Jordan. (Josh., ch. iv, v. 3.) But only in honor of God or with some pious intention was it lawful to set up monuments among the Hebrews, all others being strictly prohibited. (Deut., ch. xvi, v. 22.) The heathen adopted the same practice in later times; for when a citizen retired from business, he dedicated to the gods some choice implement, sometimes made of silver, hanging it upon the arches of the temple. Gladiators, retiring forever from the arena, consecrated their armor to Hercules. Gordius devoted his farm-wagon to Jupiter, placing it in his temple after having been offered an empire for it while riding therein. (Justin, B. VI, ch. 9.) Charioteers on relinquishing their occupation devoted their chariots, yokes, bridle-bits, and reins to some temple, generally that of Neptune. Catullus makes the mariner say, "O my ship, I consecrate thee to Castor and Pollux!" (*Carm.*, ch. lxviii, v. 65.) Timon in *Lucian* exclaims, "Thou, my dear leather jacket and pickax, I devote to Pan." Longus says of Daphnis, "To Dionysius he consecrated pouch and fur, to Pan a flute and lyre, and to the nymphs his shepherd's crook." (*Daphnis and Chloe*, B. VI.) Carrión, in *Aristophanes*, dedicates his old overcoat and shoes, which he wore in poverty, to Pluto. Lais, a courtesan of Corinth, is thus immortalized by Julian:—

"Lais, when time had spoiled her wonted grace,
Abhorred the look of age that plowed her face.
Her glass, sad monitor of charms decayed,
Before the queen of lasting bloom she laid.
'The sweet companion of my youthful years
Be thine,' she said. 'No change thy beauty fears.'"



CHARIOT FROM THE PEDIMENT OF THE PARTHEON.

of Athens" there are three compartments allotted to the chariots from the Partheon.¹ In the first are two; in the second another, showing preparation for the race; in the third, the crowning of the successful competitor standing over his chariot, as shown in the illustration on the preceding page. Although somewhat roughly executed, it is undoubtedly a fair exhibition of the style of Grecian chariots then prevalent.

In the Grecian games, as previously intimated, the chariot-races were the most distinguished, and consequently occupied the attention of the most noble and ambitious minds of the age. Nothing was comparable to a victory around the stadium, since it was looked upon as the perfection of human glory. A Roman poet has pronounced the successful contestants something more than human, — *no longer men*, but gods.²

This distinguished honor was in a great measure derived from the ancient practice of the Egyptians and Assyrians in fighting from chariots, as already described. Ancient writers inform us that kings in person eagerly contended for these high honors, under the conviction that the title of victor in the race was scarcely inferior to that of a conqueror in battle, and that the victor's wreath — composed of olive, pine, and parsley — would lend additional splendor to a throne. Pindar, in one of his finest odes, teaches us that Gelon and Hiero, kings of Syracuse, held this opinion, of which we find other examples in classical history. Cypselus, usurper of the government of Corinth, maintained a stud of horses expressly for the chariot-races. His son Miltiades on one occasion won a prize, which served to place his family in the very highest respectability. Democritus, king of Lacedæmon, was renowned for the honor he had conferred on his native city by a victory in one of these contests with a four-horse chariot, he being the only individual in Sparta ever thus successful. Cimon, who had been banished from Athens by Pisistratus, during his exile at Marathon had the good fortune to win a prize in another four-horse chariot-race, the honor of which he transferred to his brother Miltiades. Afterwards, in the next Olympiad, having gained a second victory with the same

¹ See Stuart's *Antiquities of Athens*, John Nichols, London, 1787-1816.

² "Palmaque nobilis
Terrarum dominos evehit ad deos." — HORACE, B. I, Od. I.

mares, he permitted Pisistratus to be proclaimed victor, by which act of generosity he was allowed to return home under certain conditions. In another trial he was a third time successful with the same animals. Alcibiades was noted for the great number of chariots he kept, and for the superior breed of his horses. At one time he sent seven chariots to the Olympic races, — a thing never done by any other person, whether king or in the private walks of life. According to Thucydides, he bore away the first, second, and fourth prizes at one time, which exceeded everything previously performed in that line by the most ambitious.¹ These he won in person. Afterwards he obtained two others by proxy. On one occasion his passion for these sports got him into trouble. It seems there lived at Athens one Diomedes, a man of good character and the friend of Alcibiades, who exercised a strong desire for winning a prize in one of these races; and being told that a chariot belonging to the city of Argos was for sale, he persuaded his friend, who was exceedingly popular there, to buy it for him. Alcibiades, after purchasing the chariot, ungenerously kept it for his own use, leaving Diomedes to vent his wrath in calling upon gods and men to bear witness of the injustice done him in this transaction. There appears to have been a suit afterwards brought against the ancient sportsman by the disappointed would-be victor, an account of which may be found in an oration by Isocrates, wherein a defense is made in the interest of Alcibiades, then a youth. The great expense Alcibiades was at in sacrifices to Jupiter, and in feasting his friends who assisted him when contesting the game in person, is strong evidence that he felt great pride and much joy at his success. On the day Alexander was born, his father, the king of Macedon, obtained the victory in a chariot-race, of which he was so proud that he afterwards had the event recorded by a representation of it on a coin. This passion for racing does not appear to have been inherited by his son; for when questioned by his friends on a certain occasion as to whether he intended to enter the list or otherwise, he with seeming indifference merely said, "Yes, if I have kings for my antagonists!" We frequently find impressions of chariots on the coins of the ancients. There is one from Syracuse in the British Museum, on one side of which may be seen a quadriga, the successful charioteer standing therein while being

¹ Thucydides, B. VI, 16.

crowned by Victory. A representation of the usual racing-chariot is

given in the engraving.

The honor obtained in these contests was not confined to the sterner sex, as appears from history. Pausanius says that Cynisea, the sister of Angেসilais, king of Sparta, was the first female crowned victor in a chariot-race, to whose honor also a monument was afterwards erected. As the lady herself had previously caused a chariot of brass, drawn by four horses, in which a charioteer was shown in a standing posture, to be made and deposited in a Delphic temple, it is probable that her victory was won by proxy, — a very convenient mode of obtaining renown in ancient times.

ANCIENT GRECIAN RACING-CHARIOT.

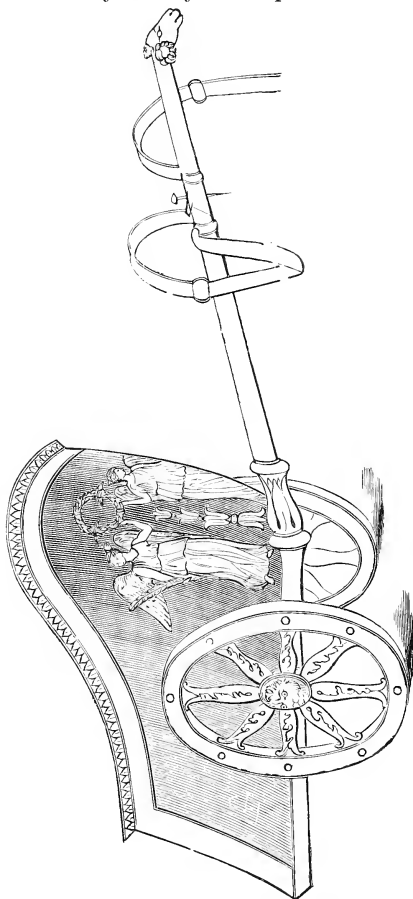

off together from the *carceres*, — a Latin term for the place of starting, — the position of each chariot having been determined by lot. The individual fortunate enough to obtain a place on the left was supposed to have gained something in his favor, as in turning around the bounda-

ries, provided he did not fall too far in the rear before reaching them, the inside chariot would have a shorter distance to run than those on the right and nearer the outer side of the circus. After running twelve times around the circus, he whose chariot came in first on the last round was proclaimed the victor.

It is evident that much skill was required in those who followed the profession of charioteer or driver, which could only be attained by constant practice; consequently the choice of persons for that office was not a matter of small moment. We learn from history that drivers were chosen necessarily from people of the highest rank in society, as the position was one of the greatest responsibility. It required no small ingenuity, in combination with constant practice, to qualify the driver so as to expertly manage his horses, that in turning the boundary his lack of skill might not terminate in a loss of the prize, likewise in death. Nestor, in Homer, instructs Antilochus by saying, "One man who is confident in his steeds and chariot, turns imprudently hither and thither over much [ground], and his steeds wander through the course, nor does he rein them in. But he, on the contrary, who is acquainted with stratagem, [though] driving inferior steeds, always looking at the goal, turns it close, nor does it escape him in what manner he may first turn the course with his leatheru reins; but he holds on steadily and watches the one who is before him. But I will show thee the goal easily distinguished, nor shall it escape thy notice. A piece of dry wood, as much as a cubit, stands over the ground, either of oak or of larch, which is not rotted by rain; and two white stones are placed on either side, in the narrow part of the way, but the race-course around is level; either it is the monument of some man long since dead, or perhaps it has been a goal in the times of former men, and now swift-footed noble Achilles has appointed it the goal. Approaching this very closely, drive thy chariot and horses near, but incline thyself gently towards the left of them [the steeds], in the well-joined chariot-seat, and cheering on the right-hand horse, apply the whip and give him the rein with thy hands. Let thy left-hand horse, however, be moved close to the goal, so that the nave of the well-made wheel may appear to touch the top [of the post], but avoid to touch upon the stone, lest thou both wound thy horses and break thy chariot in pieces, and be a joy to others and disgrace thyself."¹

¹ *Iliad*, B. XXIII, pp. 427, 428.

The skill displayed by some ancient charioteers was truly astonishing. Plato gives an account of one Anniceus, a native of Africa, who was very dexterous in handling the reins. This dark-skinned charioteer, being desirous of giving the celebrated philosopher proof of his ability in presence of a great multitude, drove several times around the Academy with so steady a rein as to have left but one print of his chariot-wheels. Domitius, the son of Cneius, in his youth was famous for his skill in this business.¹

Probably no better description of the Grecian chariot-race can be found anywhere than the one given in the "Electra" of Sophocles, a poetical translation of which is subjoined:—

“They took their stand, where the appointed judges
 Had cast their lots, and ranged the rival cars.
 Rang out the brazen trump! Away they bound,
 Cheer the hot steeds and shake the slackened reins.
 As with a body, the large space is filled
 With the huge clangor of the rattling cars.
 High whirl aloft the dust-clouds, blend together,
 Each presses each; and the lash rings; and aloud
 Snort the wild steeds, and from their fiery breath,
 Along their manes and down the circling wheels,
 Scatter the flaking foam. Orestes still,
 Aye, as he swept around the perilous pillar,
 Last in the course, wheeled in the rushing axle,
 The left rein curbed, that on the dexter hand
 Flung loose, — so on erect the chariot rolled!
 Sudden the Ænian’s fierce and headlong steeds
 Broke from the bit; and as the seventh time now
 The course was circled, on the Libyan cars
 Dashed with wild fronts. Then order changed to ruin:
 Car crushed on car; the wide Crissæan plain
 Was, sea-like, strewn with wrecks. The Athenian saw,
 Slackened his speed, and, wheeling around the marge,
 Unscathed and skillful, in the midmost space,
 Left the wild tumult of that tossing storm.
 Behind, Orestes, hitherto the last,
 Had yet kept back his coursers for the close;
 Now, one sole rival left, on, on he flew,
 And the sharp sound of the impelling scourge
 Rang in the keen ears of the flying steeds.
 He nears, he reaches, they are side by side;

¹ Suetonius in *Nero*, c. 3.

Now one, now th' other, by a length the victor.
 The courses all are past, the wheels erect,
 All safe, when, as the hurrying coursers round
 The fatal pillars dashed, the wretched boy
 Slackened the *left* rein. On the column's edge
 Crashed the frail axle; headlong from the car,
 Caught and all meshed within the reins he fell;
 And, masterless, the mad steeds raged along."

On many Greek vases there are figures of chariots supposed to

illustrate subjects taken from Homer,¹ of which the engraving is a specimen. It represents Eos as the Goddess of the Morning, about to commence her journey for the day. In this design there appear but three horses attached to a chariot. Although many of these vase-pictures may to a certain extent be the fanciful creations of the potter, still they undoubtedly, in a greater or lesser degree, represent the prevailing modes of vehicular art in those times.

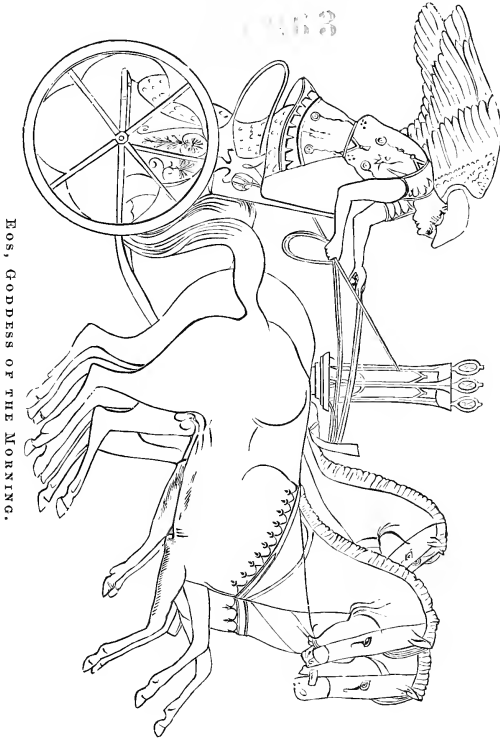

EOS, GODDESS OF THE MORNING.

¹ This most eminent of Grecian poets, according to the Arundelian marbles, flourished in the tenth century B. C., the contemporary of Daniel and Solomon, about two

In Millingen's volume we find an imperfect representation of a car drawn by two horses, in which is seated a young man dressed in a red tunic, going at full speed. The car is hung very high, and the wheels are singularly constructed without either hubs or spokes, instead of which are three bars, one much stronger than the others, placed diametrically, and perforated in the middle to admit the end of the axle-tree, and is crossed at right angles by the other two bars. The horses have neither reins nor harness, but are yoked to the car like oxen. Instead of bridles, head-stalls alone are shown, designed

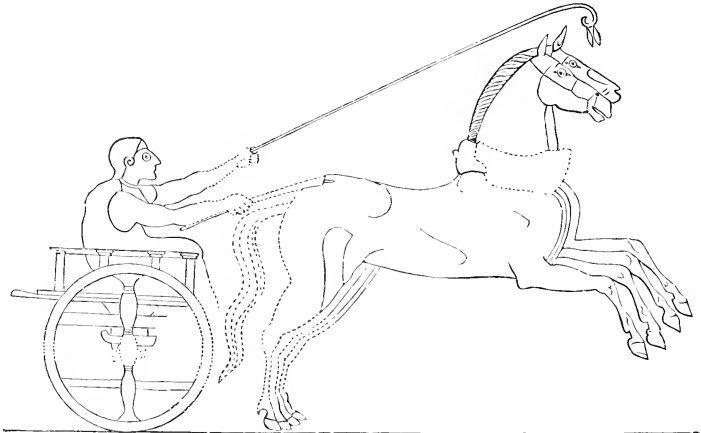

HORSES GUIDED BY A STAFF.

to keep the horses together, the collars supporting the yoke or transom-bar fitted to the end of the pole. The driver, contrary to the usual custom when racing, in this instance is seated. Instead of reins he uses a long staff in guiding his horses, which is bent at the end like a shepherd's crook, similar to the manner practiced in Italy at the present day for driving oxen. At the end of the crook are two articles apparently of metal, for producing sound, designed to animate the horses, instead of bells. In the other hand of the driver there is a

hundred years after the destruction of ancient Troy. Flaxman tells us that "Homer supplied subjects for both painters and sculptors, who imbibed electric sparks from his poetic fire."

goad, and a red spot on the flank of one of the horses is indicative of its effect. This mode of driving a team is said to have been practiced by the Libyans and other African nations. Even in later times the Numidian cavalry would never adopt the use of bridles, but drove their horses by the goad and the voice.

The next illustration, from an ancient Grecian vase, is supposed to represent the flight of Priam from Troy on its being sacked and burned

by the Greeks, as described by Homer.¹ Æneas, his son, it is said, rescued his father and his household gods, but on the way lost his wife Creusa.²

On the sarcophagus which among other things enclosed the celebrated Portland Vase, now deposited

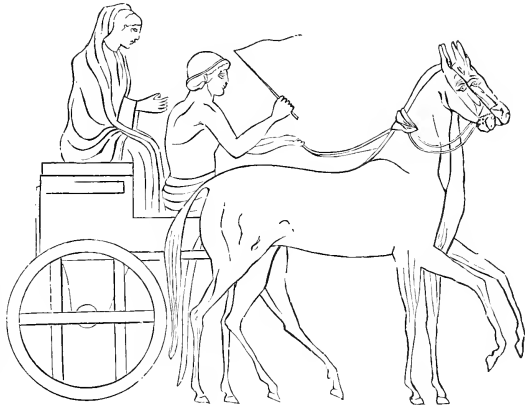

GRECIAN WAIN, FROM A VASE.

in the British Museum, appear two chariots, the one drawn by horses, the other by mules. In the group, Galen, from Pergamus, in Asia Minor, is made to personify Priam, king of Troy. This monarch, the poet tells us, Hermes conveyed invisibly to the tent of Achilles, to solicit of him the dead body of Hector, as detailed in the twenty-third book of the Iliad. In the subject the Trojan is found in a supplicating posture at the feet of Achilles, who, turning away his head in disdain, refuses to entertain his plea. In the distance there is a chariot filled with presents, and nearer by an empty one for receiving the body. Both are attended by Ethiopian servants.³

The next design, from another Grecian vase, represents Mars, the

¹ Some modern skeptics deny that Troy ever existed, and say that Homer is a myth.

² Virgil's *Æneid*, B. II.

³ See Windust, *On the Portland Vase*, p. 87.

God of War, as just stepping into his chariot, attended by soldiers in armor. In this case the god chooses to act the part of charioteer as well as combatant on the field, although among the ancients the warrior was ranked higher than the driver, the former having the sole direction where to drive. By acting the part of charioteer, the immortal seems to have compromised his dignity in the eyes of mortals.

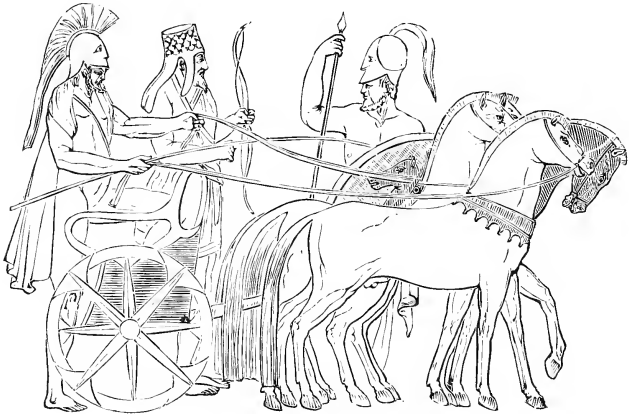

WAR-CHARIOT OF MARS.

According to Homer, the Grecians took special pains to have their war-chariots "well fastened" and "well made" to stand the concussion and strain of battle, and considered it much safer to remain in them while the conflict was maintained, than to alight and fight on foot, as some other nations did. In these contests, "with blood the whole axle-tree was stained beneath, and the rims around the chariot-seat, which the drops from the horses' hoofs and from the wheel-tires splattered."¹ It is said that the steeds of Mars were "gold frontleted,"² and that the "Carian women tinged ivory with purple color to be a check-trapping."³

The chariots of Homer's epic are quite smothered in adjectives. He tells us they were "curiously made,"⁴ with round fronts,⁵ well joined,⁶ well wheeled,⁷ and "brass mounted,"⁸ furnished with "well-formed

¹ *Iliad*, Bohn's Edition, p. 205.

² *Ibid.*, p. 90.

³ *Ibid.*, p. 67.

⁴ *Ibid.*, p. 327.

⁵ *Ibid.*, p. 107.

⁶ *Ibid.*, p. 195.

⁷ *Odys.*, p. 81.

⁸ *Iliad*, p. 74.

seats,"¹ and were given as splendid presents² to Jupiter, Neptune, and other immortals.³ Minerva's "shining chariot" is described as having "a beechen axle-tree groaning beneath its weight on a certain occasion when it bore a dreadful goddess and [Diomedes] a very brave hero."⁴ The minute description of Juno's chariot in the fifth book of the *Iliad* is extremely beautiful. We subjoin a free translation: Juno on her part, venerable goddess, daughter of mighty Saturn, quickly moving harnessed her gold-caparisoned steeds; but Hebe [the daughter of Jupiter and Juno, afterwards the wife of Hercules] speedily applied to the chariot axle-trees of iron, the curved



GRECIAN LADY'S QUADRIGA.

wheels golden, with eight spokes. Indeed, the felloes of these were gold imperishable, and around them were fastened brazen tires, wonderful to the sight; but the circular naves on both sides were of silver. The body, from which projected a silver pole, had a circular rim doubled, and was suspended on thongs of silver and gold. At the extremity [of the pole] she fastened the beauteous golden yoke, and to it attached the beautiful golden paitrels. But Juno, longing for battle and conquest, led the swift-footed steeds under the yoke.⁵

Besides the above, we have Jove's "beauteous-wheeled chariot," Menelaus's "well-made chariot," Agamemnon's "brass-variegated chariot," and Ulysses's "well-wrought chariot-seat." In other passages we

¹ *Iliad*, Bohm's Edition, p. 310.² *Odys.*, p. 327.³ *Iliad*, pp. 136, 229.⁴ *Ibid.*, p. 103.⁵ *Ibid.*, p. 100.

read of the "well-polished chariot," and of the seats, that they were "well formed" and "well joined." Added to these we have "the well-glued car" of Achilles, — from which it appears that gelatine was as important an article in ancient as in modern times, — "the well-wheeled mule-drawn car" in use at the funeral of Hector, and learn furthermore that the Greeks yoked both oxen and mules *beneath* their wagons. So much were chariots in esteem that "they tilted the chariots against the splendid walls,"¹ or were taken into the tent and "covered up with a covering."² All who have studied "the Old Man of Aserca's" immortal epic will see that he entertained a very high opinion of chariots, for he has placed the Thunderer and his erratic spouse therein, as well as other deities of lesser fame, and sent them off to the wars with becoming dignity.

Similar expressions to those of Homer are found in Hesiod. He has mention of "well-framed cars,"³ "well-compacted chariots,"⁴ "well-wheeled chariots,"⁵ and "crooked [curved] cars,"⁶ etc. He likewise speaks of wagons and carts to which mules and oxen were yoked for use in agriculture.⁷ This old author even tells us the time when it is best to fell timber, and says that it should be in autumn, after the leaves have fallen.

"For then the star of day with transient light
Rolls o'er our heads, and joys in longer night.
When from the worm the forest bolls are sound,
Trees bud no more, but earthward cast around
Their withering foliage, then remember well
The timely labor, and thy timber fell.
A three-foot mortar, and of cubits three
A pestle hew, and seven-foot axle-tree:
Commodious length, if eight the ax beside.
Hew the curved blocks for felloes, and sustain
On wheels three spans round the ten-span wain."

Lucian says that the princes and princesses of Greece were accustomed to use splendid chariots on private occasions.⁸ The engraving may represent one of this kind, being low at the sides, as we have previously observed, that the dress might be seen to good advantage. These Grecian ladies appear to have exhibited much taste and some

¹ *Iliad*, Bohn's Edition, p. 147.

³ *Shield of Hercules*, Elton's Translation, l. 89.

⁴ *Ibid.*, l. 411.

⁶ *Ibid.*, l. 437.

⁷ Hesiod's *Works and Days*, ll. 45-56.

² *Ibid.*

⁵ *Ibid.*, l. 627.

⁸ Lucian, B. V.

pride in their flowing robes of variegated color, especially when they went out for a chariot ride, as they often did, as is proved by numerous passages in classic story.

On the large limestone slabs covering graves recently unearthed by Dr. Schliemann at Mycenæ are several representations of chariots. One such has a figure of a warrior,



GRECIAN LADY'S BIGA.

standing up in the chariot, drawn by a horse with widely extended legs, showing him at great speed. The wheel has only four spokes, forming a cross, as at page 123. Another slab represents a warrior in a chariot, with a broadsword in the left hand, and a long lance in the other thrust into the neck of a fantastic-looking animal on the run. In front of the pierced animal stands another man with a large knife in his right, holding the horns of the animal with the left hand, partially concealing the horse in the chariot. Probably these all have symbolical meanings.

Anticipating chronology, — as we do not intend to devote a chapter to the subject, — we add a specimen of Etruscan chariots from an ancient vase, of which there is a very large collection in the British Museum. The *antugen*, or curved rave of the Grecian chariot, is a prominent feature in the Etruscan, which appears to have been copied

after it, and which, as far as is now known, was not adopted by any other nation. The picture appears to represent a contest between

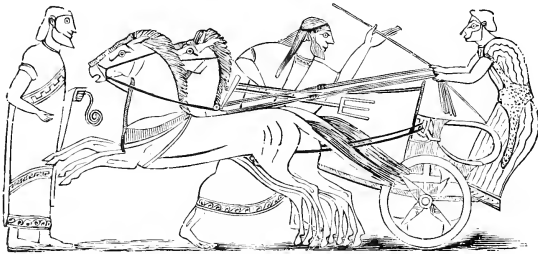

ETRUSCAN BIGA.

Neptune and Hercules, as indicated by the trident and the lion's skin. Persons curious in such matters will find numerous examples of this nature in

Christie's volume, among them a quadriga in which a man is seated, the car being preceded by Mercury, "petasated and booted," bearing the caduceus, with an attendant marching beside the horses beckoning another person on. This figure is supposed to represent some deity as being on the way to harmonize the universe.¹

It is a matter of some regret, that, without occupying too much space, we cannot pursue this subject further. A comparison of the chariots of Etruria with those of Greece, of which it was a colony, would prove a profitable field for study. Those interested will find the volumes named in this chapter in the Astor Library, New York City.

¹ Christie on *Etruscan Vases*, London, 1825, p. 69.

CHAPTER V.

ROMAN VEHICULAR ART AND ITS ASSOCIATIONS.

“Primus Erichthonius currus et quatuor ausus
 Jungere equos rapisusque rotis insistere victor.
 Frena Pelethroniū Lapithæ gyrosque dedere,
 Impositi dorso : atque equitem docuere sub armis
 Insultare solo, et gressus glomerare superbos.”¹

VIRGIL'S *Georgicon*.

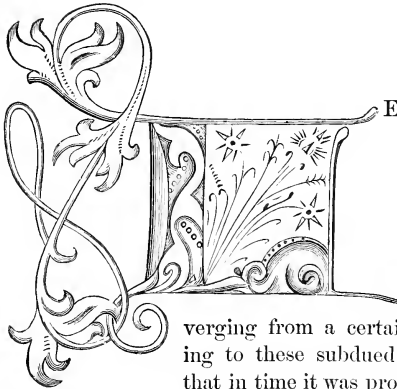

REGIONARY Rome having brought the neighboring countries into subjection, the next thing to be done was to maintain her power and keep them submissive. With this end in view, the Romans constructed military roads, diverging from a certain point in the city, and leading to these subdued provinces in all directions, so that in time it was proverbially said that “all streets led to Rome.”² These roads were so substantially built that traces of them still remain. Over these “royal highways” the wealthier class of citizens were accustomed to drive, exhibiting a degree of splendor

¹ Thus rendered by Sotheby :—

“Bold Erichthonius first four coursers yoked
 And urged the chariot as the axle smoked.
 The skillful Lapithæ first taught to guide
 The mounted steeds, and rein their tempered pride ;
 Taught under arms to prance and wheel around,
 Press their proud steps and paw the insulted ground.”

² Rome was first settled by a colony from Alba Longa, — a city said to have been founded by Ascanius, the son of Æneas by Creusa, — under Romulus, who with his twin brother Remus is fabled to have been suckled by a wolf, about A. C. 753. In the course of time she became the mistress of the then known world. It conferred distin-

never before seen in daily life. To such an extent was this carried in the middle of the first century that people who aspired to fashion appeared on the Appian or Flaminian roads, or in excursions to their villas out of town, with trains of Numidians mounted on horses brought from Africa, who, riding before the carriages of the wealthy Romans, gave notice by the clouds of dust they raised that some great man was on the move.¹

The Romans appear to have had a greater variety of vehicles than any earlier nation. This doubtless was in consequence of their having superior roads and more tempting offers for display. Although these Roman carriages have been carelessly mixed up with those of Greece by other writers, we shall endeavor in the course of this chapter to present the different varieties in a proper light before the reader.

The earlier mode of travel was in the *lectica*, or sedan, supposed to have been introduced into Rome from the East towards the end of the Republic, the Emperor Claudius being the first to use one with a canopy. These were borne on the shoulders of four slaves, as has been done in later times, the construction of those for women differing from those used by men. In the time of Julius Cæsar, these litters were a prescribed article to all under a certain age on certain days, as well as purple robes and jewels.² Subsequently litters so increased in numbers as to incommode travelers in the public thoroughfares.

Following the sedan was the *basterna*, chiefly borne by mules. Cicero tells us that Verres made use of one superbly decorated, the cushions being stuffed with roses. This had a seat in the center on which the traveler sat upright. Such was the estimation in which they were held in the reign of Domitian, that infamous women were forbidden to ride in them.³ The travel in these was so slow that Augustus took two days in reaching Præneste on the Tiber. For this reason he pre-

guished honor on an individual to be called a Roman citizen. Unless promoted to some public office, the law gave a father the power of life and death over his children, as long as they lived, if sons; and over the daughters until given away in marriage.

¹ "Omnes jam sic peregrinantur, ut illos Numidarum Juæcurrat equitatus, atque ut agmen cursorem antecedit; turpe est nullos esse, qui occurrentes via dejecerant; qui honestum hominem venire magno pulvere ostendant." — SENECA, *Epist.*, 123.

² "Lecticarum usum, item conchyliatæ vestis, et margaritarum, nisi certis personis, et atatibus, perque certos dies, ademit." — SUET., *C. J. Cæsaris*, ch. 43, et *Claud.*, ch. 28.

³ Suet., *Domit.*, ch. 8.

ferred going by sea.¹ On one occasion, while traveling in the night, his basterna was struck by lightning, the same bolt killing the slave carrying the torch before him.² In illustrating the difficulties of travel, we need only mention that Tiberius, finding his litter obstructed by bushes, once ordered an officer of the first cohort, whose duty it was to ride ahead and examine the roads, for neglect, to be laid with his face to the ground and scourged until he was nearly dead.³

One of the earlier as well as the most popular vehicles was the *carpentum*, named in honor of Carmenta, the mother of Evander. It



CARPENTUM, TEMP. CALIG.

was sometimes called the covered litter, which latter it appears to have supplanted. These were frequently represented on Roman coins. One issued during Caligula's short reign (A. D. 37-40, Y. R. 790-793), in honor of the infamous Agrippina, is shown in the engraving. Historians tell us that the *carpentum* was frequently lined with costly cloths and profusely ornamented. It was decidedly the ladies' carriage, often devoted

to conveying the images of such females as had been decreed divine honors under the Empire by the Senate and people of Rome.⁴ Under the Oppian law, the women for certain reasons were, during the second Punic War, forbidden its use.

About fifty years later (A. D. 90) the like honor was shown Julia in the reign of Domitian. The *carpentum*, as seen by comparison, has undergone some changes, — among others, had the sides of the top enclosed. Livy informs us that the *carpentum* was sometimes used for carrying the matrons in procession on funeral occasions, but this distinctive privilege had to be obtained by special decree from the Roman Senate. This carriage usually had seats for two, but on some occasions it was provided



CARPENTUM, TEMP. DOMIT

with another for the accommodation of a third person and the driver.

¹ Suet., *Aug.*, ch. 82.

² Suet., *Aug.*, ch. 29.

³ Suet., *Tib.*, ch. 60.

⁴ "Matri *carpentum*, quod per Circum duceretur." — Suet., in *Claud.*, ch. 11.

Some of these vehicles were so luxuriously finished, and crowded by women, children, eunuchs, and lazy men, that Juvenal found occasion for making the practice a subject of satire.¹

Carpentum seems to have been the generic term for different descriptions of covered two-wheeled vehicles. They were employed in various forms for town uses, traveling, and even for wedding occasions. On the night of a marriage the bridegroom bore away the bride from her father's house to his own dwelling. Seated on the right of his bride,

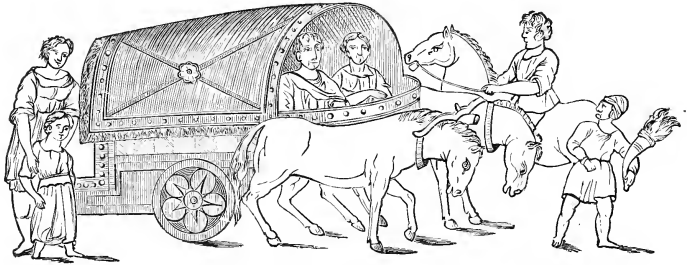

CARPENTUM.—CARRYING OFF THE BRIDE.

with a confidential friend on her left, the *carpentum* was driven through many of the public streets, the friends of the parties leading the way, while the servants and slaves followed after the carriage. From the windows the bridegroom scattered nuts among the spectators, shouting, "*Spargere marite nuces!*"²

The *carpentum* with four wheels, a rare thing, seems to have been used almost exclusively by emperors, princes, and the chief officers

¹ "Prætor majorum cineres atque ossa volueri
Carpento rapitur pinguis Damasippus, et ipse,
Ipse rotam abstringit multo sufflamine consul;
Nocte quidem; sed luna videt, sed sidera testes
Intendunt oculus."—JUVENAL, *Satire*, VIII, 146.

Thus literally rendered: "By the ashes and bones of his ancestors the fat Damasippus is hurried in his rapid *carpentum*, and himself, himself a consul, locks the wheel with a long drag-chain; by night, it is true; but the moon sees, but the stars [as] witnesses, stretch their eyes [towards him]." This vehicle is the *apene* of the Greeks.

² "*Spargere marite nuces*," signifying thereby that he had relinquished all childish amusements for the state of manhood. A ceremony akin to this is still practiced in our day, wherein a shoe is thrown *after* the carriage of a newly married pair by the friends to signify luck. The humorists tell us that this practice is designed to show that the chances of matrimony are very *slippery*.

of state. They were seen at the circus festivals on opening days, bearing the lares and penates (household gods) of this idolatrous people, among which they placed the images of deified Caesars, many of whom were devils incarnate, and guilty of the most revolting crimes known among men. Like the *pilentum*, hereafter introduced, the *carpentum* was usually hung on swinging poles, having higher wheels than the chariot, with wooden side panels two feet high. The entrance was at the back end of the vehicle, through a door hung upon hinges, in the manner of some modern carriages, fitted with a kind of lock to fasten it. Four caryatides (human figures) or other effigies formed the pillars, gilded, or else of ivory, gold, or silver, supporting the canopy or covering. This covering, as before mentioned, was often a richly colored cloth, embroidered with silver or gold, or both, and overlaid with laminae or tiles, and sometimes the sides were enclosed with entire sheets of that metal. The interior trimmings were richly wrought stuffs, stuffed to make them soft, and the seat, accommodated for reclining, was trimmed with the same material, and embroidered with gold, silver, precious stones, and pearls. These seats were hung on straps to a cross-bar, the hanging strap, which fitted flat to the sides of the body, being fastened to straps which grasped the seat. A step facilitated entrance behind. From some examples it appears that windows at the side were often made in the *carpentum*. These, we are told, ran in grooves, and were raised or let down at the pleasure of the occupant. The *glasses* of these were made of *talc*, thin horn, bleached selenite, or moon-stone serving as transparencies. These windows were furnished with inside curtains or blinds of painted linen, frequently embroidered. The back and front were furnished with appropriate curtains, which could be drawn aside at pleasure.

Among the Romans a wide difference prevailed in driving carriages, whether on special or ordinary days. The *carpentum pompaticum*, or state coach, was only allowed by the Senate to such persons and their families as had gained distinction by their public actions for the good of the state, and the honor on all public festivals was strictly confined to such in the procession. While on ordinary days no particular rule was observed in public, and particularly in sacred processions, no one was suffered to appear who had no right by law, and those who had the right were not allowed to drive in any vehicle unless sanctioned by custom. According to Tacitus, this custom or law continued for a

long period, until the infamous and ambitious Messallina, the wife

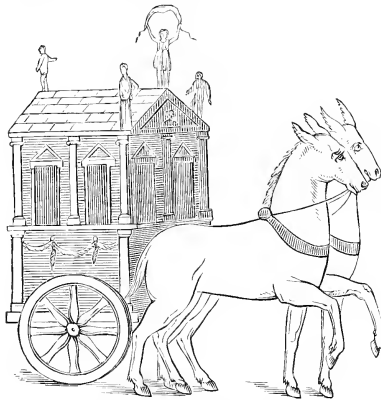

CARPENTUM POMPATICUM.

of Claudius Cæsar, regardless of the feelings of the Roman people, rode into the capital on a *carpentum*.¹ When afterwards ladies of distinction rode to the capital in solemn procession, it was considered an act of pride and presumption on their part.

Another very soft and comfortable carriage was called the *pilentum*.² This was fashionable among all classes. It was a special favorite with the Roman ladies. Its light construction when compared with

other Roman vehicles seems to have greatly recommended it to general use. According to Livy³ and others, this, the most popular of all Roman carriages, was the favorite vehicle with the matrons when they visited the temples to perform the sacred rites or mysteries of their religion. From a passage in Virgil ("*in mollibus pilenti,*"—in the easy *pilentum*) some have inferred that the *pilentum* was suspended

¹ "Carrum ejus Messallina uxor carpento secuta est."—Suet., in *Claud.*, ch. 17. Such was the recklessness of Claudius that at one time he ordered a car plated with silver, of very sumptuous workmanship, which, after being exposed for sale in the street *Sigillaria*, he had purchased, to be broken in pieces before his eyes. Suet., in *Claud.*, ch. 16.

² The name is said by some writers to have been derived from *pilens*, a hat, the *pilentum* in some instances having a half-round top or roof; and by others from *pila*, a pilaster, four of which supported the covering, as shown in the engraving on the opposite page. Adams represents the *pilentum* as having four wheels in some instances, in which he differs from other authors better qualified to judge.

³ "Honorem ab eam munificentiam ferunt matronis, habitum ut *pilento* ad sacra ludosque, *carpentum* festo profestoque uterentur."—Livy, V, 25. On one occasion, when the Senate found that gold could not be obtained in sufficient quantity to discharge a vow it had made to Apollo, the Roman matrons came forward with their coin and ornaments, and cast them into the public treasury. The grateful Senate, in rewarding this generosity, decreed that the matrons thereafter might use covered chariots (*pilentum*) when going to public worship and the games, and open chaises on festival and common days.

on poles or straps, or some other contrivance, rendering them easy riding; but all such conjectures are evidently mere speculations, unsupported by any pictorial evidence existing in our day. The wheels appear to have been much lighter and higher than in most other Roman vehicles; and this fact, in connection with their light and airy construction generally, is sufficient, by comparison, to entitle them to the qualification "easy," particularly so to the draft-animals.

The roof was sometimes supported by long and slender pillars, the sides having only narrow festoon curtains, being left entirely open at the sides and ends so as to expose the occupants completely to view. The sides of the panels were usually set off with figures of some description. The strictly classical character of the illustration is significant, and stamps it as the result of much study on the part of the original inventor. We have evidence that the *pilentum* was often extravagantly finished, the pillars supporting the top being



THE PILENTUM.

rich in material as well as workmanship, in some instances the cushions and other interior furniture being made from wool or silk according to the purses of the owners. According to Servius, the bodies of these vehicles were generally painted red in his time, but, earlier, sky-blue prevailed.

We have elsewhere observed that the ancient Romans had carriages adapted to different purposes. The *pilentum* was fitted for showing off the rich costumes of the Roman matrons on all public occasions, and for the exhibit of the votive offerings consecrated to the heathen deities, and therefore for a long time was the only vehicle allowed in religious processions, — a particular mark of distinction from the Senate to those who had sacrificed their jewels and ornaments for the public good. The *pilentum* was frequently used to convey the vestals

to the temple, for Prudentius says, "Meanwhile the celibate priestess, as in public pomps, rides in the pilentum, blowing the sacred fire and showing herself to the city." A passage in Macrobius confirms this opinion. The pilentum seems to have been employed extensively in traveling long distances, their lightness no doubt contributing to this end.

The *cisium*¹ was another, supposed to have been a still lighter vehicle, on two wheels, much used in carrying the mails from one town to another. Its very name would seem to indicate speed.² The drivers of the *cisium* were called *cisiarii*, and were often punished for driving too fast and ill-treating passengers, — worthy prototypes of our modern Jehus.

The annexed engraving is supposed to represent a *cisium*, and is copied from a Roman monumental column at Ingel, near Treves, in France. They are said to have had the wheels much larger than those

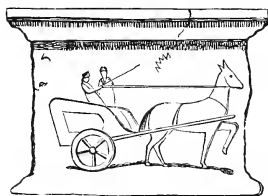

CISIUM.

of any other carriage in use among the Romans. Cicero states that messengers traveled in them fifty-six miles in ten hours, considered very quick time in those days. Ausonius, in speaking of a three-horse *cisium*, says it is so light and expeditious that "when only two traveled, the gentry could easily visit their neighbors at their villas in the country." In a speech

before the Roman Senate in defense of Roscio, it is stated that in ten hours of the night he flew fifty-six thousand steps *in cisiis*,³ not only mentioning the speed at which he traveled, but plainly showing that several carriages were employed between different posts; that no sooner was the traveler put down at one *cisiarii*, or stage-office, than the *cisiarius* was ready to forward him to the next without the least delay. As previously mentioned, the drivers were rather "fast boys," and among the Roman laws are found some severe penalties for their

¹ Some authors maintain that the name "*cisium*" is derived from the Latin word *cito*, quick; others assert that it received its name from *scissum*, cut, a hole being cut through the sides of the body.

² "Inde *cisio* celeriter ad urbem vectus domum venit, capite involuto." — CICERO, *Phil.*, II, 31.

³ "Decem horis nocturnis sex et quisquaginta millia passum *cisiis* pervolavit." — CICERO, *Rosc.*, *Am.*, 7.

punishment. They were not only reckless drivers, but very remiss in duty towards those who employed them. In traveling at night, as they frequently did, the Roman postilions very often upset the cisium in racing with other vehicles or in passing them on the road. Having higher wheels than other vehicles, it rendered them more liable to such accidents.

In the days of Julius Cæsar, the cisium, being the post-carriage of the Roman Empire, was by them introduced into Italy and Gaul after the conquest of those nations. Intercourse was kept up by using them between the chief stations and military camps, their light construction rendering them very efficient for that purpose. The Romans were noted for making good roads, being solid, level, and dry, and carried forward in as straight a line as possible, so as to economize in both time and distance. The highest elevations were selected as points of survey, from which the next post or station, often at considerable distance, might be seen. In order to obtain the earliest intelligence of what was passing in the provinces, Augustus established posts, consisting at first of young men stationed at moderate distances along the military roads, and afterwards of regular couriers with fast vehicles. Appian, says Curio, with Cæsar's letters, traveled three thousand three hundred stadia in three days. Tiberius Nero, according to Pliny, traveled, in three cisiums, one day and one night, two hundred miles to visit a sick brother.

A vehicle supposed to represent different varieties of the cisium is found on antique gems, often illustrative of mythology, or in honor of some noted personage. Our engraving is an example of this kind, in which deer are found, indicative of speed, to which generally two horses were attached, these to so light a carriage being quite sufficient, although Ausonius says the wealthy often had three and even four harnessed up, not because such were absolutely required to draw it, but for the sake of show. In those remote times almost every wealthy family had its special courier or messenger, generally selected from their slaves or other dependants, who carried their messages either on horseback or in a cisium, so as to be independent of any public institution. The public couriers had to obtain a license from the government, which allowed them to use the imperial horses and



CISIUM.

vehicles; for without such special permission no one could, without incurring a penalty, interfere with the business of the *cisiarii*. As a large business was transacted by these *cisiarii*, it involved considerable capital, and therefore contractors were selected of known responsibility and approved business habits for each station, bound, under certain rules, to supply vehicles and animals to travelers, also to carry packages and letters. To protect these from the damaging effects of the weather, they were enclosed in the box of the cisium.

Ordinarily, the body of the cisium was fixed to the frame or shafts, while in the better kind it was sometimes suspended on straps or braces, as with more modern nations previous to the invention of springs. Cicero says it was possible to write in them.¹ Being closed behind, entrance was had from the front, the driver sitting in the vehicle except in special cases, when more than two horses were used, when, that the wealthy or aristocratic might not be disgraced by sitting beside a menial, the driver was mounted on a third horse, all abreast, holding the pole horses by reins. The wealthy Romans were not indifferent to comfort in their carriages, so they had them provided with cushions; but it does not appear that the cisiums were in general use by the ladies, although there was an exception to this rule, as will be observed, for besides being too open and exposed for the gentler sex, no doubt prejudice had much to do in discountenancing the practice, as the cisium was known as "the gallant's carriage." The young and gay Romans frequently employed them in their nocturnal expeditions, disguising themselves by putting on a *pileus*, or cap, similar to that worn by the driver. Cicero, in speaking of Marc Antony, the victim of Cleopatra's charms, says that on one occasion



MONACHUS.

"he drank until evening, and then drove quickly in a cisium to the city with his head covered," that he might not be recognized by the public.

Under the name of *monachus* there seems to have existed, among both Greeks and Romans, a very light two-wheeled vehicle, not much unlike the cisium in the form of the body. Our engraving is copied from Montfaucon's work, and is there accompanied by a Latin inscription, which goes to prove

¹ "Quaedam sunt, quae possis et in cisio scribere." — *Epist.* 72.

that it was sculptured on a slab in memory of a distinguished female, the wife of some wealthy citizen of Rome. It reads thus, "*D. M. Nocturnio nocturniano Merocila conjux posuit,*" and is accompanied by a portrait of a lady, doubtless intended to represent the wife. The vehicle is rounding at the back and very low in front, so as to furnish easy access to the passengers, who appear to have been principally females. It was evidently the pony phaeton of the Roman ladies.

The *birotum* was a small, two-wheeled vehicle, drawn by one horse, with a comfortable, leather-covered seat, and an arrangement behind for carrying luggage. It was of late origin and contrived for rapid transit. It was never introduced in private use, but kept at the post-stations in the time of Constantine, where the traveler could choose between this vehicle or a horse. As it was intended merely for rapid transit, the law forbade to carry more than six hundred pounds of luggage on it. It was often used by the government for their couriers.

ROMAN POST BIROTUM.

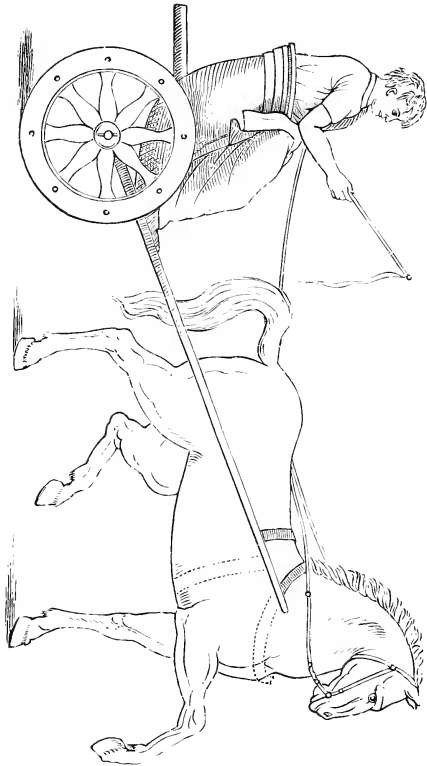

There is no Roman vehicle about which there has been more dispute than the *arcera*. Adams, in his "Roman Antiquities," informs us that it was a covered wagon or cart, used for carrying the old and infirm

of meaner rank, and the manner in which this is told leads us to infer that he knew nothing about it. Beckman, in the "History of Inventions," says that "the earliest Roman vehicle on record is the *arcera*,¹ a kind of covered cart, of which mention was made in the Twelve Tables." Ginzrot, who gives us the copy for our picture, describes it,

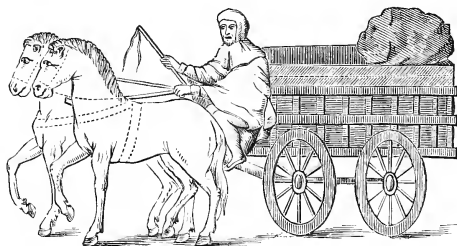

ARCERA.

on what authority we cannot tell, as a four-wheeled vehicle, and says, "It was a sort of covered carriage, consisting of a long, coffin-like box, softly lined, in which to transport sick people." The bundle on top of the box, he tells us, "is food for the horses,"—information about which hangs some doubt. If he is right in the selection of his illustration, it must have been a sort of peddler's wagon, with an enclosed box for the transportation of merchandise. Beckman further says that the *arcera* was used for sick and infirm persons, but if such was the case it must have been a different vehicle from the one here shown. To crown all, some speculators say that "it *appears* to have been employed much earlier than the more luxurious *lectica*, and by it to have been brought into disuse."

The *carrus*² was the name of a cart or wain that seems to have been, under different forms, very much in use among both Romans and Gauls for the conveyance of heavy baggage. It was unsuited for carrying passengers. The term "*carrus*," some writers tell us, is not a Latin word, and would have us believe that the vehicle under this

¹ The name is said to have come from *arcus*, a roof, the top of the box being roof-shaped, or arched.

² *Carrus* is a word of Gallic origin, which Ginzrot says should read "*karr* or *karre*," inasmuch as the Swiss of the present day, descendants of the ancient Helvetians, name their wagons *karren*. The French, in some sections of their country, as in Burgundy and the "Gold Coast," where the primitive wagon of the Gallicans (called *char-à-banc*, a wagon provided with benches) has been retained, still name their wagons *chariot-car*, hence we find *cabriolet*, *cart*, *chariot*, etc. With the Teutons a light sporting carriage was called a *karrette*, and a show or parade wagon, *karratsch*. In Teutonic ballads of the

name is not exactly of Roman invention, although much in use in the army in Gaul under Julius Caesar, who, in his "Commentaries," calls them "plaustrî," and employed them in bringing up the rear-guard and military equipments of the army. Hence, they merely answered the purpose of munition or baggage wagons to the forces (army), and were designated by Caesar as *impedimenta* or hindrances, in which term is included both

the vehicle and the baggage. When Caesar made allusion to the train of women and children in the wake of "the *impedimenta*," he invariably mentioned the *rheda* in connection with the cart. This *rheda*, as will be hereafter shown, was quite a different sort of carriage. In it the "bar-

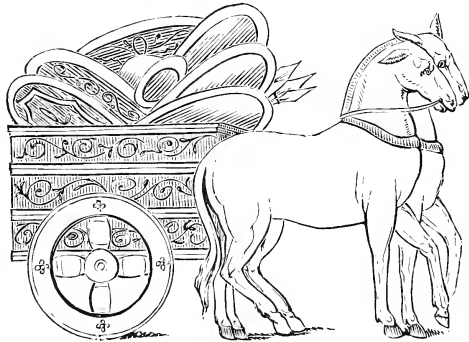

THE CARRUS.

barbarians," under which term the Romans included all foreigners, took their wives and children with them to the battle-field, these always following the army in the *rhedas*, which at night were so placed as to afford them the protection of a redoubt, under the impression that, by having their loved ones along, the soldiers would be incited to fresh deeds of valor.

Our illustration is taken from the Pillar of Marcus Aurelius at Rome. The wheels, which are rather low, have in each but four spokes, and the box or body, of a parallelogram shape, appears to have been paneled with boards, and ornamented with scroll-work

chivalrous age we frequently meet with the word. Nowadays (1817) an old-fashioned lumbering vehicle is derisively styled an old *karrette*. In the Breton language the carrus is called *kar*, and in the Chaldaic tongue, *carron*. With the English people, a *karren* is a cart or wagon. Ginzrot's *Wagen und Fahrwerke*, Vol. I, ch. xvi. Caesar, according to Latin custom, retained the word, giving it a Roman termination. Fabricius, in his *Bibliographia Antiquaria*, ridiculously traces the origin of the term "carrus" to "*Quadrus, quasi a quatuor rotis.*"

painted thereon. The inside space is filled with bucklers and various warlike armor. This *carrus* is drawn by mules.

The Helvetians, according to Cæsar, on setting out on their expedition against the Gauls, provided among other things, by purchase, "a great number of *carræ*."¹ These were designed for carrying heavy burdens, as is evident from the construction. From this, however, it is not to be inferred that the Roman non-combatants were not allowed to avail themselves of this vehicle for the conveyance of their ammunition and burdens, only that they were more generally used abroad than among the Romans, with whom the *plaustrum* was more in favor.

A number of words, such as *carruca*, *carrheda* or *carrete*, *carpentum*, and others probably took their origin from *carrus*; and although in the course of time the shape differed somewhat from that of the *carrus*, yet they no doubt resembled it at first more closely. In the monastic archives of the "Middle Latin Times," the words *carrus funarius* are frequently found, meaning a low sort of bricklayer's cart. In quoting the word *carrus*, Matthew Paris says, "None of our *balliren* nor *vice-*

¹ "Jumentorum et carrorum quam maximum numerum cœmere."—*De Bello Gallico*, B. I, ch. 3. Some modern commentators, among whom is Anthon, translate *carrorum* "wagons," but gives us two forms of the nominative, *carrus* and *carrum*, admitting that the word is of Celtic origin, the neuter *carrum* prevailing in its later Latinity. He adds, "The word . . . denotes a kind of four-wheeled wagon."—*Notes to Anthon's Cæsar, in loc.* Ginzrot, to whom we are indebted for much information, says, that "the *carrus* was not a four-wheeled carriage, as some are inclined to believe, may be gleaned from the *Codex Theodosius de Cursu Publico*, reading thus: The two-wheeled cart, the *birota*, must not be laden with over six hundred pounds' weight; and further (*Leg. 47*), where it is enjoined to load the body of the *rheda* with a thousand pounds, and the *carrus* with six hundred pounds, no more nor less. We should indeed judge rashly were we to affirm that for carrying six hundred, more than two beasts of burden and one four-wheeled wagon were required. Three hundred pounds is a light load for a single ox or mule to pull, since any beast of burden may conveniently carry that much on his back. Carts were not only brought into requisition in war times, but likewise in times of peace, on the roads, in the public service, to bring up ammunition for the troops, or the baggage of certain functionaries who were entitled to a car like the above. In order, however, to prevent an abuse on the part of this immunity to the detriment of the indigent peasantry (they generally overloaded them), the weight of the load which they were permitted to take with them was fixed by statute, — a step resulting in the prevention of arbitrary measures on the part of those favored wayfarers, and in enabling the beasts of burden to get along without injury to themselves on the very worst kind of roads."—GINZROT'S *Wagen und Fahrwerke*, Vol. I, ch. xvi.

comes, or any one else shall employ the *carreta* for riding purposes"; and in the Magna Charta of King John, Art. 20, a passage in Latin reads thus: "*Ne vicecome vel ballirus regis vel aliquis alius capiat equos vel carrettas alicujus libera hominis pro cariagio faciendo, nisi volutate ipsius.*"

These *carrī* were perfectly well adapted to the narrow defiles of the country (now Switzerland) inhabited by the Helvetians, for which very reason they were provided with a narrow track or gage to enable them to pass with more safety the numerous mountain-passes, for it is evidently much easier to construct vehicles to suit the condition of the roads than it is to make the latter conform to the construction of the vehicles. Julius Cæsar often speaks of those "*viis angustis*," or narrow passes, where one cart could scarcely pass another, — a fact which is more minutely illustrated in his "*De Bello Gallico*," B. I, ch. vi, and in his "*De Bello Hispan.*," ch. vi, showing that a wide track would have been not inconvenient only, but quite impracticable. Cæsar says, in one place we have referred to, that "the road leading through the country of the Sequani, betwixt Mount Jura and the river Rhone, was so narrow and difficult to travel that scarcely a single *carrus* was able to pass over it."¹

The engraving represents a *carrus* laden with barrels lying on cross-beams or rafters, the wheels having six spokes in them. This vehicle is drawn by a yoke of oxen, the yoke itself being ornamented at the ends with carved imitation of a lion's head. A well-preserved figure of this cart is found on the Pillar of Trajan. Such were probably employed in carrying liquids on war-like expeditions. It is well known that wine and vinegar, so eminently wholesome in hot climates, were served out to the Roman sol-

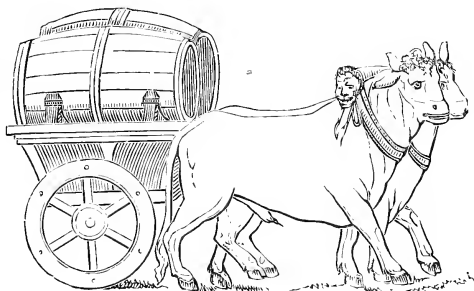

CARRUS FOR LIQUIDS.

¹ Julius Cæsar's *Commentarii De Bello Gallico*, B. I, ch. vi.

diers, along with oil, to season their vegetables. Sometimes, as is seen on the Pillar of Marcus Aurelius, the body of the carrus was formed of plank and filled with barrels, with leather pipes contrived for drawing off the liquids, and these were so skillfully sewed that no liquid ever oozed through the sides thereof.

The carrus differed from the plaustrum in the following particulars: the box or form could not be removed, as in the former case, but was fastened upon the axle-tree; it lacked the broad flooring of planks or boards, which served as a receptacle for certain commodities when the sides were removed; the wheels were higher, as with the common Roman plaustrum; these were, moreover, spoked, and not solid like the *tympana*, which were impracticable in mountainous regions. If this were not so, says a modern writer, Caesar would certainly mention the plaustrum now and then, or the pauc-wheel; but nowhere in his work on the War in Gaul do we meet with any allusion to this subject.

Another vehicle was by the Romans called the *carrus clabularius*, a stave-wagon, as shown in the annexed illustration, intended for the transportation of merchandise in commercial towns. This, for the age,

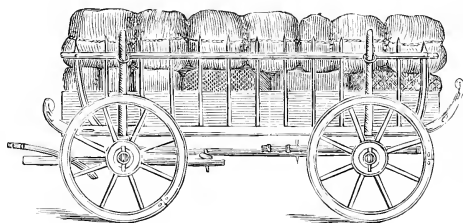

CARRUS CLABULARIUS.

was quite an ingenious piece of mechanism, and would not be despised were it again adopted for business purposes in our time. Many points in this vehicle are worthy of note. The body is admirably contrived

for showing off the contents, which in this instance consist of bale-goods. An arrangement by which the reach was lengthened or shortened as occasion demanded is another feature of interest. Here, too, is seen the sway-bar, so important in a business wagon, and in addition to all these, wheels of equal size front and rear, showing that the Romans were far in advance of our modern Adamases, who discourse eloquently for equirovals in every kind of four-wheeled vehicle.

Plaustrum was the name given among the Romans to all kinds of farming carts and wagons, whether on two or four wheels. Strictly

speaking, however, it applied more particularly to open carts, consisting simply of pole and axle. At both ends of the latter revolved *tympanis*, or pauc-wheels,¹ made of solid wood, as seen in the next engraving. Some tell us that the axle in these vehicles revolved with the wheels, and that these axles returned in check-pieces or sockets, called *arbusculæ*. On inspecting the designs extant, we find many wheels fastened on the axle-trees by linchpins, and some few without. We conclude from this circumstance that both modes — revolving *on* the axle-tree and *with* it — were in practice. The entire construction appears to have been of the most primitive kind.²

On the Triumphal Arch of Lucius Sept. Severus, at Rome, several carts are represented with tympanum wheels, some of which are drawn by mules, others by horses. Curtius calls this vehicle *vulgatum usu*, or the commonly used plaustrum, and Valerius Maximus the *plaustrum sordidum* (dirty plaustrum), for the plaustrum³ was used for carting manure, stone, wood, hay, oats, and many other things, without putting them in a box, by simply filling a basket, which was then set on a board or platform. For this reason it was somewhat dangerous to walk beside a loaded plaustrum on rough roads. Hence Juvenal satirically says, "If the plaustrum that carries the Ligurian stone upsets and throws a mountain of stones over the crowd, what remains of man to be seen?" To avoid accident, the Emperor Adrian prohibited the driving of overloaded plaustra through the streets of the city.

Our picture, taken from a bass-relief in Rome by Luc. Petus, appears to represent a hay-cart, the hay being stored in a sort of basket or crate of splints interwoven with each other. This box was set on the frame answering for the body, so as to be easily removed when required. The wheels were solid, and strengthened by strips

¹ "Hinc radios trivère rotis, hinc tympana plaustris agricolæ." — VIRGIL, *Geor.*, II, 444. This wheel was called *tympanum* because it resembled a drum. See p. 19, note.

² Carts of a very primitive kind are still found in Italy, Spain, and Portugal. The axles of these carts being seldom greased, the squeaking noise they produce can be heard for a mile away. Six or more oxen are often required to start them, where two would do the same work were they properly built. A modern author declares that "prejudice overthrows good sense in such countries." The noise created by these squeaking machines is made the subject of satire in the works of Horace. (*Sat.*, VI.)

³ Among the rustic Sabines, the *au* was pronounced *o*, as in *plostrum* for *plaustrum*, which Mestrius Florus, on a certain occasion, endeavored to correct in the pronunciation of Vitellius. "Mestrium Florum consularem, admonitus ab eo *plaustra* potius quam *plostra* dicenda, die postero *Flaurum* salutavit." — SUET., in *Vesp.*, ch. xxii.

of boards, which were sometimes shod with iron strakes, called *cantlus*; and although the vehicle appears to have been a clumsily constructed

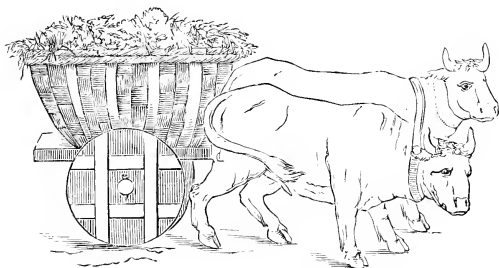

HAY-PLAISTRUM.

machine, yet it was often used for hunting purposes, the arms, provisions, and equipments of the hunter, as well as the game, being carried thereon. When baskets were used, they were secured to

the platform either by cords or between four stakes, although these last are not shown in our illustration. These were generally drawn by oxen, as other carts, although occasionally mules were employed.

The engraving, also copied by Luc. Petus, in Rome, from a bass-relief, represents a wine-cart, on the platform of which stands a basket; inside of this is placed a rick, on which is supported the bag, made of hide, to hold the wine and olive oil carried therein. These were commonly goat-skins, with the hair side turned in. The rick or wooden ladder was designed to support the bag in transportation, and the basket or other vessel to catch and hold the liquid in case the bag should accidentally burst. The dog, whose office was to drive, was considered indispensable when oxen were employed.

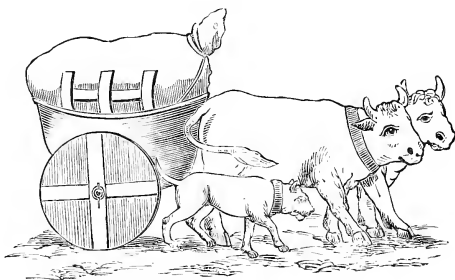

ROMAN WINE-CART.

One of the uses of the plaustrum in war was the removal of the wounded to a place of safety. Caesar employed them in carrying his wounded soldiers to Adrumentum after battle. They were likewise

employed in removing the dead in the time of a fearful pestilence that prevailed in Rome under the rule of Marcus Aurelius. Great numbers of these vehicles were employed at funerals, as we learn from Horace,¹ where "funeral-horns and trumpets" blown by the musicians mounted on the *plaustra* created much confusion. Each funeral was attended, sometimes by as many as seventy *plaustra*, carrying offerings and other things necessary in such ceremonies where the bodies were burnt, such as small animals, tapestry, ornaments for the funeral pile, the salves, fumigating articles, vases, etc.²

The *plaustrum*, common as it was, was nevertheless sometimes used to carry passengers. Livy says that when Rome was taken by the Gauls, Lucius Albinus fled from the city with his wife and children in one of these vehicles. The vestal virgins on this occasion likewise, after hiding a portion of the sacred vessels, fled across the Sublician bridge to the Janiculum, meeting in their flight the Roman named above, who had preceded them, every non-combatant leaving the city. But this L. Albinus, although a common citizen, had a proper estimate of the difference between secular and sacred things, and thought it impious that he and his family should be seen riding in a vehicle, while priests and priestesses walked, carrying sacred things. He therefore ordered his wife and children to get out, and allowed the virgins to sit in the *plaustrum* while he drove them to Cære, their place of destination.³ Livy says expressly *in* the *plaustrum*, not *on*, evidently showing that this vehicle had several seats, from which we conclude that his wife and children could all sit in it; and as it was not permitted L. Albinus to be seated alongside of the virgins, it follows that he was obliged to walk and drive.

There was another *plaustrum* covered all around with untanned ox-

¹ "He with his loud voice would have surpassed in crying the noise of two hundred *plaustra* meeting at these funerals in the market, yea, their funeral-horns and trumpets." — HORACE, *Sat.*, VI. "The notorious Messalina, wife of Claudius, in his absence at Ostia, having allied herself to Silius in marriage, when afterwards the emperor ordered her apprehension, after walking the entire length of the city, got into a cart employed in carrying refuse from the gardens, making her way to Ostia, where she was dispatched unpitied in disgrace." — TACITUS, *Ann.*, XII, 32.

² The body of the deceased was laid out in the best robe, and carried to the funeral pile or tomb to the sound of music. This ancient pagan practice appears to be imitated by the Irish in our time.

³ Livy's *Hist. Rome*, B. V, ch. xl.

hides. Such a vehicle is supposed to have been employed by Lucius Turinus to drive the vestals to the capitol. Valerius Maximus¹ tells us that this rural and nasty (*sordidum*) *plaustrum*, which was just of the right width, became in consequence as much celebrated, perhaps more, than the triumphal car. Other proofs might be adduced to the same import.²

The Romans had besides a *plaustrum* on four wheels (*plaustra majora*), which carried a large number of people. Sometimes these passengers were not of the quietest class, according to Valerius Maximus, who says, "The flute-players, who had emigrated to Tibur, and refused to return to Rome, were brought back to the city in the *plaustra* when wine and the want of sleep had made them intoxicated."³ This seems to have been a covered *plaustrum*, for Plutarch distinctly says, "He persuaded the flute-players to mount a *plaustrum covered all around with hides.*"⁴ This of course is understood to apply to the platform or frame, and not to a top or covering. History tells us that the Scythians and other nomadic people used a kind of *plaustrum* covered over with hides,⁵ but the Romans did not imitate this, as elsewhere seen.

Plostellum is the diminutive in Latin of *plaustrum*, and represents a little wain or cart, with which children amused themselves in ancient times, as appears from Roman writers.⁶ The engraving represents a wain of this kind, drawn by two goats, attended by a laughing boy, doubtless much happier than Caesar amid all his conquests. In this instance the basket is loaded with grapes, — a practice, let us fondly hope, which was not very often employed, on the score of morals. We shall meet with this vehicle again in another shape.

Another vehicle, known as the *curriculus*, diminutive of *currus*, was likewise used as a plaything for the younger Romans. A representation of this four-wheeled machine is shown in the engraving, drawn by a single pony. The body (box) seems to have been of very simple construction, evidently formed of boards set off with moldings. The



POSTELLUM.

¹ Valerius Maximus, B. I.

² Quintus Curtius, B. V, ch. xii.

³ Valerius Maximus, B. II.

⁴ Plutarch, *Questii Rom.*

⁵ See the illustration, "Scythian House on Wheels," Chapter VII, *ultra*.

⁶ "Eo missa plaustra jumentaue alia." — LIVY.

dog accompanying it is apparently in accord with his juvenile masters, and all well pleased with the journey they are undertaking.

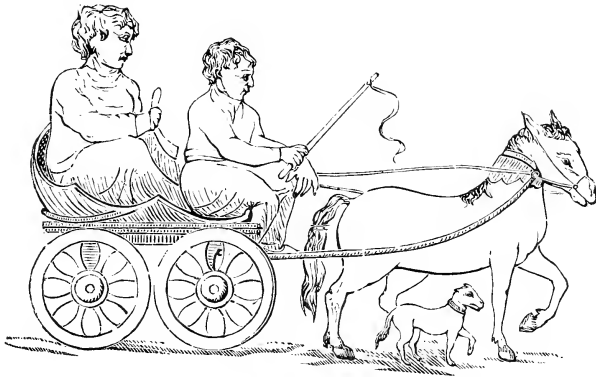

THE CURRICULUS.

The *pegma* has been by a modern writer, we think without sufficient authority, classed among Roman vehicles. It was probably nothing more than an improvised triumphal car for public pageants or theatrical displays. Pliny mentions these machines by saying, "*Caius princeps in circo pegma duxit, in quo fuere argenti pondo cxxiii.*"¹

The *currus*, or chariot, as among other contemporary nations, was a very important vehicle with the Romans, but differing materially from the arma of the Greeks. As a warlike instrument it was in very little repute, in fact was held in contempt by the soldiery when opposed to them in the ranks of an enemy, even when armed with scythes. At the battle of Thurium, where Sylla defeated Archelaus, one of the generals of Mithridates, the soldiers in the Roman army feared them so little that after the first onset, in which no injury was done (as though they had merely been interested spectators in a chariot-race), they held them in such derision that they cried out lustily for the enemy to send on more.² From a passage in Caesar's "Commentaries on the War in Gaul," we infer that war-chariots were a novelty to his

¹ Pliny, XXXIII, xvi.

² Livy says the soldiers on this occasion opened their ranks and let the chariots pass through, thus evading all danger.

army, and Livy tells us that, on the occasion referred to, "the enemy, mounted on chariots and cars, made towards them with such a terrible noise, from the tramping of the horses and the rolling of the wheels, as affrighted the horses of the Romans, unaccustomed to such operations."¹ Indeed, a war-chariot taken in Britain was afterwards exhibited in a triumphal procession at Rome as a great curiosity.

Although war-chariots figure more frequently in the works of the Latin writers than they do in their armies, yet we must not therefore necessarily conclude that chariots were unknown to the people of that nation. In the triumphal processions of the victors they occupied a very prominent place. One lasting for the space of three days, given to Paullus Æmilius in honor of his victories over Perseus, showed over two hundred and fifty chariots and a great number of wagons carrying the spoils taken from the Macedonians in battle. The whole story is told from Plutarch further on in this chapter. In Kenneth's "Roman Antiquities" will be found a plate representing this pageant, whereon are depicted several varieties of the Roman chariot. Chariots were distinguished as *sejuges*, *septemjuges*, *decemjuges*, etc., according to the number of horses attached to them; and also known as *bigas*, *rhedas*, and *currus*, according to the uses to which they were assigned. They seldom carried more than two persons, both standing, and were always drawn with the horses harnessed abreast.²

The chariot-races among the Romans, as with the Grecians, were matters of deep interest. The chariots used were generally light, two-

¹ "Genus hoc est ex essedis pugnæ [inter Britanniam]: primo per omnes partes perequitant, et tela conjiiciunt, atque ipso terrore equorum, et strepitu rotarum, ordines plerumque perturbant; et, cum se inter equitum turmas insinnaverint, ex essedis desiliunt, et pedibus proeliantur. Aurigæ interim paulatim ex prælio excedunt, atque ita curru se collocant, ut, si illi a multitudine hostium premantur, expeditum ad suos receptum habeant." — C. JULII CÆSARIS, *Commentarii de Bello Gallico*, B. IV, ch. 33.

² Although we nowhere read that the Romans used chariots in battle, yet it is on record that Domitian erected many magnificent gates and arches, which were surmounted by figures of chariots drawn by four horses, and other triumphal monuments in different quarters of the city, so that a wag, in Greek, wrote on one of the arches, *Ἀπκεῖ*, "It is enough." "Janos acusque cum quadrigis et insignibus triumphorum per regiones nrbis, tantos ac tot exstruxit: ut euidam græce inscriptum sit arcui *Ἀρκεῖ*." — SÆT. in *Domit.*, ch. 13. According to Apuleius, Æmilianus Strabo, the Roman proconsul to Carthage, "had everywhere in that city erected by the people equestrian statues, with chariots of four and six horses." — *Florida*, xvi.

wheeled bigas and quadrigas, made narrow, with just sufficient room or space for the charioteer (*auriga*) to stand in, and which, never being designed for any other purpose, were built so very light that a man could easily carry one on his shoulders. The body was commonly basket or wicker-work, or else consisted of a bottom frame, with an iron railing all around covered with leather, the iron railing reaching as high as the knees of the driver, whose movements had to be free and unimpeded by anything on the sides. The body was left untrimmed, except in front, where the knees of the driver touched it. All the bodies of such chariots as had railings had the lower portions stuffed, and the top edges and sides of the railings puffed (trimmed) with leather, to secure the driver against injury, should such arise from sudden joltings or other causes. The rail (*antyx*) was looked upon by ancient authors as a very important part of a body, who therefore taught that it should be made much thicker than the sides of the body to which it was attached. This, for greater security, was often supplied with plates of ivory, bronze, and sometimes the more precious metals. Among the Romans the axle-tree (*axis*) is supposed to have been made of beech, ilex, ash, or elm.¹

An ancient Roman chariot, in bronze, is preserved in the Vatican Museum at Rome, from which, among other things, we find that the axle was fastened to the body by bolts with nuts, as with us, except that they are used in connection with scrolls of an ornamental pattern, placed between the body and wheels. Here we find the wheel turned on the axle, as among us. This wheel had a hub (*modiolus*) of some tough wood, and was banded with iron. This hub seems to be extravagantly long, after the fashion of olden times. The spokes (*radii*) were generally either six or eight in number, very rarely ten. The felloes or rim (*apsis*) was formed of four pieces, but whether bent or "worked out" by the Roman mechanic is an unsettled question, although most probably worked out. The tire (*canthus*) was put on in pieces or sections of the

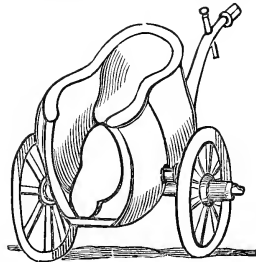

ROMAN CHARIOT.

¹ See Pliny's *Nat. Hist.*, B. XVI, 84, etc.

“strake” kind, when made of metal. This undoubtedly was often made out of wooden strips bent to the shape of the rim, like our half-rims, answering the same purpose as the contrivance to the Egyptian wheel on page 60. Poetical license, as has been seen in these pages, has often manufactured tires out of the precious metals,¹ but such must have been *too precious* for practical use. The pole (*pertica*) was usually secured at the back end to the axle-tree. Homer says that Juno’s chariot had a silver pole, but those of mortals, we opine, were made simply of wood, what kind of wood we are not informed.

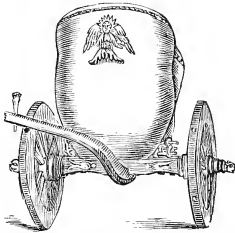

FRONT VIEW OF ROMAN CHARIOT.

The yoke (*jugum*) was attached to the necks of the two central horses when more than two were harnessed to a chariot (a quadriga, for instance), as was often done. We would remark, *en passant*, that the *jugum* among the Romans was a significant emblem of complete humiliation. Whenever they obtained a victory over an enemy, they forced the conquered to pass under it, in token of absolute subjection. Several instances of this will be found in the Commentaries of Caesar and other Latin authors, where the subdued were forced to undergo this humiliating ordeal. The unfortunate enemies of Rome were supposed, in this degrading process, to have been as effectually *yoked* to the Roman Republic as were their beasts of burden to plows or chariots. When these afterwards revolted, they were said *to have shaken off the yoke*, — by this act proving that men have not always been as completely subjected as have been the lower animals.

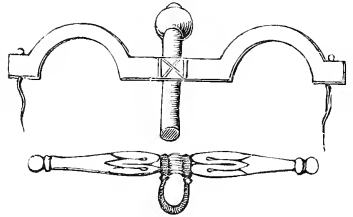

ROMAN YOKES.

The wheels of the bigas² — two-horse chariots — for racing among

¹ “Aurea summæ curvatura rotæ.” — OVID, *Met.*, II, 108.

² The Romans called such coins as were stamped with the figure of a chariot drawn by two horses, *bigati*; those with four horses, *quadrigati*. Some of these earlier coinages, being much purer, were highly popular in the German provinces. — TACIT., *Ger.*, ch. vi.

the Romans were made very low, and, like the axle-trees and poles, made of wood, and slightly ironed, whilst the Grecian bigas had both axles and wheels made of iron or brass, all carefully constructed and extremely light. In order to avoid upsetting, these light vehicles had axles very long, making a broad track. There was no profusion or rich ornamentation on the plainer or common kind; but such bigas as were used in the circus by emperors and distinguished princes were remarkable for artistic workmanship and splendor, and were covered over with gold, silver, ivory, and an infinity of precious stones. A

chariot of this kind is supposed to be shown in the annexed engraving. This vehicle has but six spokes in the wheel, beautifully rounded and formed. The raves have had considerable artistic study ex-

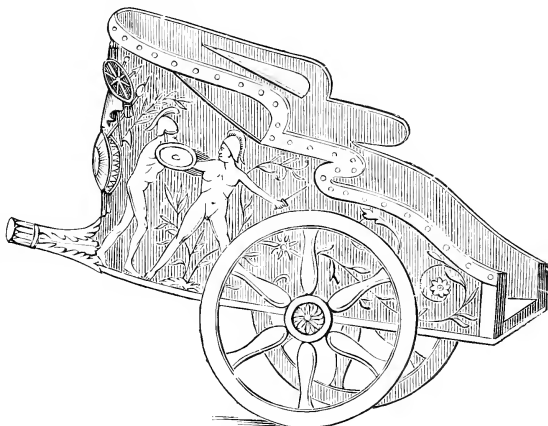

CIRCUS CHARIOT.

ended thereon. The gladiatorial scene on the panel, with the accompanying scroll-work, shows that it represents a chariot of no common build and of no mean design.

The races in the Circus Maximus¹ at Rome in different seasons of the

¹ The Circus Maximus — so called because it was the largest in Rome — was rudely constructed of timber by Lucius Tarquinius Priscus (Y. R. 138), and subsequently enlarged and improved with the growing fortunes of the Republic, until under the Emperors it became a most superb edifice. Julius Cæsar extended and surrounded it with a canal ten feet deep and as many broad, to protect the spectators against danger from the chariots during the races. Claudius rebuilt the *carceres* with marble, and gilded the *mete*. This vast center of attraction, in the games of which religion, politics, and amusement were combined, was, according to Pliny, three stadia, or six hundred and twenty-five feet long, and over two hundred feet broad, holding two hundred

year were divided into four factions: the Prasina, Russata, Alba or Albata, and the Veneta. The first (spring) was represented by green colors, the second (summer) by red, the third (autumn) by white, and the fourth (winter) by sky-blue. Green was the most taking color under the chief emperors.¹ To these four, Domitian afterwards added golden and purple colors.² After his death these were abolished, some pretending that there was too much confusion where so many chariots racing at one time turned around the *meta*, or turning-point.

According to a passage in Virgil,³ there were anciently twenty-five matches a day, four chariots in each match, so as to make one hundred in all. The last course (*missus*) was run at the expense of the people, who made up a purse to defray the costs. This was called *ærarius*.

On the twenty-fourth day of March, the day appointed for the races, the peasants invoked the gods to give victory to the green, believing then a fertile year would ensue. Sailors in their turn prayed for a victory for the blue, betokening thereby successful and prosperous navigation. The overseers of the factions were called *domoni*. Originally the Romans at the races employed only slaves, "freedmen," or servants, but sometimes strangers, relying upon the speed and superiority of their horses, challenged others for the race. After a short time had elapsed, these plays increased so much in favor with the public that the noblest youths and most distinguished personages, yea, emperors and senators, were not ashamed to appear in the circus.⁴ So it is said of Caligula, Nero, Vitellius, Verus, Commodus, Caracalla,

and sixty thousand spectators, who came to see the horses and boxers of the Etrurians, who were the chief performers. So much was the edifice crowded that the satirist tells us, "*Totam hodie Roman circus capit.*" (Juv., *Sat.*, XI, 195.) The area of the Circus Maximus occupied the hollow between the Palatine and Aventine Hills, so that it was overlooked by the imperial palace, from which the Emperors had so full a view of it that they could from that height give the signals for commencing the races. But few fragments of the structure now remain.

¹ Some writers affirm that having adopted the races of the Greeks, the Romans added thereto the red and white factions, calling the red, *factio rosea, rubea, nissata, et cœcina*; the white, (*alba*) *candida*; the green, *prasina*; and the blue, *veneta*.

² "Duas Circensibus gregum factiones aurati purpureique panni ad quatuor pristinas addidit." — Suet. in *Domit.*, ch. 7.

³ "Centum quadrijugos agitabo ad flumina currus." — VIRGIL'S *Geor.*, B. III, v. 18.

⁴ "Circensibus, spatio circi ab utraque parte producto, et in gyrum Euripo addito, quadrigas bigasque, et equos desultorios agitaverunt nobilissimi juvenes." — Suet. in *C. J. Cæsaris*, ch. 39.

Heliogabalus, and many other emperors. These and other notables openly declared in favor of the one or other faction, but the people often applauded their favorite in an opposite faction, and this sometimes caused bloodshed in the circus. Caligula one day became so much incensed with the people for opposing the green faction, which he favored, that he ordered his body-guard to use their arms against the assembly;¹ and the Emperor Vitellius considered it a crime against the state not to applaud the blue, which he was in favor of.

Nero ordained public overseers, and a number of detectives and spies, whose business it was to scan the countenances of the spectators, and if any one happened to look angry or to fall asleep, it was certain death to him. A person once in the circus was not allowed to leave under any pretense, but was obliged to remain as long as the races continued, sometimes to the latest hour of the night. Vespasian,



ROMAN COLISEUM AND ITS SURROUNDINGS.

afterwards emperor himself, once fell asleep in the circus, and was so roughly used in consequence by Phæbus, a freedman of Nero, that he only escaped death by incessant pleadings and prayers, in connection with the good offices of his friends, which induced the servant not to

¹ Suet. in *Cal.*, ch. 55. So excessively fond was he of some charioteers whose colors were green, that he supped for some time in the stable where they kept their horses. At a certain revel he presented one Cythicus, a driver of a chariot, with two millions of sesterces.

report him. Suetonius declares that women were frequently confined in the circus, and others were suffocated by the crowd; unable to endure the fatigue any longer; many spectators feigned death, that they might be taken outside. Still, the circus was always crowded to excess. Roman citizens on such occasions forgot their own and state affairs, remaining for days in the circus, not caring for anything besides. He tells us that on one occasion when a famine prevailed, so distressing that the people went every day to the sea-shore, expecting the arrival of a ship with provisions, they discovered, at last, a large ship, completely rigged, approach. Every one rejoiced, thanking the gods; but the ship proved to be laden with fine sand from the river Nile, designed for sprinkling over the race-course. Gladiators, being rubbed all over with oil, used to throw this sand at each other, that they might the better hold an adversary. Domitian is said to have often prolonged the races to a late hour of the night, accompanied with torchlight illuminations. The most terrible storms of rain could not force him from his seat at the circus. He only changed his overcoat as often as it was soaked through with water.

Under the government of the emperors, "the Roman people seem to have been more fond of the chariot-races than any other division of the games. For this reason Mæcenas advises Augustus not to allow any city but Rome (where the populace were to be kept together in good humor at all events) to give chariot-races without the other usual gymnastic exercises, in order to prevent useless expenses, factious riotings in favor of particular charioteers, and that there might be no want of the best horses for the army."¹

Nero himself acted the part of charioteer in the circus, driving four horses,² and at the Olympic games, ten. On his arrival at Naples from Greece, he entered Rome in a chariot drawn by white horses through a breach in the walls, after the Grecian manner.³ He is said

¹ *Archæologia*, Vol. III, p. 171. "When, however, he drove four horses to a chariot in public, a piece of ground in the valley near the Vatican was enclosed that he might drive without being exposed to a promiscuous crowd of spectators." — TACITUS, *Ann.*, B. XIV, ch. 14.

² "Aurigavit quoque plurisariam, Olympiis vero etiam decemjugem." — Suet. in *Nero*, ch. 24. "By driving in the circus he demeaned himself, however." — TACITUS, B. XV, ch. 44.

³ "Reversus e Græcia Neapolim, quod in ea primum artem protulerat, albis equis introiit, disjecta parte muri, ut mos hierouicarum est." — Suet. in *Nero*, ch. 25.

never to have traveled with less than one thousand chariots, the mules of which were shod with silver.¹

The life of the charioteer was viewed as mean and low. Vitellius, who spent much of his early life in the business in Nero's reign, and was one of his cronies, built a set of stables after he came into power, at the public cost, for the accommodation of charioteers, and besides kept a constant show of gladiators and wild beasts in the circus. Prominent in the crowd were this class of people, who went out of the city to meet Vitellius on his entrance from the provinces into Rome after his investiture with the regal power,² and no doubt he felt honored by their attendance.

The accompanying illustration exhibits a racing quadriga copied from a tablet in the museum of Cardinal Quirini, in Brescia, Italy. Maffei, a competent connoisseur, says, in his "Dittico Quirini" (Veroni, 1784), that it is an excellent work of art. The picture here

given is only one of four contained in the bass-relief. The *auriga*, or charioteer, holds the reins in both hands, and as a precautionary measure has them slung around his body. On his hand there appears to be a glove of leather, overlaid with some material probably for ornament. The leather texture on the driver's body is very distinct, and strips of the same material are wound around his legs, as well as those of the horses, probably



RACING QUADRIGA.

ribbons intended to show to which faction the "concern" belonged. The bell fastened on the breast of the off-side horse is worthy of notice, as well as the "hang" of the body, intended to bring the "bearing" more effectually upon the axle-trees, to secure the chariot against accident.

The ancient circus may be described as an oblong square, with the corners rounded off. At one end was the starting-point, or *carceres*;

¹ Suet. in *Nero*, ch. 30.

² Tacitus, *Hist.*, B. II, ch. 87.

at the opposite one the *meta*, or pivot, around which the chariots in the race had to turn seven times :

“ Who claims the prize ere seven times round the goal
With grazing wheel the kindling chariot roll? ”¹

The accompanying engraving represents an upset quadriga, copied from a very well preserved bass-relief in terra-cotta among the antiques in the Imperial Museum, Vienna, Austria. In the original this is fifteen inches long and nine inches broad. There is sufficient reason for supposing this bass-relief to be the fragment of a frieze from some

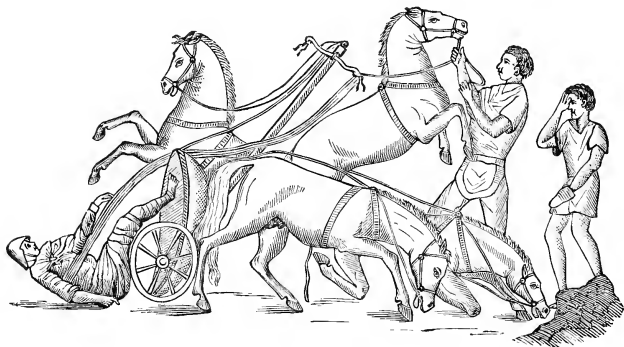

AN UPSET QUADRIGA.

old sepulcher, although no iron is found on the portion extant. Perhaps this picture may have reference to the death of some ambitious auriga, hurried away in the midst of a brilliant career; or to the demise of some popular charioteer, who, while turning around in his too rapid course, collided with the *meta*, snapping the fastenings of the yoke, and causing the off-side horses to fall, the others running back, or off and away.

The following lines give a very fair description of a chariot-race. It is a translation from Virgil's "Georgics" by Sotheby: —

“ See at the signal, when the chariots bound,
And bursting through the barriers seize the ground.
Now with high hope erect the drivers dart;
Now fear exhausts their palpitating heart.

¹ *Propertius*, Elegy XVII, ll. 25, 26.

Prone o'er loose reins they lash th' extended steed,
 And the winged axle flames beneath their speed.
 Now low they vanish from the aching eye ;
 Now mount in air, and seem to gain the sky.
 No pause, no rest ; where'er they sweep the ground
 Dust in thick whirlwinds darkens all around.
 Each presses each ; in clouds from all behind,
 Horse, horsemen, chariots thundering in the wind.
 Breath, flakes of foam, and sweat from every pore,
 Smoke in the gale, and steam the victim o'er."¹

Not only did the ancients put horses, mules, asses, oxen, camels, and elephants to their chariots, but we are told that they accustomed to the yoke the most ferocious animals.² On festival occasions the visitor might see in the circus lions, tigers, bears, stags, buffaloes, zebras, boars, etc., by couples or in fours, all peaceably drawing in a line. But it was not only at the great festivals in the circus, but also on ordinary occasions, when the emperors, high officials, or persons of rank and distinction gave gratuitous exhibitions to the people, that all sorts of beasts appeared on the ground, and were hunted and baited in different ways. Sometimes an immense number of foreign animals would be let loose at a given signal as a spoil or prey to the people. There are still many old coins in existence given out on such occasions. The Emperor Severus, in particular, gave such festivities to the public.

M. Cœlius, in writing to Cicero on a certain occasion, requests that, "Should you hear that I am chosen chairman (*sedilis*), be so kind as to procure for me some leopards";³ and in another letter he says, "In almost all of my letters I spoke to you of leopards. Atticus has sent ten to Curio, and it will be a shame if you don't send me a greater number. Curio has made me a present of this ten, and given me, besides, ten more of African origin. If you only would, you could easily do it, by procuring them from the Cibyratians [a people of Phrygia], or by writing to Pamphylia, where, I am told, many are captured." To this Cicero replies, "With regard to the leopards, I enjoined upon the hunters of these animals to be on the lookout, but

¹ *Georgics*, B. III.

² "Titus on one occasion brought into the theater five thousand wild beasts."—*Suet.* in *Titus*, ch. 6.

³ Cicero's *Epist.*, B. V, Letter II.

just now there are but very few of them to be found."¹ Pliny, in one of his Epistles, compliments his friend Maximus for his intention to hold a funeral festival for his deceased wife, on which occasion gladiatorial and prize fights were to take place, and he would be sorry if the panthers he had bought did not arrive in time.²

The Greeks were foremost in the art of taming wild beasts, and some of them made it their special business. Lampridius, in his Life of Heliogabalus, calls these beast-tamers *mansuetarii*. By great patience and some secret trickery they after a while were successful. Pliny says, "There exist certain plants which when mixed with the food or water given these animals have the effect of taming them."³ In the same passage he further tells us, "That neither lions nor panthers will dare to attack a man rubbed with the juice of garlic." It is also said in old authors, that a lion tied with a silk cord is afraid to bite through it. Lucian says, "They drag me around like a lion in a string"; and the pious Chrysostom, addressing the people of Antioch, exclaims, "You often see lions led about the markets, tamed like sheep."⁴

There exist a great number of relics in which bigas (two-wheeled vehicles) appear, some of which are drawn by lions, and driven by boys dressed as Cupids or genii. Sometimes tigers are substituted for the lions, as in our illustration, which exhibits a biga, and is copied from an antique cameo to be found in the renowned Barberinian Museum. Athenias informs us that in the festivals of Ptolemy Philadelphus all the bigas were driven by boys. In this instance

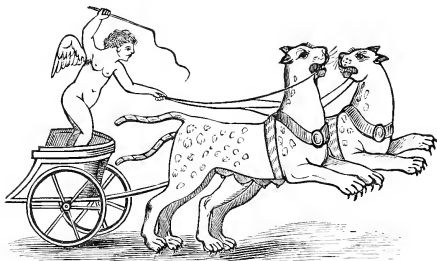

CHARIOT AND TIGERS.

¹ Cicero, B. II, Epist. II.

² Pliny's *Epist.*, B. VI, Epist. XXIV. Mark Anthony yoked wild beasts to his carriage after taming them.

³ Pliny, B. XXV, ch. 2.

⁴ "Iis etiam vulgo imperatores gaudebant, ait Joannes Chrysostomus ad Theodorum lapsus." A variety of Roman designs of carriages will be found in Montfaucon's *L'Antiquité Expliquée et Représentée en Figures*, Vol. IV, Part II, Paris, 1722.

the chariot is of a beautiful design and very light. One of the leopards at least is a female; and the savage team, so much feared by us now, seems to be represented here as under the complete control of the Cupid-boy.¹

Our next figure represents a biga drawn by two gazelles, or Egyptian goats, and is taken from a bass-relief in Pentelic marble, preserved in the Museum of Antiquities at Paris. The original is eighteen inches

long and three inches high, of very fine workmanship. Stags were more frequently used for draft than any other wild beast, of which we shall have occasion to say more in our "Italian World on Wheels." At Rome there may still be seen an antique bass-relief

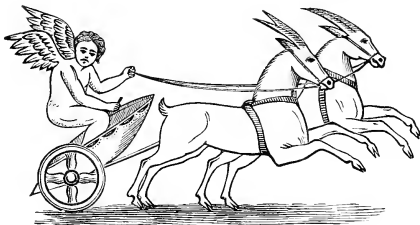

CHARIOT AND GAZELLES.

picturing a race with dog-bigas, which leads us to think that the use of such was not merely a humorous idea, but an evident reality. Martial, who visited the circus of old, and was doubtless a witness of what he writes, says, "Since panthers wear smooth yokes on spotted necks, and cruel tigers suffer lashings calmly; since stags champ golden bridle-bits; since Libyan bears are ground with the rein, and boars, as big as Calydon is said to have produced, do follow golden halters; since clumsy buffaloes do draw along essedes [wains], and elephants do not refuse flexibly dancing to a swarthy master, why should we not think ours a spectacle of the gods?"

Besides figuring in the race, the chariot was indispensable in gracing a Roman triumphal procession.² Plutarch, in his *Life of Paullus Æmilius*, gives us an account of one decreed him by the Roman Sen-

¹ A modern poetess sings:—

“On a gay car, by speckled panthers fleet,

Is drawn in gallant state a seeming queen.”—MRS. TIGHE'S *Psyche*.

² It appears that Tiberius was the first who entered the city of Rome in a chariot in triumph. “Germanico, quadriginta millia dedititorum trajecit in Galliam, juxtaque ripam Rheni sedibus assignatis collocavit, quas ob res, et ovans et curru urbem ingressus est primus, ut quidam putant, triumphalibus ornamentis honoratus, novo nec antea cuiquam tributo genere honoris.”—SÆT. in *Tib.*, ch. 9.

ate, from which we take the following particulars: "In every theater, or, as they call it, *circus*, where equestrian games used to be held, in the *forum* and other parts of the city which were convenient for seeing the procession, the people erected scaffolds, and on the day of the triumph were all dressed in white. The temples were set open, adorned with garlands and smoking with incense. Many lictors and other officers compelled the disorderly crowd to make way and opened a clear passage. The triumph took up three days. On the first, which was scarcely sufficient for the show, were exhibited the images, paintings, and colossal statues taken from the enemy, and now carried in procession in two hundred and fifty chariots. Next day, the richest and most beautiful of the Macedonian arms were brought up in a great number of wagons. These glittered with new-furbished brass and polished steel; and though they were piled with art and judgment, yet seemed to be thrown together promiscuously, — helmets being placed upon shields, breastplates upon greaves, Cretan targets, Thracian bucklers, and quivers of arrows huddled among the horses' bits, with the points of naked swords and long pikes appearing through every side. All these arms were tied together with such a just liberty that room was left for them to clatter as they were drawn along, and the clank of them was so harsh and terrible that they were not seen without dread, though among the spoils of the conquered. After the carriages loaded with arms walked three thousand men, who carried the silver money in seven hundred and fifty vessels, each of which contained three talents and was borne by four men. Others brought bowls, horns, goblets, and cups all of silver, disposed in such order as would make the best show, and valuable, not only for their size, but the depth of the *basso-relievo*.

"On the third day, early in the morning, first came up the trumpets, not with such airs as are used in a procession of solemnity, but with such as the Romans sound when they animate their troops to the charge. These were followed by one hundred and twenty fat oxen, with their horns gilded and set off with ribbons and garlands. The young men that led these victims were girded with belts of curious workmanship, and after them came the boys who carried the gold and silver vessels for the sacrifice. Next came the persons that carried the gold coin in vessels which held three talents each, like those that contained the silver, and which were to the number of seventy-seven.

Then followed those that bore the sacred bowl, of ten talents' weight, which Æmilius had caused to be made of gold and adorned with precious stones; and those that exposed to view the cups of Antigonus of Seleucus, and such as were of the make of the famous artist Thericles, together with the gold plate that had been used at Perseus' table. Immediately after was to be seen the chariot of that prince, with his armor upon it, and his diadem upon that; at a little distance his children were led captive, attended by a great number of governors, masters, and preceptors, all in tears, who stretched out their hands by way of supplication to the spectators, and taught the children to do the same. There were two sons and one daughter, all so young that they were not much affected with the greatness of their misfortunes. This insensibility of theirs made the change of their condition more pitiable, insomuch that Perseus passed on almost without notice, so fixed were the eyes of the Romans upon the children, from pity of their fate; and many of them shed tears, and none tasted the joy of the triumph without a mixture of pain till they were gone by. Behind the children and their train walked Perseus himself, clad all in black, and wearing sandals of the fashion of his country. He had the appearance of a man that was overwhelmed with terror, and whose reason was almost staggered with the weight of his misfortunes. He was followed by a great number of friends and favorites, whose countenances were oppressed with sorrow, and who, by fixing their weeping eyes continually upon their prince, testified to the spectators that it was his lot which they lamented, and that they were regardless of their own. He had sent, indeed, to Æmilius to desire that he might be excused from being led in triumph and being made a public spectacle. But Æmilius, despising his cowardice and attachment to life, by way of derision, it seems, sent by word 'that it had been in his power to prevent it, and still was, if he were so disposed,' hinting that he should prefer death to disgrace. But he had not the courage to strike the blow; and the vigor of his mind being destroyed by vain hopes, he became a part of his own spoils. Next were carried four hundred coronets of gold, which the cities had sent Æmilius, along with their embassies, as compliments on his victories. Then came the consul himself, riding in a magnificent chariot, — a man, exclusive of the pomp of power, worthy to be seen and admired; but his good mien was now set off with a purple robe interwoven with gold, and he held a branch of laurel in

his right hand. The whole army likewise carried boughs of laurel, and, divided into bands and companies, followed the general's chariot, some singing satirical songs usual on such occasions, and some chanting odes of victory and the glorious exploits of Æmilius, who was revered and admired by all, and whom no good man could envy."¹

Plutarch likewise tells us that Camillus, who was greatly elated with a victory over a rival city, "after a siege of ten years, misled by his flatterers, took upon him too much state for a magistrate subject to the laws and usages of his country; for his triumph was conducted with excessive pomp, and he rode through Rome in a chariot drawn by four white horses, which no general ever did before or after him. Indeed, this sort of carriage is esteemed sacred, and is appropriated to the king and father of the gods."²

The annexed illustration represents a section of the triumphal procession in bass-relief on the arch erected in honor of the Emperor

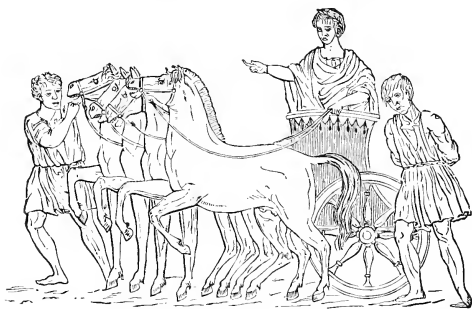

TRIUMPH OF TITUS.

Titus at Rome, still standing. The poutrels and throat-latches in the harness of the horses are remarkably well delineated. The figure standing in the chariot, with one arm outstretched and the other holding the reins, represents the emperor in whose

honor the procession is instituted. Behind him follows a captive taken in battle, who in this case is the representative of many others usually gracing such occasions.³

¹ Plutarch's *Life of Æmilius*. This triumph was celebrated B. C. 167.

² Plutarch's *Life of Camillus*.

³ "Germanicus Cæsar, after his victories over various nations, in a triumph voted him, carried all the spoils and captives, with representations of the mountains, rivers, and battles. . . . His own singularly fine person, and his chariot filled with his five children, heightened the admiration of the beholders."—TACITUS, *Ann.*, B. II, ch. 41.

Among the Romans great attention was paid to the funeral rites for the dead, and no misfortune was deeper felt than the loss of the body of a friend by shipwreck or other causes. In earlier days they interred the remains in the earth, the ancient and more natural way, but in after times they were burned to ashes on the funeral pile. This to them important ceremony could not be performed where the body was not found. The burning of corpses, according to Pliny, was instituted to prevent the digging up by the enemy of the bodies of such Roman soldiers as fell in distant wars. Sylla ordered his body burned after death, lest some one, if buried, should dig it up and scatter the remains, as they had done those of Marius. Under the emperors the custom was almost universal, and was only abandoned, under the influences of Christianity, about the end of the fourth century.

The engraving is supposed to represent a portion of the funeral cortege of a distinguished sportsman (some think Meleager) on its way to the funeral pile. The original in bass-relief is deposited in the Barberinian Palace at Rome. The monument on which it appears covered the grave of the hero.

The bier with the body is not seen, but the two dogs in the care of a slave, and the stringless bow in the hands of the charioteer, are very significant, in view of the fact that such

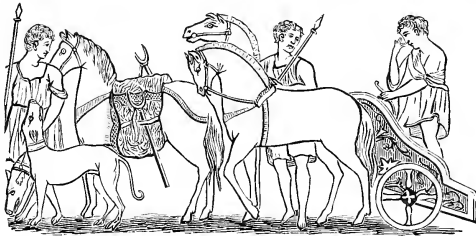

PORTION OF A FUNERAL CORTEGE.

animals as were favorites with the dead were slain, and the bodies, with other coveted effects, thrown on the pile of pine, fir, or oak wood, which was lighted with a torch of rope covered with wax or tallow. After opening the eyes and kissing the corpse, some near relative set fire to the pile with his back to it, in token that he did so with reluctance. After burning, the ashes were gathered up and carefully put in an urn made of either marble, brass, silver, or gold, according to the wealth or rank of the family, and deposited in the sepulcher.

The *rheda* was evidently a great favorite with the Roman people, and of three kinds: the military or state *rheda*, the post *rheda*, and

the private or family rheda. Their invention is attributed to the Gauls, the Romans afterwards having adopted them. Some were hung on two and some on four wheels. The frame of the carriage, as well as the two-wheeled car, was called *rhedia*; the body of the car resting on the axle-tree was fastened by two wooden pins or bolts, and was drawn by a pole secured to the axle at one end, and by a pin at the other to a yoke, as in the ancient war-chariots of Assyria and

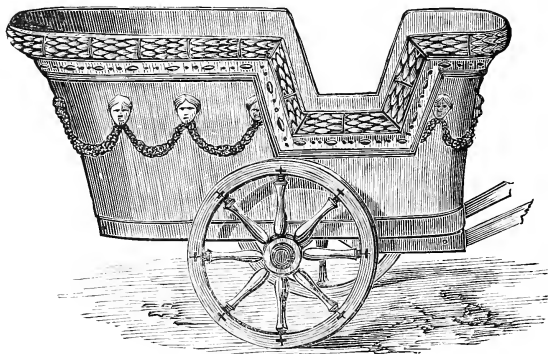

TWO-WHEELED RHEDA.

Greece. The vehicle here shown is hung off quite low on the axle-tree, and is made low in the side for the entrance of passengers. They are supposed to have seated six persons,

three on each seat, with ease. It appears to have been richly ornamented, but when hung on two wheels must have been "hard on horse-flesh." These vehicles were used for various purposes, and were generally drawn by oxen. Cicero, in writing to Atticus on one occasion, says, "*Hanc epistolam dictavi sedens in rheda*,"¹ from which we infer that the movement of the vehicle was slow and steady enough to allow the passenger to write a letter while traveling; and we learn from other authors that they were employed in conveying materials of

¹ Cic., *Att.*, B. V, 17. After their expeditions into Gaul and Britain, the Romans adopted the *essedra* for their own purposes, as being much lighter than the *rheda*, not only in travel but also in solemn processions. It is evident in a passage from Ovid that the *essedra* in time became very fashionable with the young ladies, themselves holding the reins in driving. Ovid, *Amor.*, B. XVI. In a letter to Atticus, Cicero says, "*Hic vedius venit mihi obviam cum duobus essedis, et rheda equis juncta, et lectica, et familia magna. . . . Erat præterea cynocephalus in essedo: nec deerant onagri.*"—*Ciceronis ad Attico*, B. VI, Epist. I. The *essedra*, *rheda*, and *litter* appear to have been the most common vehicles in daily use with the Romans.

war, money, and other goods. The Theodosian Code ordained that this should not carry more than one thousand pounds' weight, and that eight mules in summer and ten in winter should be yoked to it.¹ Constantine also ordered that no one who traveled on public business should dare to demand the oxen of the peasantry, but employ those only kept for the public service.

The state rheda was strongly built, and for security was enclosed all around, to protect the occupants from danger, or to insure the safety of goods and money. It was decided by law that "when gold or silver presents shall be sent, the rheda shall not carry more than five hundred pounds of gold or one thousand pounds of silver"; and further, that "only the finer apparel and the linen necessary for use to the weight of one thousand pounds shall be carried by the government." Unlike some monopolies of the present day, conveyance in these vehicles was perfectly safe, and goods intrusted in them were seldom lost. This, as we have seen from Cicero's letter, was a slow vehicle.

The post rheda was evidently a lighter carriage and a much more expeditious vehicle of travel. Suetonius, in his *Life of Cæsar*, says that, "In a hired rheda he made the longest journeys with extraordinary rapidity, going daily a distance of one thousand steps," or nearly ninety-five miles. From various authors we learn that these post rhedas were easy and comfortable, the seats being hung in straps, and furnished with soft bolsters and pillows. They were regularly stationed in sufficient numbers at the post-houses for the public convenience. Thus the military, public officers, couriers, or private persons were furnished with every necessary convenience for business or travel. Special laws were instituted, that "when a district selects deputies, to whom their designs have been confided, they shall be provided for their accommodation with a rheda."

The third-class or family rheda is alluded to by Juvenal.² Martial, also, in his *Epigram on Bassus*, describes an epicurean as "driving from his country estate into town in his full rheda, bearing all the fruits of this fruitful earth. You might have seen the broad lettuce, the onions and garlic, and the cabbages, not unsuited to the delicate stomach. Near them lay a garland of fat fieldfares, a hare wounded by a dog, and a sucking pig."

¹ *Theod. Code*, IX. ² "Tota demus rheda componitur una."—*Juv.*, B. I, *Sat.*, III, 10.

According to Paulus, the rheda must in some instances have been supplied with a covering, for he mentions various articles as being necessary to furnish a traveling equipage, as "a carpet for the feet, the soft packing skins, straps, and the linen cover to spread over the carriage." Pliny tells us that he made a journey to Rome in a rheda with great comfort. "The stout leather surrounded and curtained it

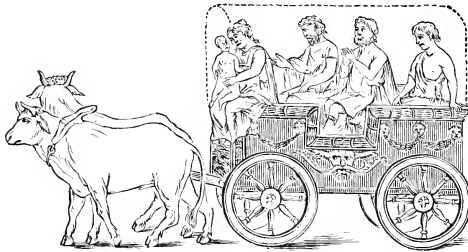

MILITARY OR STATE RHEDA.

securely from the wind and frost, while the latticed windows with their linen blinds let in the softened light, and the well-filled bolsters covered the easy seat." The frame-work or bows for the top were made of birch poles, bent

to an arch, and extending across the body, as in our grocery or business wagons. Although very clumsy in the judgment of a modern carriage-builder, still the rheda must have been a superior vehicle when compared with the carruca, or its adoption from the Gauls might not have taken place.

Rheda meritoria was the name of a sort of hackney-coach used among the Romans, both open and closed. In those early times many kinds of wagons were found ready to do hack service, which were generally denominated *vehicule meritorie*. Mail service had been instituted chiefly for state officers' and the emperor's use, and consequently business men or others traveling for private purposes had to employ these hackney vehicles. Some of the most distinguished citizens of Rome, and even emperors sometimes, found it necessary to ride in them. Suetonius says of Julius Caesar that he accomplished, free of baggage, the longest journeys in an incredibly short space of time,¹ and Plutarch completes the report by saying that this journey

¹ "Longissimas vias incredibili celeritate confecit, expeditus, meritoria rheda, centena passuum millia in singulos dies."—Suet. in *C. J. Caesar*, ch. 57. On one occasion he set out for Gaul after sunset in a vehicle drawn by mules taken from a neighboring mill. "Dein post solis occasum mulis e proximo pistrino ad vehiculum junctis occultissimum iter modico comitatu ingressus est."—Suet. in *C. J. Caesar*, ch. 31.

was accomplished so quickly that Caesar arrived on the banks of the Rhone in eight days after his departure from Rome.¹ Tacitus says that when Messalina discovered her dangerous situation, she concluded to meet her husband, Claudius, and at the gate of the city she found a common wagon, and mounting it, with three other persons drove to Ostia. Pliny tells us in one of his letters, "I decided to travel to the province, partly in market ships and partly in hackney vehicles";² and Horace, in the Three Satires, mentions that after having traveled in the market ships, he and his friends rode farther on mules, sitting

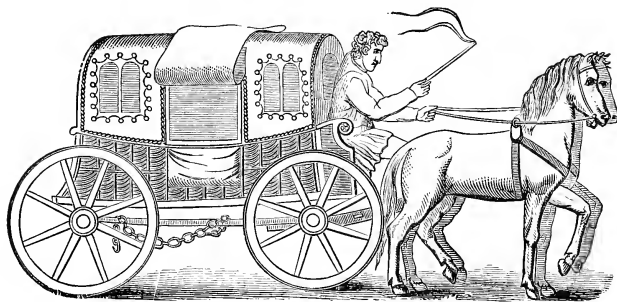

HUNGARIAN CARRIAGE, AFTER GINZROT.

in *cittadelles*; and in the same passage he speaks of having traveled twenty-four *miglia* in hackney vehicles. We know that when Nero set out against the rebellious Gauls, he took particular pains to carry along with him in wagons all his musical instruments, but not in his own. These are supposed to have been put into a covered vehicle which Ginzrot says was the *rheda*, similar to a Hungarian carriage then in use.

The *carruca* was introduced into Rome much later than the *carpentum* (p. 139) already noticed. Although mentioned by Pliny³ and others, very little is known concerning them. They are said to have been first-class vehicles, ornamented with gold and precious stones, and that the Romans considered it an honor to ride in those that were hung remarkably high. In the Theodosian Code the use of them is not only allowed to civil and military officers of the foremost rank,

¹ Plutarch, *Cæs.*, p. 716.

² Pliny, *Epist.*, B. X, 26.

³ Pliny, *Epist.*, B. X, 33, 49.

but commanded, as a mark of their dignity.¹ These carrucæ had a frame on which they were hung either higher or lower, but of a clumsy appearance. If designed merely for show, it sustained an elevated weight; if for sleeping, the body was hung somewhat lower.

The name "carruca" is derived from *currus*, the Latin for chariot, which, as our readers have seen, was in use among the Egyptians and



THE CARRUCA.

Assyrians long anterior to the foundation of Rome. From the word *carross* the English word "carriage" is supposed to have come. It would appear from a passage in Horace that the carruca was originally made like the *pilentum* and *apene*. According to Ammianus, "it was a great thing for persons to have a four-wheeled carruca built higher than anybody else, for in these they could be seen better than in any other." Extravagant sums are reported to have been expended in decorating the carruca by the wealthy Ro-

mans. Martial, in one of his Epigrams, tells us that this vehicle in some instances "had cost a country estate." Suetonius, in his Life of Nero, says that tyrant in his journeyings never had less than three thousand carrucas in his train, and that all the mules drawing them were shod with silver. The passion for splendor and show among the luxurious Romans raged so high that in order to check the evil severe measures were adopted.

Besides these we have described, the Romans had other vehicles, concerning which scarcely any two writers are agreed. Adams, in his "Roman Antiquities," tells us that the *thensa* was "a splendid carriage with four wheels and four horses, adorned with ivory and silver, in

¹ See *Codex Theod.*, B. XIV, Tit. 12, and *Codex Justin.*, B. XI, Tit. 19.

which the images of the gods were led in solemn procession from their shrines at the Circensian games to a place in the circus called *pulvina*.”¹ Ginzrot devotes a chapter to the *thensa*, and illustrates it with a *birota*, or two-wheeled vehicle, very much like the *pilentum*. The weight of testimony pronounces it a four-wheeled vehicle, and the fact that it was moved by thongs (*lora tensa*) stretched before it — from which circumstance it received its name — is still further evidence; for it would be almost impossible to draw a two-wheeled vehicle with a rope. On these solemn occasions persons of the first rank, dressed in magnificent apparel, attended the pageant, considering it a delightful and blessed privilege to be allowed to even touch the ropes. Under the emperors, the decreeing of a *thensa* to any one was an acknowledgment of his divinity.²

Benna was the name of a rustic wagon which figures on the Arch of Trajan at Rome, a reduced copy of which is shown in the illustration. The body of

the vehicle, drawn by mules, appears to have been made of twisted grass rope, sewn together and placed on a platform or bottom of wood, framed. The wheels are supplied with

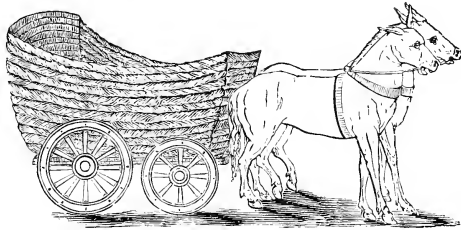

THE BENNA.

twelve spokes, an unusually large number. This must have been a very common vehicle, probably used chiefly by the common people. *Petrorritum*, *sarraca*, *scirpea*, *chamulcus*, *epirhedum*, etc., were the names of other vehicles, of which we have but little knowledge, and therefore cannot describe them.

The engraving on next page exhibits a bird's-eye view of a Roman carriage-part or gear for four-wheeled vehicles, which were nearly all alike, the change being to accommodate them to the different bodies

¹ Suet. in *Aug.*, 43, et *Vesp.*, 5.

² “Omnes Dii, qui vehiculis thensarum solennes cœtus ludorum initis.” — CICERO, *Verr.*, V, 72. “Neronem diebus ultimis monitum per quietam, ut thensam Jovis Opt. Max. e sacratio in domum Vespasiani et in circum deduceret.” — SUET., *Vesp.*, ch. 5. This dream he interpreted as being fortunate.

hung thereon. When a square body with curved rails was mounted on it, it was called *canathra*, *sirpea*, *benna*, etc. When the body was paneled and covered with a top, half or full, the vehicle was known as an *arcera*, *rheda*, *carruca*, *vehiculum arceratum*, or *cameratum*, etc. For all vehicles, of which the monuments only show the wheels, the plan may be taken as a fair representation of the whole, by making a proper allowance for the lengths of the different bodies used. When

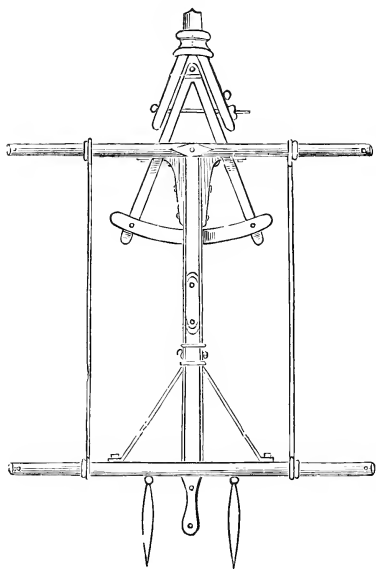

ROMAN CARRIAGE-PART.

a wooden platform merely was used on these under-carriages, the vehicle thus constructed was called a *plaustrum majus*, and was used by the business classes for carrying bags, bales, and goods.

Among the ancients strength was of more importance than beauty in a carriage. The frame-work shows such to have been the case. As in our example, these consisted of two axles, connected by a perch or pole, generally straight, and firmly fixed in the fore-axle, where it was secured by iron plates and bolted. The hind end was mortised into the back axle, and strengthened by two iron wing-braces, as is sometimes done in modern carriages, and the whole was additionally

strengthened by two wooden bars, as shown in the engraving. Between the center of the perch and under the floor of the body two props were placed as a support to the center. To these ancient carriages spring yokes were sometimes applied, and often in the better class supported on the ends of elastic poles, where they were secured by iron rings or sockets. These poles were attached to the axles, and as the weight was not directly on them, but on the ends of the poles, the motion of the carriage was thereby relieved. Sometimes a greater number of

poles were combined with the same end in view. These primitive springs may at first sight appear to have had but little value; when we consider, however, that many kinds of hard wood preserve their elasticity for a long period, we may believe that when tapered and properly arranged both the motion and the draft would be much easier than in carriages made without them. The poles were bound to the axle by iron bands called axle-girdles. The axle-trees in inferior carriages were mostly made of wood and sometimes strengthened with iron. In the better class the tree was fitted into an iron bush which entered the hub, and again the entire axle was made of iron. On this axle the wheel was invariably secured by a linchpin. The under side of the fore-carriage was coupled to the upper portion by a sort of king-bolt, which aided the turning about of the vehicle, as in modern times. By splitting the ends of the pole, and attaching it to the ends of the furchells by a bolt, is shown one of the most simple modes of coupling poles to a carriage. The pole was not fixed or stationary at the end, as in two-wheeled carriages, but worked on a long bolt, in order to relieve the horses of the weight, and was kept in its place by a support fastened at the ends of the forked frame or furchells. On the back of the frame two chairs or straps were placed, that when passing over precipitous grounds, if necessary, force might be applied to break the momentum and prevent the carriage from running down hill. Many of the Roman carriages were exceedingly strong and heavy; intercourse with distant countries was continually kept up by them, and goods, materials of great weight and value, were daily passing to and from the different cities; so that it was necessary to provide such appliances as would under all circumstances be requisite.

The odometer, or road-measurer, appears to have sometimes formed a part of the fixtures of a Roman carriage. Vitruvius, in describing a carriage, says, "From the side of the carriage, and connected with the interior machinery, a finger or rod jutted out, which at every revolution of the wheel came in contact with a projection against which it rubbed, and a sound was made, and the hand was moved forward on the indicator. In this manner the number of paces which had been accomplished were shown, and the riders knew exactly how much of their journey had been performed."¹

¹ Vitruvius, B. X.

Pliny, to whom we are indebted for much information relating to carriages, tells us that one Myrmecides, an artist of his time, made and exhibited a carriage and horses of brass, ivory, and marble, the whole no larger than a fly. An energetic people, such as the Romans were, no doubt had a great variety of carriages, many of which, not possessing the character of public vehicles, have been neglected by both the writers of poetry and history, and consequently their names as well as form are now irrecoverably lost. Speculation may serve to confuse the mind of the student of history, but will give very little satisfaction to the sober reader.

There is extant a modern work entitled "*Roma Antica e Moderna*," in which are shown numerous engravings of carriages of the eighteenth century, drawn by two and four horses, some of them opening at the center of the head, driven by coachmen in livery, with footmen perched up behind, engaged in setting down passengers at the doors of monasteries, etc. Among these are coaches, gigs, and sedans similar to others then in fashion in other portions of the continent of Europe, but which we must omit for want of room.¹

¹ See *Roma Antica e Moderna*, by Guisepe Vasi, 2 vols., Rome, 1756.

CHAPTER VI.

PAINTED ITALIAN CARRIAGES FROM RUINED CITIES AND OTHERS, ON
THE ROAD.

“Vesuvius answered : from its pinnacles
 Clouds of far-flashing cinders, lava showers,
 And seas drank up by the abyss of fire,
 To be hurled forth in cataracts,
 Like midnight mountains, wrapped in lightnings, fell.

Awful sounds of heaven and earth met now,
 Darkness behind the sun-god's chariot rolled.”

FAIRFIELD'S *Destruction of Pompeii.*



CENTURIES have multiplied since Pompeii and Herculaneum¹ were overwhelmed with a mass of *débris* thrown from the bowels of Vesuvius, destructive alike to everything of a perishable nature, among which were the carriages then in use. Luckily, however, the public and private edifices have served as

the art depositories for sculpture and paintings to all future generations. From these we are enabled to form a very correct idea of the state of vehicular art then in practice.

¹ The cities of Pompeii and Herculaneum were anciently independent of Roman sway, but in the course of time, through political indiscretions and intermeddling with the quarrels of their neighbors, they drew down upon themselves the enmity of that powerful nation. Once reduced to subjection, the laws and customs of the Latin race were forced upon them, in place of those of Greece, from whence the people originally came. (Suet. in *Aug.*, 98.) In this humiliating condition the citizens stood in A. D. 79, when, in a single night, the entire population were suddenly buried beneath a heterogeneous mass of stones, cinders, and ashes vomited from Vesuvius. In this

The next illustration is copied from a painting found at Pompeii, representing the entrance to a temple, over the door of which, on the wall, this car of the goddess Victory was found, in colors of gold. The celestial deity appears with whip in hand, inciting her spirited

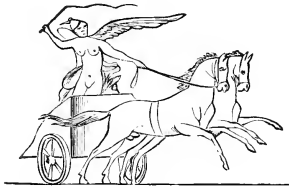

VICTORY.—POMPEII.

coursers to greater speed, just as any earthly mortal might be expected to do. The chariot itself is modeled very much like others which follow in this chapter. As is the case generally with paintings from these overthrown cities, the artist has neglected to supply the details required to show the mode of harnessing the horse to the vehicle,—a matter very

much to be regretted, since we have no means of supplying the deficiency from any other source. Although the Pompeiians originally came from Greece, and art might naturally be expected to show some characteristics of that people, yet, singular as it may appear, the vehicles were modeled more after those of Rome.

From the ruins, among other curiosities, we select an illustration from an arabesque. The bird introduced as drawing the biga represents a parrot, and it would seem as though the pall-covered vehicle

state, for ages in obscurity, remained some of the choicest gems of the painter, on which are delineated the vehicles of a festive but intelligent race.—According to Salinus, Pompeii received its name from the Greek word *ΠΟΜΠΗ*, in allusion to the pomp with which Hercules celebrated his victories, while awaiting his fleet at the mouth of the Sarnus, which flows into the Bay of Naples, now known as the Sarno. Sixteen years previous to its overthrow, which happened in the ninth year of Nero's reign, the city had been visited by a very severe earthquake, throwing down a large proportion of the buildings, which at the time were rapidly being rebuilt. It will therefore be understood that the destruction of this city—as well as Herculaneum, named in honor of Hercules—was the work of two distinct periods of calamity. Pompeii was suffered to remain in a buried state down to 1748, when excavating began, and it was ascertained that the ruin of the city was not accomplished by uniform showers of pumice-stones and cinders, as many have supposed, but by a succession of volcanic eruptions. In some places the *débris* lies in five distinct tiers, twenty feet deep, the three being composed of pumice-stone in small pieces, resembling a light cinder, the next six parts beginning with a stratum of small black stones, not more than three inches deep; next to this a layer of mud or earth mixed with water; on this a thin series of light stones of a mixed hue, blue predominating. A stratum of mud, separated by a thin, wavy line of mixed blue stones, completes the fourth. The fifth, or highest division, is earth which has accumulated during the past seventeen centuries.

driven by the locust was emblematical of destruction, the entire picture representing a funeral cortege, in which the remains of Love are borne to the grave. The ancients were accustomed to represent affection by the figure of the parrot. Statius, a Latin poet of much celebrity, in one of his sweetest moods, calls this loquacious bird the "*humanæ solers imitator linguæ*," — a clever imitator of the human voice.¹

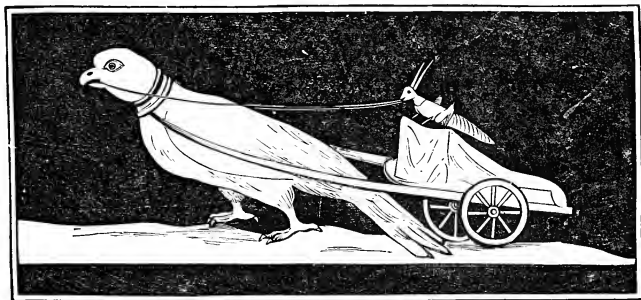

PARROT BIGA.—POMPEII.

In an elegy mourning the death of a parrot given to his Corinna, Ovid says, "The parrot, the imitative bird, sent from the Indies of the East, is dead. Come in flocks to his obsequies, ye birds! Come in flocks to his obsequies, ye denizens of air, and beat your breasts with your wings, and with your hard claws disfigure your delicate features! . . . Turn your attention to a bird so prized. It is a cause of sorrow, but still that is so old. All who poise yourselves in your career in the liquid air, but you above the rest, affectionate turtle-dove, lament him. Throughout life there was a firm attachment between you, and your prolonged and lasting friendship endured to the end. What the Phocion youth was to the Argive Orestes, this same parrot was the turtle-dove to you, as long as it was by fate."²

¹ The poets of antiquity were fond of connecting birds with the chariot or car. In the beautiful Hymn to Venus, Sappho says, addressing the goddess, —

"The car thy wanton sparrows drew;
Hovering in air they lightly flew."

"Four white doves, out of the many that nestled about, . . . advanced, and bending their painted necks to the jeweled yoke, flew forward with the chariot. Around it wantoned chattering sparrows," etc. — APULEIUS, *Golden Ass*, B. VI.

² Habington, an English poet of some celebrity, has sung, —

The next engraving represents the chariot of Venus, driven by her son Cupid, generally, or at least sometimes, represented as drawn by swans, and in other cases by swallows or doves. This chariot from Pompeii was formed of carved and gilded ivory. As usual, it has eight spokes to each wheel. Tak-

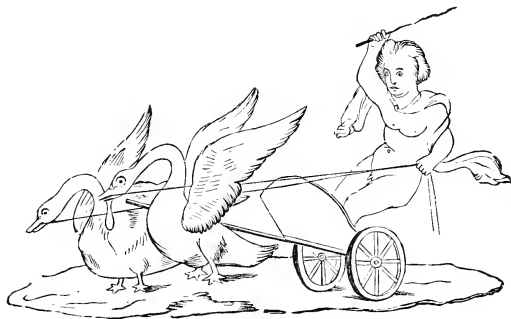

SWAN CAR.—POMPEII.

ing this example for a model, we have no very exalted idea of the taste displayed by Venus in the selection of her equipage, nor of her son's wisdom in the choice of his team.¹

Lucian, a learned and witty author, makes Cupid say, "I make myself familiar with lions themselves; I ride upon their backs; I hold their manes and use them for bridles; they wag their tails and lick my hands in flattery of me."² This familiarity with the monarch of the forest evidently suggested to the painter the subject embraced in the next picture, wherein the boy-god is mounted on a chariot similar to the preceding, of faulty design. It aptly illustrates the unequal yoking of many pairs in the matrimonial state. Here we see the lion with the tiger "illy matched," and Cupid undertaking the difficult task of guiding the team. We may readily anticipate the result. Notwithstanding

"Thanks, Cupid, but the coach of Venus moves
For me too slow, drawne but by lazie doves.
I, lest my journey a delay should find,
Will leape into the chariot of the winde."

¹ Thus sings Propertius:—

"Let snow-plumed swans forever waft thy car,
Nor steeds strong thundering whirl thee to the war."

Elegy, III, ll. 43, 44.

² Lucian, the well-known Greek writer, was a native of Samosata in Syria. His learning obtained for him the registrarship of Egypt under the Emperor Aurelius. He died A. D. 180, aged ninety years.

the solid foothold provided for him by an ingenious placement of the axle and wheels at the rear end of the car, we conceive that with such

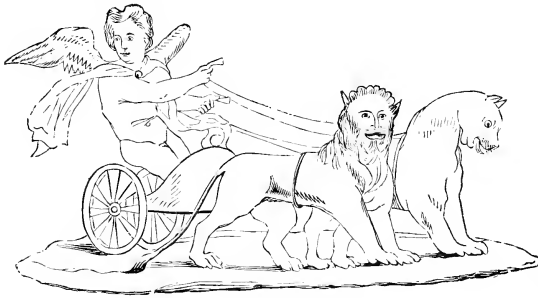

MIXED TEAM.—POMPEII.

a *coupling* his skill as charioteer must indeed be sorely taxed. The lion represents the male partner and the tiger the female,—each acting out their natural tempers

at the start, ay, before starting. It is evident that in this case "love can never run smooth." In the very countenance of the lion defiance is stamped; in that of the tiger, self-will. The one intends to lead, the other not to be led,—a pretty pair of contraries. The result is readily foreseen.¹

Possessing but little taste for the fabulous, we are not much inclined to speculate about the griffin, so cleverly harnessed to the vehicle here shown.

This symbolized combination of two different natures exists only in fancy. Physiologists have demonstrated that such could not live in our

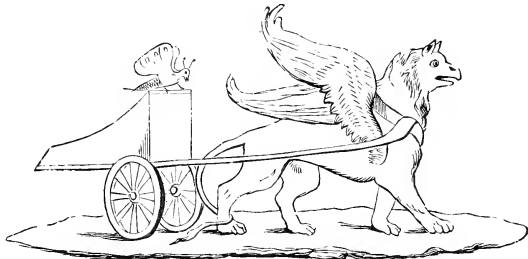

BIGA AND GRIFFIN.—POMPEII.

Probably the ancients borrowed this creation from the Scriptural account of the cherubim, connected with the religious rites of the

¹ "The Carthagenians adored the goddess Juno as a virgin traveling through the heavens in a car drawn by lions."—APULEIUS, *Golden Ass*, B. VI.

Hebrews.¹ The winged bulls of the Assyrians, which the recent researches of Layard, Botta, and others have brought to light, are supposed to have had the same origin: like as the cherubim guarded the gates of paradise, so likewise the winged bulls in stone were placed, silent sentinels, before the palaces of royalty. In conformity, then,



CAR OF APOLLO.—HERCULANEUM.

The above illustration, representing a car of Apollo, is copied from a picture among the ruins of Herculaneum, upon the walls of an edifice. The general design presents a pleasing cast, compared with others found in this volume, and is loaded with the instruments of music sacred to the god. The

blanket of course is intended for the protection of the instruments from the effects of the weather. The body of this vehicle is exquisite in design. The griffins are usually represented as being sacred to the sun, in classical language meaning Apollo.



PILOTELLUM.—HERCULANEUM.

¹ See Exodus, ch. xxxvi, v. 6-9.

² We may observe, *en passant*, that the butterfly represented Psyche, the mystical emblem of the soul, among the Grecians. The griffin was supposed to watch over hidden treasures.

The preceding picture represents a *plostellum*, or child's carriage, drawn by youths. The word *plostellum* is the diminutive of *plaustrum*, several examples of which will be found in this volume. The design differs widely from others in this series, and has likewise been rescued from the ruins of Herculaneum, in which city it was evidently made a child's plaything.

The next is from Herculaneum, intended to represent the car of the goddess Minerva, to whom the owl was sacred. She is reputed to have been the daughter of Jupiter, born without a mother from the brain of the Thunderer, and the patroness of arms. Homer says that on a certain occasion she "let flow down on her father's floor her dainty robe of variegated hue, which she herself had wrought and worked with her own hands; then she, having put on her tunic, equipped herself for the tearful war in the armor of cloud-compelling Jove, and around her shoulders she then threw the fringed *ægis*, dreadful. . . . On her head she placed the four-crested helmet, with a spreading metal ridge, golden. . . . She then stepped into her shining chariot with her feet, and took her spear, heavy, huge, and sturdy, with which she, sprung from a dread sire, subdues the ranks of heroic men, with whomsoever she is wroth."¹



MINERVA'S CHARIOT.—HERCULANEUM.

¹ Homer's *Iliad*, B. V, v. 734 *et seq.*, Bohn's Edition.

The next picture represents a swan-necked car, drawn by mules and driven by Love, dug out of the ruins of Pompeii. As a matter of taste, this picture is not of much importance. We suspect, however,

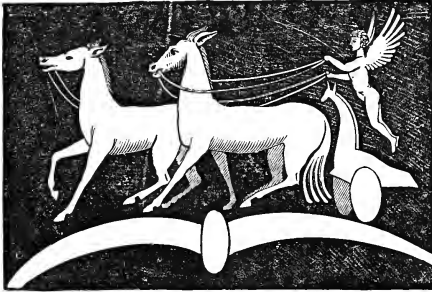

MULE CAR.—POMPEII.

that the artist, in compliment to the character of a stubborn mate, or in retaliation upon the winged deity for some fancied neglect, spent some time in producing it. At any rate there was meaning, as previously observed, in thus yoking stubborn brutes to the car of the fickle god. The appearance of the wheels carries

us back to the period when art was in its infancy and wheels were made from logs.

The figure below represents the car of Diana, who, according to ancient mythology, was the reputed daughter of Jupiter, by Latona, the twin sister of Apollo. The temple of this goddess at Ephesus was reckoned one of the wonders of the world, when only seven were in existence. To appease the wrath of this deity required the sacrifice of Iphigenia, in conformity with an oracle, in consequence of Agamemnon's having by mere accident killed one of her stags.¹

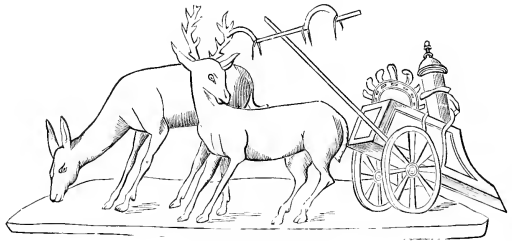

CAR OF DIANA.—POMPEII.

A chariot similar to the above in form, in mosaic, may be seen in the Louvre. It is drawn by four horses, in which is mounted

¹ See Ovid's *Met.*, B. XII, v. 24. In the Apollo Gallery of the Louvre are shown in one mosaic several bigas, drawn by male and female sheep, deer, goats, lions, dogs, boars, and tigers.

a female holding an image of victory. Following the chariot are two more females, one carrying a cornucopia in the left, the other holding an olive-branch and an inverted horn-of-plenty in the right hand.

The next illustration was taken from the walls of the tablinum of the peristyle of the Dioscuri,¹ the original of which is painted on a yellow ground. In this instance we see a rudely formed chariot

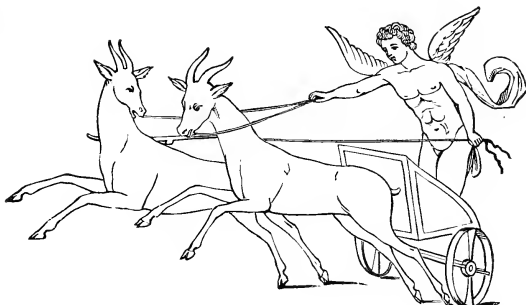

FEMALE GOATS AND CHARIOT.—POMPEII.

drawn by two goats, the harness and other furniture being wholly omitted, — a thing frequently observed in ancient relics. The chariot



MALE GOATS AND CHARIOT.—POMPEII.

¹ Or temple of Castor and Pollux. These brothers are reputed to have freed the seas of pirates.

is defective in several points, angles taking the place of graceful lines, characteristic of Grecian art. This, however, may possibly be charged to lack of skill on the part of the painter, and not to ignorance or defect in the mechanics of the day. In sketching the goats the painter has shown more skill, and succeeded in improving upon nature. Nothing can exceed the beauty and gracefulness in which they appear.

Another fine picture, in which Cupid still acts as charioteer, is given on the preceding page. This genius, ancient writers inform us, was the son of Venus, who took upon himself the direction of all love affairs among mankind. In this instance we find him mounted in a firmly constructed chariot, endeavoring to force along an unruly pair of male goats. What is symbolized by the artist we have not been able to discover, but we have no doubt there is a depth of meaning in this picture of much interest, could we unravel it.

The annexed figure represents a picture similar to the foregoing, except that the draft animals are evidently females, and the chariot of different design from the last. This, although graceful in execu-



SHE-GOATS AND CHARIOT.—POMPEII.

tion, is more fragile and less calculated to endure hard usage. To govern the team seems to require the best efforts of the teamster, while the animals look decidedly vicious. May we not read in this, as well as in the preceding picture, true specimens of human nature, as exhibited in affairs of the heart in later times?

The next engraving is a biga taken from an allegorical picture found in good preservation at Herculaneum. This, singularly enough, in the original is represented as being drawn by two sheep. There are but six spokes in each wheel. These spokes, as well as some of the Roman, are said to have been wood, while those in the Grecian wheels were usually metal. Compared with the rims they are disproportionately light, —

an apparent blemish in many ancient wheels.

The next chariot is similar to the last, and like it with sides tapering from front to rear, so as to expose the passengers to view while engaged in the race, for which purpose this and the previous chariot were evidently intended. In common with

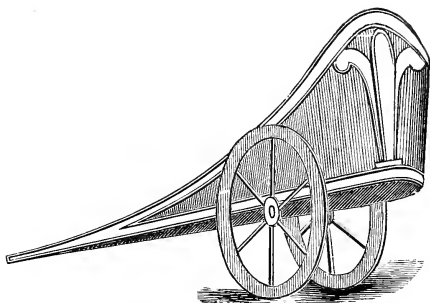

BIGA.—HERCULANEUM.

their Grecian ancestry, the people entertained a like fondness for the

people entertained a like fondness for the

sports of the

sports of the

race - course.

race - course.

Indeed, all

Indeed, all

the more ad-

the more ad-

vanced na-

vanced na-

tions of anti-

tions of anti-

quity appear

quity appear

to have had

to have had

a natural

a natural

weakness

weakness

of this

of this

kind, even

kind, even

going so

going so

far as to

far as to

mingle

mingle

pleasure

pleasure

with the

with the

homage

homage

professedly

professedly

offered to

offered to

the gods,

the gods,

as history

as history

abundantly

abundantly

proves.

proves.

To the fore-

To the fore-

going we

going we

must add

must add

a ludicrous

a ludicrous

exhibition

exhibition

of a

of a

chariot-

chariot-

race of

race of

Cupids,

Cupids,

in stucco,

in stucco,

on the

on the

wall of

wall of

a bath

a bath

at

at

Pompeii,

Pompeii,

of

of

which

which

the

the

illustration

illustration

on

on

next

next

page

page

forms

forms

a

a

part.

part.

The

The

adjuncts

adjuncts

consist

consist

of

of

figures

figures

of

of

Cupid

Cupid

both

both

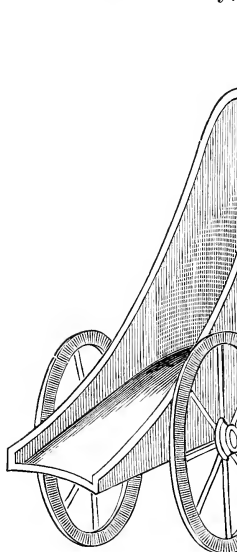

RACING-CHARIOT.—HERCULANEUM.

sports of the
race - course.
Indeed, all
the more ad-
vanced na-
tions of anti-
quity appear
to have had
a natural
weakness
of this
kind, even
going so
far as to
mingle
pleasure
with the
homage
professedly
offered to
the gods,
as history
abundantly
proves.

To the fore-

going we

must add

a ludicrous

exhibition

of a

chariot-

race of

Cupids,

in stucco,

on the

wall of

a bath

at

Pompeii,

of

which

the

illustration

on

next

page

forms

a

part.

The

adjuncts

consist

of

figures

of

Cupid

both

on foot and horseback. In the design much ingenuity is displayed, with the evident intent of producing a subject which would excite laughter in the beholder. An extravagantly long pole, to which

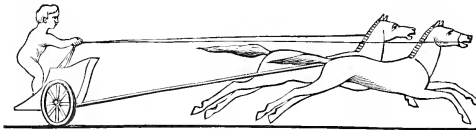

GROTESQUE CHARIOT-RACE.—POMPEII.

exceedingly long-legged animals are hitched, suggests impossibilities in the way of ever winning a prize with such a team. That the Pom-

peiians were accustomed to the race-course is evidenced by the discovery of a circus in fresco, as it must have appeared shortly before the eruption of Vesuvius occurred that buried the city, the amphitheater of which was planted with trees.

In the next figure we have a *plaustrum* which appears to have been in common use. This is taken from a small picture found among the ruins of Herculaneum. The wheels are what is known as *tympanum*, that is, solid. There is nothing peculiarly graceful in this vehicle, yet we are assured that such were employed in carrying passengers, notwithstanding that it has *full wheels*.

Among the ruins of Pompeii thus far, only two examples with four wheels have been found. One is drawn by mules, shown unharnessed,¹ and the other by horses.

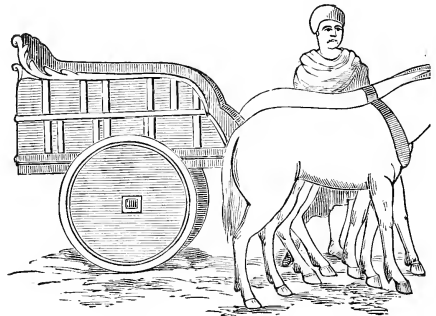

THE PLAUSTRUM.—HERCULANEUM.

This last, minus the horses, is shown in the engraving on next page. This example comes much nearer our idea of what constitutes a perfect vehicle than anything we have produced in this chapter heretofore. It is taken from a painting found in the ante-room of a building in the street of the Lupanare. The original is

¹ See *Musco Borbonico*, Vol. IV, A.

rather slovenly done ; but there is strong evidence that the Pompeians not only used four-wheeled vehicles, but that in design they were not to be despised. An inspection of the drawing will show that a great deal of genuine ingenuity and artistic taste has been displayed in the arrangement of the different parts in their adaptation to practical use.

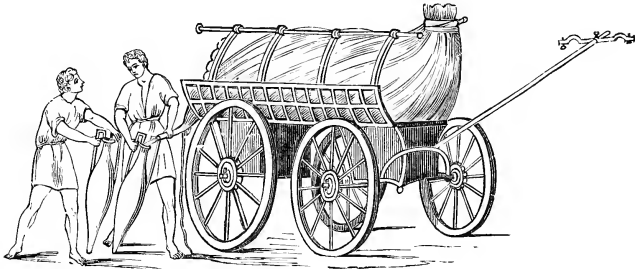

WINE-WAGON.—POMPEII.

The wheels are nearly of a size and very high, — peculiarities fitting them for easy draft. There is a recess in the under side of the body to allow the wheels to pass beneath in turning, and the whole is represented in the painting as being nicely colored, the body in blue and the remainder yellow. The capacious skin, stretched the full length of the body and supported by a well-contrived frame-work, is designed for holding the wine needed for the vintner's customers. Notice how readily the vender fills the long earthen bottle with the precious liquid. This picture undoubtedly represents the wagon and servants of a Pompeian wine-merchant, proprietor of the *Lupanare*, who seems to have dispensed wine in the *thermopolion*, or front shop. The other picture, drawn by mules, found in another chamber of the same edifice, strengthens this opinion, and leads to the conclusion that these were the "show-cards" of an enterprising business man.¹

¹ Among other curiosities, the excavators found on the walls of what may have been a carriage-shop the following notice : "*Otiosis hic locus, non est. Discede, morator!*" (This is no place for idlers. Loafers, clear out!) Near the temple of Juno, of which an account has recently been given, was brought to light a house belonging to some millionaire, the furniture being of ivory, bronze, and marble. The couches of the *triclinium*, or dining-room, are of extreme richness. The flooring consists of immense mosaic, well preserved in parts, of which the center represents a table laid out for a good dinner. In the middle, on a large dish, may be seen a splendid peacock,

Approaching Pompeii from Naples at the time of which we write, both sides of the road, for nearly three miles before entering the city, were occupied by huts and public monuments intermixed with shops. In front of the latter arcades were constructed, affording shelter from the rays of the sun or inclemencies of the weather. The *agger*, or carriage-way, as the road is called, exhibits the worn track or ruts of former years just as distinctly to-day as when first made. These ruts vary from three feet to three feet six inches apart, sometimes four inches deep. The wheels of the chariots seem to have been three inches wide on the tread. In no part allotted to chariots is the way more than fourteen feet, and this has foot-paths, or *margines*, on each side, varying from four to six feet, elevated above the road about twelve inches, and separated therefrom by a curb and guard-stones, raised about sixteen inches, and placed at intervals of from ten to twelve feet asunder. The whole road was paved with lava, in irregular-shaped blocks from ten to fourteen inches thick, originally well joined and put together. Indeed, its state of preservation sufficiently attests the perfection of the principle upon which it was constructed. On these roads, though excellent, travel was comparatively slow. Augustus took two days in going from Rome to Præneste, a distance of thirty-five miles; and Horace took the same time to travel forty-three miles in going from Brudusium, but thinks an expeditious traveler might do it in one day.

In 1239, on the entrance of Frederic II into Padua, the ladies of the highest distinction met him mounted on horses, gayly caparisoned, having nothing better with which to honor him. One of the oldest relics, properly included in this chapter, is the *carroccio*, two poles of

with its tail spread out, and placed back to back with another bird of elegant plumage. Around these are arranged lobsters, one of which holds a blue egg in its claw; a second, an oyster, which appears to be fricasseed, as it is open and covered with herbs; a third, a rat *farei*; and a fourth, a small vase filled with fried grasshoppers. Next comes a circle of dishes of fish, interspersed with others of partridges, hares, and squirrels, which all have their heads placed before their fore-feet. Then comes a row of sausages of all forms, supported by one of eggs, oysters, and olives, which in its turn is surrounded by a double circle of peaches, cherries, melons, and other fruits and vegetables. The walls of the *triclinium* are covered with fresco paintings of birds, fruits, flowers, game, and fish of all kinds, the whole interspersed with drawings which lend a charm to the entire picture not easily described. On a table of rare wood, covered and inlaid with gold, marble, agate, and lapis lazuli, were found *amphoræ* still containing wine and some goblets of onyx.

which, captured from the Florentines in 1260, are now planted near the cathedral at Sienna. This vehicle is described as a very heavy four-wheeled car, surmounted by a tall staff, painted a bright red. On the staff, crowned with a gilt ball, floated in the wind the standard of the city of Florence in the day of its prosperity. Beneath the standard was a large crucifix, and on a platform in front of the car was placed a few of the most valiant soldiers, and on another platform in the rear were the trumpeters and drummers; a priest standing near the crucifix gave absolution to the dying. The car was drawn by four oxen covered with scarlet cloth reaching to the ground. This carroccio is supposed to have been an inferior substitute for the ancient war-chariot, and designed as an emblematical representative both of the Florentine religion and state.

The Italians have claimed for themselves the invention of coaches. This matter we shall consider hereafter. For the present we introduce the *cochio*, which appeared somewhere about 1288, or several hundred years before the reign

of Elizabeth in England. The covering of this singular-looking vehicle, old authors inform us, was red matting, under which, in the fore



ITALIAN COCHIO.

part of the body, the ladies were seated, the gentlemen occupying the rear end. It will be seen, in the progress of this history, that in carriages of this kind this arrangement was generally prevalent among other Continental nations during the next hundred and fifty years.

Sedans, which we shall meet with again in the progress of this work, are noticed by Sandys in his Travels. He says that "the *carrosses* [carriages] is incredible that are kept in this city [Naples] as of the *segges* [sedans], not unlike the horse-litters, but carried by men. These wait for fares at the corners of the streets, as watermen do at our wharves, wherein those that will not foot it in the heat are borne (if they please, unseen) about the city."¹

There are two sedans in the Musée de Cluny, probably Italian, —

¹ Sandys's *Travels*, p. 259, London, 1615.

one with the panels ornamentally painted and gilded, the side moldings being carved. The linings in this instance are green velvet, accompanied with long green fringes pendent from the arm-resters; the other is an extremely light article, having cloth panels painted a blue color, the cushions being velvet.

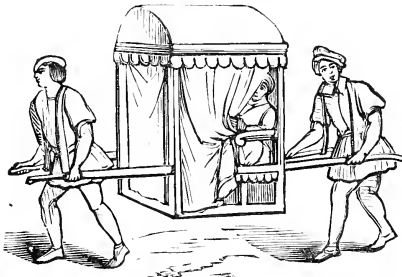

NEAPOLITAN SEDAN.

Strangers on their first visit to Naples are surprised at the immense number of

carriages found dashing through the city in all directions, although the citizens generally are supposed to be poor. The fact is, every Neapolitan who aspires to the rank of *gentleman* thinks it indispensably necessary to keep some sort of an equipage, even should he pinch himself in other points of domestic economy. Even the poorer class have a passionate fondness for riding, which they gratify to a great extent by clubbing together and hiring carriages for Sundays and the holidays, which occur as often as once in a fortnight. Among these vehicles are the extreme in quality from good to bad, driven at a fearful pace along the lava-paved streets, the rattling of which might be thought the perfection of noise, were it not in some degree drowned by the shouts of the motley drivers bawling out their rates of fare. There are four classes of hack vehicles in Naples: the *canestra* or *carettella*, the *corribolo*, the *flower-pot calesso*, and *il calesso*. The first is similar to our barouche, the second is a sort of cab, and the third a nondescript unlike any other carriage in our nomenclature, — the section of a flower-pot divided perpendicularly into two parts, and fastened to a wooden axle-tree, on which the wheels revolve, without skeins or hub-boxes. The last-mentioned is the most popular vehicle, — the carriage of the people.

The calesso, though less stylish than the corribolo and the flower-pot, is capable of carrying more passengers, and is in more respects than one considered the omnibus of the Neapolitans. With some ingenuity, and sacrifice of comfort, a corribolo may be made to carry four besides the driver, and so indeed may a flower-pot; but the

calesso may on a pinch carry a round dozen. So far from being rare, it is a common thing to see a rickety machine, with three men and women — one probably a fat priest — on a seat, and two or three more on their laps, or sitting in the bottom, with some of their legs dangling in front of the wheels; three more hanging on behind; a boy or a sturdy lazzarone seated on the shafts, and a couple of small children slung in a net beneath the axle-tree; to which must be added the driver, who either stands erect amid the passengers behind, flourishing his whip over the heads of those within, or else sitting in front on the shafts, with his legs hanging over the side. The oddest thing attached to a calesso is the net with the children, and the multitude of legs dangling on all sides. A traveler gives us the following picture of what he saw on the road to Pompeii: As he approached a wine-shop by the roadside, he "saw a calesso turn and drive back at speed, and on getting nearer saw a female peasant, dressed in gala clothes, tearing her hair and beating her bosom in a fearful manner. What was the matter? The calesso, crowded as usual on such occasions, was going to a *fiesta*, or fair, at the town of Nocera d' Pagani, and on stopping at the wine-house to refresh, it was discovered that the net below with a little boy in it was missing. The rope that held it had given way, and as the festive party were probably (as is usual with them when exhilarated by riding) all singing at the tops of their voices, the cries of the child were never heard. The afflicted mother was sure the *guaglioniello* was killed; but presently a joyful shout was heard along the road, and the calesso, returning in company with another, brought back the little urehin, covered, indeed, and almost choked with dust, but otherwise safe and sound."

This calesso is generally drawn by two horses, one inside and another outside the shafts, harnessed in the rudest manner with ropes, very little leather being seen. Some of these vehicles are furnished with a top of untanned hide, which is spread over the heads of the "insides," but there are no springs beneath the body, it being hung off on thorough-braces of leather. The driver, who is usually a man of some humor, considers it a part of his duty to amuse his passengers, as well as for his pecuniary interest. On holidays these calessos are set off with branches of trees, flowers, etc., which, added to the gaudy dresses of the occupants, make the turnout look sufficiently gay and pleasing to the beholder.

CHAPTER VII.

CHINESE, INDIAN, AND TARTAR CARRIAGE REPOSITORY.

“ A city where the world does not run on wheels is commercially dead.

ANON.



ALTHOUGH the Chinese claim for their empire great antiquity, still they have very few land-carriages, owing to the many riv-

ers and canals which intersect it, making water conveyance more convenient and much more economical. The Chinese sometimes travel on horseback, but it is said the riders grudge the animals the proper amount of food, and they are consequently miserable, stunted creatures. Their best mode of traveling is in a sedan-chair, the streets of some cities being so narrow that even this has to be set down at the gate, while the visitor pursues his journey on foot. Upon the shoulders of two bearers the poles are placed, which are extremely elastic, in shape like the shafts of a gig. As the bearers move forward with a measured step, the motion is almost imperceptible to the occupant. Instead of panels, the sides and back of the chair consist of woolen cloth for the sake of lightness, with a covering of oil-cloth against rain. The front is closed by a hanging-blind of the same material, in lieu of a door, with a circular aperture of gauze to see through. Private individuals are restricted to two bearers, ordinary magistrates to four, and the viceroys to eight, while the emperor alone is great enough to require sixteen!

It will readily be seen from the preceding remarks that two-wheeled vehicles are the most appropriate for China. Consequently the cab, which accompanies the initial letter to this chapter, finds most favor in the eyes of the natives. To a stranger the jolting in these cabs is very annoying on rough roads, there being no springs attached to them, but on a good road they answer tolerably well, the mules or ponies scarcely requiring a whip, having been so skillfully educated that they perfectly well understand the driver. It is astonishing how the Chinese manage their diminutive animals by kindness. Refractory mules, which could not be induced to go into the shafts by threats, are as obedient as dogs at a word from a Chinaman. Some of these cabs are handsomely finished, although clumsily constructed.

We are told that in the eleventh century the Chinese had shown some ability in the construction of vehicles. Drawings of those used by the ancient rulers in their festivities, made by native artists, have been preserved. These have something of an antique appearance, but are of simple construction, drawn by four horses abreast. In the vehicle sits an emperor, an officer of second rank, whip in hand, driving, while the coachman holds the reins. The emperor is seated on the left or near side, that being the place of honor among the Chinese. The functions of the royal coachman were then of much consideration. Some of the king's carriages had but two wheels, while others

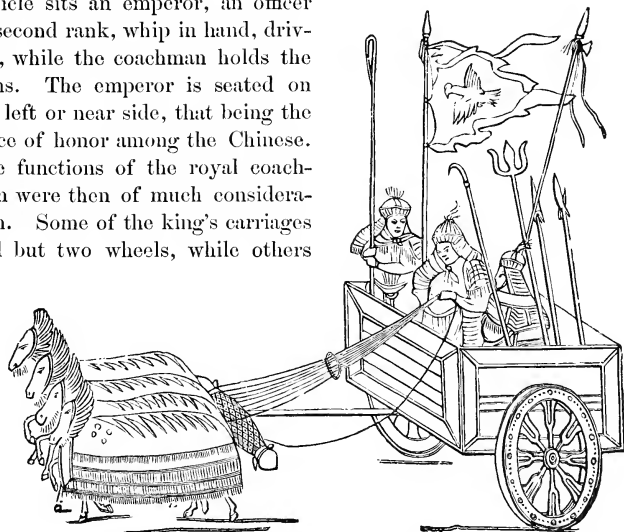

ROYAL CART, BY A CHINESE ARTIST.

had four. They were entered at the front, this part of the carriage being frequently covered with the skin of a tiger or some other wild animal.

The next drawing represents the emperor's coachman seated in another carriage, in royal livery, perhaps in the discharge of some special duty in his sovereign's service. The wheels of these vehicles—as, indeed, are all made in the Celestial kingdom—have an unusually heavy set of felloes, giving

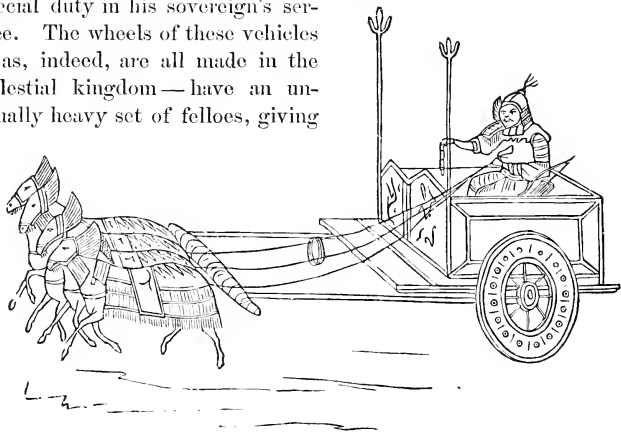

COACHMAN OF THE EMPEROR OF CHINA.

them a look of solidity very deceptive.

"The ancient sovereigns of China," Guignes tells us, "had still another carriage, which they call *tching*. It was drawn by sixteen horses, which fact served to show its superiority. They also used this word to distinguish the house of a prince, by the expression of one hundred sixteen-horse chariots (*pe-tching*), a prince not being allowed by law to own more than sixteen hundred horses. For the same reason one thousand sixteen-horse chariots (*tsien-tching*) designates the royal house. In those ancient times, eight hundred families of the community were obliged to furnish one sixteen-horse chariot, with three captains, equipped with casque and shield, and twenty-two foot-soldiers."

It is but recently that a railway, running from Woo-sung to Shanghai, has been laid, from the terminus of which a single omnibus of European construction carries passengers to different parts of the city.

There is a vehicle in Japan called a *jin-eik-sha*, which Bishop Wiley says looks very much like a large American baby-wagon. It is generally used for travel by the natives, and is a special favorite with visitors to that country. It is drawn by men instead of horses at an exceedingly quick pace, at an expense of about ten cents an hour. They are described as being very easy and pleasant to ride in. The carts on the streets have pauc-wheels in the primitive fashion, cows taking the place of horses as beasts of burden.

Much of the travel in India is by palanquins, borne either by men or on the backs of elephants. There is, however, a limited number of carriages, generally of rude construction, judging from the display of models seen by the writer in one of the rooms in the Museum, South Kensington, London, on our visit there in 1873. Some of these carriages are known as the *tonga*, *hecca*, etc., all of which have



INDIAN HECCA.

wooden axle-trees. Formerly the prejudices of the natives against animal fat stood in the way of greasing, consequently when on the move they were apt to be more musical than otherwise entertaining either to man or beast. Under British rule, however, the people have been compelled to use olive-oil, which has, in some degree at least, improved matters.

On the preceding page is an engraving of the hecca, or hack-cart, in which, sitting tailor-fashion, is seen a *baboo*, or writer, on his way to his *kutchery*, or office. This kind of vehicle is not the most easy in which to ride, as it is hung off to some disadvantage without springs. The motion imparted to the vehicle by the movements of the horse in the shafts adds much to the passenger's misery, as it occasionally carries his feet in close proximity to the driver's head. Even the driver is in peril of his life, perched as he is in a dangerous position over the heels of the horse, liable at any moment to fall under the ponderous wheels.

One of the most useful vehicles in India is the *Gujerat village-cart*, employed in agriculture. Without so much as a single mile of made road in the whole country, these carts, made to track so as to fit the ruts exactly, move as if on rails, drawn about from village to village by one or two pairs of bullocks, carrying heavy and bulky loads,

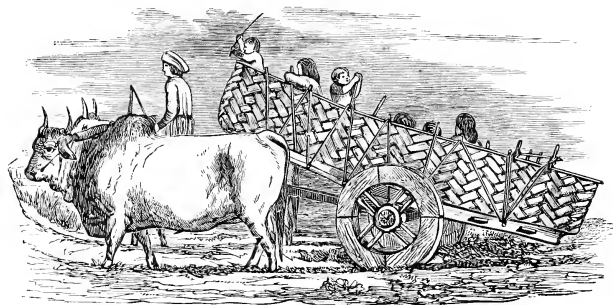

GUJERAT VILLAGE-CART.

weighing from twelve to eighteen hundred pounds. These carts are all built after a fixed model. The frame and other portions are all strongly mortised and fastened by wooden pins, the pole extending from the axle-tree to the yoke by which the bullocks draw the vehicle. The pole is formed of two pieces of tough wood running separate from or near each of the wheels, uniting in front in a point, acting as a powerful lever in turning or moving the cart. Round about, and forming the side of the cart, there is attached by ropes a plaited basket-work, made of cotton-plant stalks.

The wheels are the most important parts of the whole, exhibiting some degree of mechanical skill in their construction. Four equal-sized segments of the hard wood of the *acacia arabica* tree are contained in the rim, which is four inches broad at the tread, forming a circle of from four to five feet diameter. The axles are iron, working in wrought-iron boxes. It is very rare to find iron nails used in fastening the different pieces together, but the mortising is so skillfully done that these carts last for years.

It will be seen that in the picture the feet of the bullocks are not visible, owing to the fact that they walk in the ruts made by the wheels. This they must do; and the whole secret of the facility and speed with which they travel depends on this. The ruts, when once formed, remain as permanent roadways, particularly in the black cotton soil. They are about five inches wide and as many deep. Very little care is taken to preserve these ruts. The earth itself becomes so hard in the dry season (and it is only then these carts are used) that a little filling in of loose earth occasionally by the poor villagers, in places too deeply worn, is all the repairing needed. For this labor the workmen get a few *pie* from the cartmen, with which they are content.

There is a bullock-transit carriage in India, mounted on four wheels, hung off on heavy springs, with an arched double roof, the interior of which is six feet long, three wide, and four high, with windows in the sides and ends furnished with blinds inside and sun-shades on the outside. A projecting roof in front protects the driver against rain and the sun's rays. The entrance is from the rear. Within the carriage are a number of pockets for holding water and "spirits," which some think refreshing. A netting overhead serves for the stowage of blankets, books, etc. About a foot above the fixed floor is a movable one of boards laid crosswise, beneath which baggage is stowed, and on which a mattress is laid, several small pillows for the head, and packing around the sides protects the knees, elbows, etc., against bruising, as the passenger is driven over rough roads. Here he can stretch himself at ease, and when tired of reclining has only to throw back one end of his bedding, take up two or three boards of the movable floor, put his feet in the opened space, and then with the bedding at his back ride in comfort. The rate of travel is from four and a half to five miles the hour, with relays at the end of every four miles.

Traveling night and day, these carriages make from ninety to one hundred miles in the twenty-four.

The car of Juggernaut is too important to be omitted in this collection. A late traveler thus notices it: "At the beginning of the rain season, which is in June, . . . then comes the grand procession. The car is twenty feet high, constructed like a pyramid, and is twenty feet square. It is mounted on twenty-four wheels, each wheel four feet in diameter and more than a foot thick. These wheels are arranged in three rows, eight wheels in a row, and placed two feet apart, so that whoever falls under them is crushed. The exterior of the car is elaborately carved, and on a curtain is painted a picture of the procession. At the front of the car are two wooden horses, and on either side are the images of men and women. Upon this the owl-like image of Juggernaut is placed, amid the sound of conch-shells and the shouts of the multitude, and a hundred thousand people struggle with each other for the privilege to draw the 'infernal machine.' In the excitement which follows, some fall beneath the wheels and are crushed to death, while the more fanatical deliberately throw themselves beneath the ponderous car, hoping thereby to merit heaven."

According to Justin, the Scythians as a nation were ignorant of the arts and sciences.¹ A much older authority says, "They neither have cities nor fortifications, but carry their houses with them, who are all equestrian archers, living not from the cultivation of the soil, but from cattle, and whose dwellings are wagons."² The country is represented as being so cold in the winter, and the Cimmerian Bosphorus freezes so hard, that the Scythians "lead their armies and drive their chariots over the ice to the Sindians on the other side."³ These "barbarians," as they were called, like their successors the Tartars, built their houses

¹ "Uxores liberosque secum in plaustris vehunt quibus coriis imbrium hyemsque causa tectis, pro domibus utuntur."—JUSTIN, B. II, ch. 2.

"Campestras melius Scythæ,
 (Quorum plaustra vagas rite trahunt domos)
 Vivunt; et rigidi Getæ;
 Immetata quibus jungera liberas
 Fruges et Cererem ferunt;
 Nec cultura placet longior annua,
 Defunctumque laboribus
 Æquali recreat sorte vicarius."—HORACE, B. III, Ode 24.

² Herod., B. IV, 46.

³ Herod., B. IV, 28.

on wheels, but likewise had rude carts and even wagons. Indeed, Taylor says "their habitations were nothing but coaches"; that "from these people our coaches had first original"; and that "with them the world runnes on wheeles continually."¹ These movable houses were differently constructed. One kind consisted of a strong flat floor, on the sides of which poles were inserted, and round these the skins of animals were drawn, rendering them very comfortable for

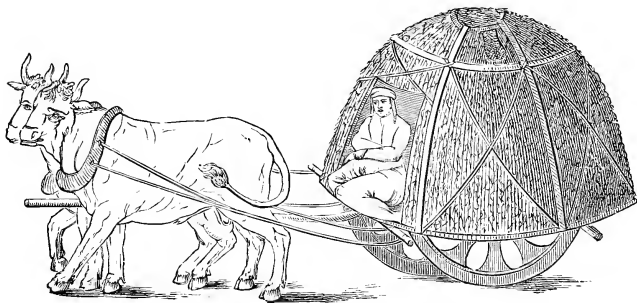

SCYTHIAN HOUSE ON WHEELS.

dwelling. On some the poles or bows were arched, and when a matting was spread over them they looked like an old-fashioned bee-hive made of straw; when these moved over the plains in columns, they presented a very picturesque and interesting sight — in the distance. The hoop-sticks before mentioned as arched over the body, supporting the covering, all entered the flooring at the ends, except two at the sides (one on each side), which being brought down over the wheels, held all secure. A space left open in front answered the purpose of a door. In these the women lived, following their domestic employments. Herodotus tells us that some Amazonian females interposed this mode of habitation as an objection to their living in Scythia as the wives of certain men of that country who offered them marriage.²

The axles of these vehicles were usually made of oak, and to these the body was rudely fastened by cords, twigs, or wooden pins, no metal of any kind being used. For many centuries, in carriages thus constructed, long and comparatively rapid journeys were made; and

¹ See *The World runnes on Wheeles; or, Oddes betwixt Carts and Coaches*, p. 17.

² Herod., B. IV, 114.

so slight has been the effect of time in altering this ancient kind of

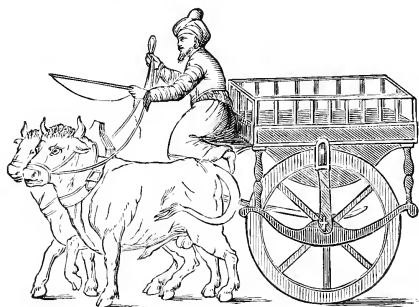

TARTAR CART.

mechanism, that similar vehicles have been described as not uncommon in our day among their successors the Tartars, and the natives of some of the more southern parts of Russia, where it might have been expected that modern improvements would have suggested greater progress. A child's cradle seems to have fur-

nished the pattern for the cart, of which we give an illustration, the rockers serving as goose-necks in hanging up the body. These rockers, after being slipped on the ends of the axle-trees, had an upright added to strengthen the structure, both being held in place by lynch-pins. The harness is of the most primitive kind, and very simple.

In the punishment of condemned false prophets, a singular custom was observed. Herodotus says, "When they [the Scythians] had filled a wagon with fagots, and yoked oxen to it, having tied the feet of the offenders and bound their hands behind them, and gagged them, they enclosed them in the midst of the fagots; then having set fire to them, they terrify the oxen and let them go. Many oxen, therefore, are burnt with the prophets, and many escape very much scorched, when the pole is burnt asunder."¹

The funeral ceremonies of this rude people deserve mention. At the death of a subject, his body was laid in a chariot, and carried by the nearest relatives about among their friends, the attendants and the dead body all having the like attentions paid them for forty days, after which the body was buried. But when the king paid the debt of nature, they went through certain prescribed ceremonies for a year, when fifty of his choicest servants and fifty of his finest horses were strangled, these last disemboweled, and, the cavities being stuffed with chaff, were then sewed up. "Then having placed the half of a wheel,

¹ Herod., B. IV, 69-73.

with its concave side uppermost, on two pieces of wood, and the other half on two other pieces of wood, and having fixed many of these in the same manner, then having thrust thick pieces of wood through the horses lengthwise up to the neck, they mount them on the half-wheels; and of these the foremost part of the half-wheels supports the shoulders of the horses, and the hinder part supports the belly near the thighs, but the legs on both sides are suspended in the air; then having put bridles and bits on the horses, they stretch them in front, and fasten them to a stake; they then mount upon a horse each one of the fifteen young men that have been strangled, mounting them in the following manner: when they have driven a straight piece of wood along the spine as far as the neck, but a part of this wood projects from the bottom, they fix it into a hole bored in the other piece of wood that passes through the horse. Having placed such horsemen round the monument, they depart.”¹

The Tartars in modern times do not show much improvement. “The oxen and horses are small and poor, and, judging from their vehicles, one would conclude that mechanical ingenuity could not be a prominent element in the composition of this people, for the first maker of wheels could not have contrived them with joints farther apart than those of the Tartar wagons, or have succeeded in getting them further from a circle, unless he had premeditated an octagonal.”² When on the move they make such a horrid creaking that the sound thereof has become proverbially “Tartar music.”

¹ Tacitus, *Germ.*, ch. 46.

² Ditson's *Tour to the Caucasus*, p. 125.

CHAPTER VIII.

FRENCH CARRIAGES, INCLUDING HISTORICAL ASSOCIATIONS.

“Champs Elysées ; time, past five ;
There go the carriages — look alive !
Everything that man can drive,
Or his inventive skill contrive —

.
Dog-cart, droschke, and smart coupé,
A disobligeante quite bulky,
French idea of a Yankee sulky.”

BRET HARTE'S *Tale of a Pony.*



THE Gauls, “in their journeys and flights,” says an old historian, “use chariots drawn with two horses which carry a charioteer and soldier, and when they meet

horsemen in the battle, they fall upon their enemies with their *sauni-ans* [a kind of dart] ; then quitting their chariots, they rush to it with their swords. There are some of them that so despise death that they fight naked, with something only about their loins.”¹ We conclude that, as among other rude nations of ancient times, the vehicles were chiefly war-chariots, although it appears from history that the Gauls did have rude wagons of various kinds suited to their agricultural pursuits. What these were is now unknown, and it would be folly to speculate where so much ignorance prevails. We only know that the

¹ Diod. Siculus, B. V, ch. 2.

introduction of carriages into Europe is claimed by Italy, France, and Germany alike, and perhaps with equal pretensions.

Rees, in his *Encyclopædia*, tells us that, "Some have thought from the etymology of the word *coach* to determine the country in which it was invented; but it would be much easier to ascertain the origin of the term, did we know by whom close carriages were invented. Menage makes it Latin, and by a far-fetched demonstration traces it from *vehiculum*. Junius derives it from *οψεω*, to carry. Watchler seeks its origin in the German word *kutten*, to cover; and Lye, in the Belgic *koefsen*, to lie along, as it properly signifies a couch or chair. Others endeavor to prove that the word is of Hungarian extraction, and that it had its rise from a village in the province of Weisberg, which is at present called Kitsee, but was formerly known by the name of Kotsee, or Kotzi, and that this traveling machine was even there invented. However this may be, it is certain that in the sixteenth century, or even earlier, a covered carriage was known under the name of Hungarian carriage."

Carriages, as we have shown, have always existed in some form since the days of the Pharaohs, and with the progress of civilization have increased and improved among different nations. It is true that in the darker ages they seem to have nearly disappeared; but with the revival of intelligence they reappear again in new forms, suited to diversified tastes, until, as we find in our day, they are almost innumerable.

As early as 1294, by a public ordinance of Philip the Fair for suppressing luxury, citizens' wives were forbidden to use carriages, under severe penalties,¹ but this restriction was not long continued. In the "*Anciennes Chroniques de Flandres*" is an illustration of the flight of Emergard, wife of Salvard, Lord of Rousillon, which is probably the oldest representation of a Gallic carriage extant. The lady, according to an ancient custom, sits sideways in her seat, accompanied by her two attendants, one probably a waiting-maid, the other the "fool of quality." The body is ornamented with carved figures, the side

¹ "Premibrement nulle bourgeois n'aura char." And again, "Les voitures sont plus modernes qu'on ne l'imagine communement. L'on n'en emploïoit que deux sous François I, l'une a la reine, l'autre a Diane fille naturelle de Henri II. Les dames les plus qualifiées ne tarderent pas à s'en procurer: cela ne rendit pas le nombre d'equipages fort considerable." — *Encyclopædia*.

curtains, covering a bow-top, being nicely rolled up. This "charriette," or whatever



ANCIENT FLEMISH CARRIAGE.

called, was drawn by two horses, guided by a mounted postilion. The paper from which our engraving is taken is dated 1347, and may be found in the British Museum.¹

Long after this litters and sedans² were in common use among Continental nations. As early as 1399, Isabella of Bavaria made her entry into Paris in a litter. This seems to have been used by ladies exclusively. An old chronicler thus relates the entry :

"On Sunday, the twentieth day of June, in the year of our Lord 1399,

there were such crowds of people in Paris it was marvelous to see them ; and on this Sunday the noble ladies of France, who were to

¹ See MS. *Reg.* 16, F. III, fol. 11, 70.

² In the valley of the Meuse, France, is a town called Sedan, which has been rendered famous by the surrender of Napoleon III to the army of Prussia in the late war. It is likewise noted as the birthplace of Marshal Turenne, and furthermore, a correspondent of the New York *Tribune* says, "It is also known as the place where sedan-chairs originated." This last assertion will undoubtedly raise a smile on the countenance of the reader at the absurdity of the writer.

accompany the queen, assembled in the afternoon at Saint Denis, with such of the nobility as were appointed to lead the litters of the queen and her attendants. The citizens of Paris, to the number of twelve hundred, were mounted on horseback, dressed in uniforms of green and crimson, and lined each side of the road. Queen Joan and her daughter, the Duchess of Orleans, entered Paris first, about an hour after noon, in a covered litter, and, passing through the great street of Saint Denis, went to the palace, where the king was waiting for

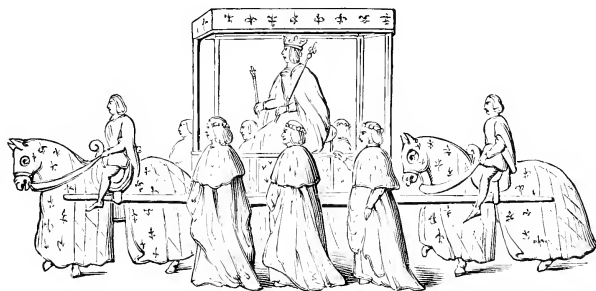

LITTER.—ISABELLA'S ENTRANCE INTO PARIS.

them, and this day they went no farther. The Queen of France, attended by the Duchess of Berry, the Duchess of Burgundy, the Duchess of Touraine, the Duchess of Lorraine, the Countess of Nevers, the Lady of Coucy, with a crowd of other ladies, began the procession in open litters most richly ornamented. The Duchess of Touraine was not in a litter, but, to display herself the more, was mounted on a palfrey magnificently caparisoned.

"The litter of the queen was led by the Dukes of Touraine and Bourbon at the head, the Dukes of Berry and Burgundy were at the center, and the Lord Peter de Navarre and the Count d'Ostrevant behind the litter, which was open and beautifully ornamented. The Duchess of Touraine followed on her palfrey, led by the Count de la Marche and the Count de Nevers, the whole advancing slowly, at a foot's pace. After her came the Duchess of Burgundy and her daughter, the Lady Margaret of Hainault, in an open litter, led by the Lord Henry de Bar and Sir William, the young Count de Namur. Then came the Duchess of Berry and the daughter of the Lord de Coucy, in

an open and ornamented litter, led by Sir James de Bourbon and Sir Philip d'Artois. Then the Duchess de Bar and her daughter, led by Sir Charles d'Albret and the Lord de Coucy. There was no particular mention made of the other ladies and damsels who followed in covered chariots, or on palfreys, led by their knights. Sergeants and others of the king's officers had full employment in making way for the procession and keeping off the crowd, for there were such numbers assembled it seemed as if all the world had come thither."¹

Such was the effect of prejudice on the public mind at this time (1399) that very few ladies could be prevailed upon to relinquish riding on horseback for traveling in litters, although encouraged by the example of royalty. It required nearly three centuries to remove it. As late as 1650 there were still to be seen in the streets of Paris the stone benches placed there for the convenience of its citizens in mounting on horseback.

After these litters borne by men came the horse-litter. In the engraving — copied from a manuscript history of the Kings of France, written at the beginning of the fourteenth century, preserved in the British Museum — we find the picture of one. It represents the removal of Queen Clotilde in her last sickness to Tours, where she died. This litter is supposed to have been furnished with a bed and

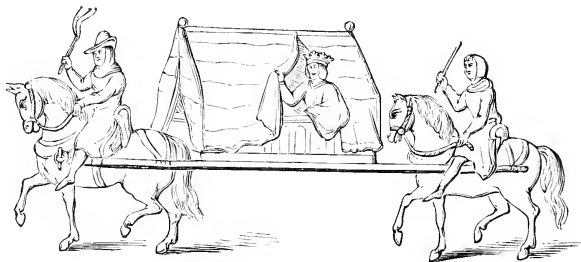

FRENCH HORSE-LITTER.

cushions, and curtains opening at the sides represented as yellow, striped with red. This kind of litter is said to have been used only in cases of sickness or by ladies; the Norman knights, who prided themselves on their horsemanship, considering them disgracefully effeminate.

¹ Froissart's *Chronicles*, Vol. IV, ch. 2.

During the fourteenth, fifteenth, and some portions of the sixteenth centuries, the men preferred — that mode of conveyance being the most fashionable — to travel on horseback, even when they had to ride double. Men of the first rank frequently sat behind their equerry, and the horse was often led by servants. When Charles VI of France wished to see, *incognito*, the entrance of the queen into Paris, he placed himself on horseback behind Savoisy, who was his confidant, with whom, however, he was much incommoded in the crowd. When Louis, Duke of Orleans, that prince's brother, was assassinated in 1407, the two *ecuyers* who accompanied him rode both on the same horse. Ladies also frequently appeared on horseback upon public occasions, for although carriages of some kind existed, they were as yet by no means commonly in use.

We are informed by Roubo that "modern carriages are extremely new in France, as all our princes either walk or ride on horseback, and so do ladies even, except when traveling long journeys, which then were either made in litters or covered chariots,"¹ — the latter a kind that was not used in the town. This is so true that in the year 1457, in the reign of Charles VII, the ambassadors of Ladislaus V, King of Hungary and Bohemia, offered to Marie of Anjou, the Queen of France, with other gifts, a chariot which was very much admired by the court and the people of Paris, because, as a historian of that period says, it was "wabbling" and richly molded, and that the chariots then in use were not "hung up, but set directly upon the axle-tree."

The progress of art at this period was very slow in Continental Europe. The representation of a chariot in use by royalty on state occasions is annexed. It is copied from a very scarce French work entitled "*Le Roman du Roy Meliadus*," preserved in the manuscript department of the British Museum. This is supposed to have been written in the latter half of the fourteenth century, but the references in the text to the chariot shown are somewhat obscure. In this chariot the king is seated with his helmet placed beside him, having also a

¹ We are informed by an old dictionary that the word "chariot" comes from the French, which primarily meant a wagon, and was also applied to a kind of litter borne up by an axle-tree on two wheels, used by citizens' wives who were not able or not allowed to keep ordinary litters. Hence by degrees it became applied to the vehicles to which it is now peculiarly appropriated. (See Cottgrave's *Dictionary*, 1632.) The term "chariot" was likewise applied to a war-engine in some portions of the continent of Europe. (See *Antiquarian Repertory*, Vol. III, p. 360.)

cushion for resting his royal head upon when he chose to use it. The wheel, "which is more ornamental than useful," reminds us of those

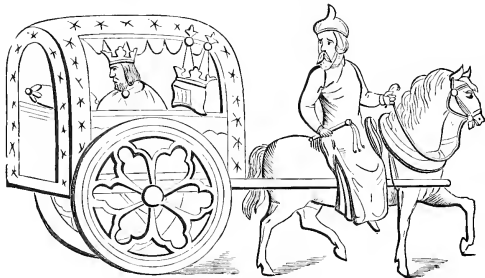

FRENCH STATE CHARIOT.

curiosities called windows in ancient churches of the time. The Spanish and French custom of placing the postilion on the horse, as here seen, is said to have been caused by the fact that the Duke of Orleans on one occasion had a state

secret divulged by his coachman, who sat near him when traveling.

In 1474 the Emperor Frederick III is reported to have visited Frankfort in a close carriage which seems to have effectually sheltered him from the rain; but whether the top was a temporary fixture, or, like the last, stationary, is uncertain. Roubo, to whose labors we are indebted for much of our knowledge, says, "It was as late as under the reign of Francis I [1515-1547] that a kind of carriage called 'carrosses' were used in France, but the exact form of them is unknown. These carriages would seat two or four persons, but were very scarce, there being only two in France,—one the property of the queen, the other of Diana, natural daughter of Henry II.¹ It was not until during the reign of Henry the Great [1572-1610] that the use of carriages became more common."² Later, in 1509, the Electress of Brandenburg, the Duchess of Mecklenburg, and some others displayed elegant carriages. The Elector of Cologne (1562) had several, and the Margrave John Sigismund at Warsaw (in 1594) had no less than thirty-six carriages, with six horses to each, concerning which it

¹ "Some historians tell us that there were three carriages in Paris, — one belonging to the queen, the second to Diana de Poitiers, the third to René de Laval, Lord of Bois Dauphin, who was such a corpulent and unwieldy gentleman as to be unable to ride on horseback. Others say that the three first carriages belonged to Catharine de Medici; Diana, Duchess of Angouleme, who died in 1619; and Christopher de Thou, first president of the Parliament." — REES'S *Ency.*, Art. "Coach."

² *L'Art du Menuisier*, by Roubo, p. 457, Paris, 1771.

is recorded that "the common use of carriages is not older than the time of John Sigismund."¹

In 1527, when Wolsey visited France, the dame regent, the king's mother, entered Amiens "riding in a very riche chariot," and with her therein was the Queen of Navarre, her daughter, furnished with one hundred or more ladies, some in rich horse-litters and some in chariots.² The king, though attended with the utmost magnificence, according to the military spirit of the age, rode into the city on "a goodly genet."

According to Duiman, in a tract entitled "Sur la question que doit-on à l'Espagne" (p. 38), the Spaniards first invented coaches; and Twiss, in his account of Spain (p. 324), says the first coach was made use of in that country in 1546.³ Macpherson, in the "Annals of Commerce," states that as early as 1650 there were five hundred coaches in Antwerp, used by persons of distinction.⁴ The custom of riding in carriages seems to have become general, in spite of Duke Julius's proclamation.⁵

Henry IV of France is said to have had but one coach for himself and wife, an engraving of which is annexed. In this he was assassinated, in the Rue de la Ferromerie, Paris, May 14, 1610, by Francis Ravallac. As springs had not yet been invented, this was rather an uncomfortable carriage. As was the custom of the times, the doorway had an ornamental piece of leather drawn across it, as shown in the illustration. When required, curtains were sus-

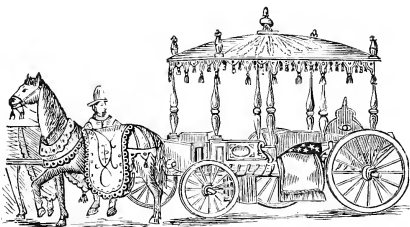

COACH OF HENRY IV OF FRANCE.

¹ *Suite des Mémoires pour servir à l'Hist. de Brandenbourg*, p. 63.

² Wordsworth's *Eccles. Biog.*, I, 389.

³ Father Smedl states that the Italians obtained coaches from China. (See Sir George Staunton's *Embassy to China*, Vol. II, 75.) In a French Encyclopædia, Tome IV, Art. "Carrosse," we find, "Les carrosses sont de l'invention des François, et par conséquent toutes les voitures qu'on a imaginées depuis a l'imitation des carrosses," thus crediting the French with the invention.

⁴ *Annals of Commerce*, II, 133.

⁵ Lunig., *Corp. Jur. Feud. Germ.*, II, p. 1447.

pended from the roof of the carriage as a protection to the passengers.

Early in the sixteenth century covered carriages appear to have been used by ladies of high rank, while as yet the men considered it unbecoming in them to indulge in such luxuries, unless as the ambassador of a foreign nation. Such for the first time were seen in a coach at the imperial commission at Erfurth in 1613. The wedding-carriage of the first wife of the Emperor Leopold, a Spanish princess, cost with the harness thirty-eight thousand florins. The coaches used by that emperor are thus described by Kink: "In the imperial coaches no great magnificence was to be seen; they were covered over with red cloth and black nails. The harness was also black, and in the whole work there was no gold. The panels were of glass, and on this account they were called the imperial glass-coaches. On festival [occasions] the harness was ornamented with red silk fringes. The imperial coaches were distinguished only by their having leather traces, but the ladies in the imperial suit were obliged to be contented with carriages the traces of which were made of ropes."¹ Still later (in 1681) there was a magnificent display of carriages in Hanover belonging to the Duke Ernest Augustus, who had fifty gilt coaches, with six horses to each.

Some idea of the rude carts used in Picardy at the beginning of the seventeenth century may be formed from the annexed engraving, copied from "Coryat's Crudities,"² published in 1611. Making ample allowance for the self-styled "Odecombian leg-stretcher's" sketches, it is still evident that art as yet had done but little for the people. The body is ungainly even for a cart, and the head-covering is of the rudest kind.

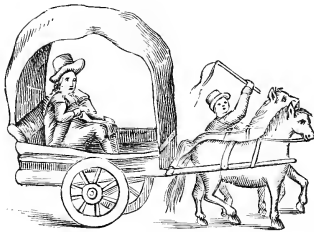

PICARDY CART.

¹ Luning's *Theatr.*, Cer. I, p. 289.

² "Coryat's *Crudities*, hastily gobbled up in five moneths travells in France, Savoy, Italy, Rhetia, Commonally called the Grisons Country, Helvetia, alias Switzerland, some parts of High Germany, and the Netherlands: newly digested in the hungry aire of Odecome, in the County of Somerset, and now dispersed to the nourishment of the travelling members of this Kingdome, &c. London: Printed by W. S., Anno Domini,

The figures of four ancient carriage-bodies have been preserved in "L'Art du Menuisier," two of which, Siamese-twin fashion, we here introduce to our readers on a reduced scale. These vehicles appear to have had stationary heads, which were furnished with curtains removably at pleasure. Roubo tells us "these carriages were called *coches*, these being the only kind of vehicles of which we know the exact form." The author above mentioned says some of these coaches were extant in his time. Much splendor was aimed at in the construction, by the use of rich carvings, monograms, and coats-of-arms, — "airy nothings" frequently employed in *dignifying* many of the meanest specimens of humanity that ever breathed.

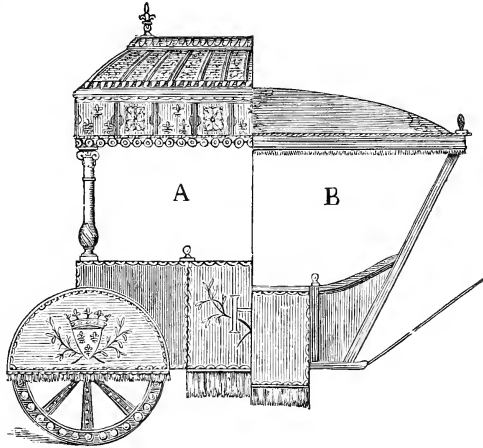

ANCIENT TWIN CARRIAGE-BODIES.

Historians tell us that hackney-coaches were introduced into Paris in 1650 by Nicholas Savage, which is probably true; but when they ask us to consider him the inventor, we question their position.¹ From the first they were called *fiacres*, some writers say because the image of a saint of that name was painted on the panels, others because the inventor resided at the Hotel St. Fiacre, located in Rue St. Martin, opposite Rue St. Montmorency. Probably they were so called in compliment to the saint of that name, who is said to have been born

1611." Coryat died at Surat, on a second journey, aged forty, in December, 1617. *Sic exit Corygatus*.

¹ The claim for Savage is made exceedingly doubtful by a letter in Stafford's *Collection*, under date of April 1, 1634, wherein it is recorded that hackney-coaches were then to be hired in London, at the May-pole in the Strand, with which everybody was much pleased: "For whereas before coaches could not be had but at great rates, now a man may have one much cheaper."

in Ireland — a land prolific of them — about the year 600. He went to France at the invitation of the Bishop of Meaux, where he founded a hospital for travelers and the poor. This establishment was sometimes called the Holy Fiacre. In the pursuit of duties connected therewith, he is reported to have established the first hacks, to be used in transporting the needy and infirm to his hospital. These in time were known as *fiacres* (sacred carriages), because they were used in charitable offices. Similar vehicles afterwards being used for carrying the public, the appellation was extended to all such conveyances. The 30th of August is St. Fiacre's day among the Parisian hackmen, many of whom are ex-priests, who are admitted to be more intelligent and honest than the same class in other cities. On the day of celebration, the fraternity have "a good time" in singing, feasting, and dancing, the denizens generally enjoying the privilege of going afoot for the benefit of his saintship.

The following engraving represents the fiacre of former days, designed for carrying six inside passengers, two sitting in the doorways facing outward. Like other vehicles of the time, it is guiltless of springs and suggestive of penance. The so-called half-doors were merely curtains closing the entrance. The wretched condition



PARISIAN FIACRE.

of the roads and the imperfect illumination of the streets in Paris made it necessary to place a lamp in front above the driver's head, and have at least three horses to move the vehicle.

It is conceded that the French were the first to run omnibuses for the conveyance of passengers, somewhere about the middle of the seventeenth century. In the original petition it is stated that "the undertakers were influenced by a desire of contributing to the convenience of a large class of persons who had not the means of conveyance in a hired chaise or coach, for which they would be charged a *pistole* (11 livr.), or at least two *ecus* (5 livr. 14 sous) per day." This petition was presented to the Privy Council on the 25th of November, 1661, and granted Jan. 19, 1662. An unlimited number of vehicles

were to be stationed at convenient spots, and to be started at certain fixed hours, whether empty or not, at the price of five sous each individual the entire route, and for lesser distances, or the faubourgs, in proportion. No soldiers, pages, lackeys, servants in livery, workmen, or laborers were permitted to ride in them. In the route thus established seven vehicles started, for the first time traversing the streets leading from Porte St. Antoine to the Luxembourg. Sauval says the vehicles for the first few days were followed by noisy hootings from the populace. After a few years these vehicles ceased running. Soon after the introduction of these omnibuses (in 1664) post-coaches are said to have been invented in France, but, as will be seen in our English history, they were used in that island long before.

The figure below represents a round-bodied coach of singular construction, which made its appearance at Frankfort-on-the-Main in 1667.

The standing pillars are said to have been fitted with sliding window-frames, glazed with Venetian ground glass. This carriage, after the manner of the age, was strengthened by two stout perches running beneath the body, which was suspended on leather straps stretched be-

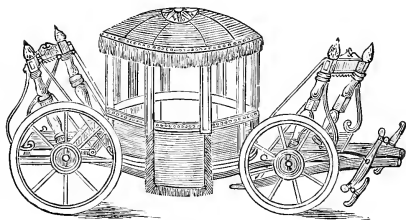

ANCIENT COACH, 1667.

tween two pairs of solid wooden standards, these last being well supported by heavy iron braces. The furchells¹ likewise appear unnecessarily heavy. Covering the doorway still appears the familiar "apron" bordered with fringes. We shall again meet with examples of similar construction in our English history of earlier date.

In the Musée de Cluny, Paris, we saw a coach of this period hung upon thorough-braces supported by four standards similar to the last. Two ponderous wooden reaches, one on each side, strengthen the running gear. In front these are mortised into a bolster, and behind into the axle-bed, having iron steps for getting into the carriage secured to each about the center. The rickety footman's stand in the rear hangs

¹ This word comes from the Latin *furcula*, a little fork, which instrument it somewhat resembles.

in a sling of leather straps. The wooden axles have large linchpins through the ends securing the wheels, which are necessarily out of proportion, the front being only two and a half, while the hind wheels are seven feet high. There is also a hammer-cloth seat for the driver, set off with gimp lace. The inside body linings are figured silk, likewise finished with gimp, the holders being of the same kind of material.

This Cluny collection embraces two more coaches of a later date, noticed elsewhere, besides four ancient two-wheeled vehicles, two sleighs, two sedans, one child's wagon, and several smaller models of old carriages in enclosed glass cases, besides twenty-four sets of double harness, eight sets quite plainly made, and sixteen with gilt mountings.

The first claiming our attention is a kind of buggy having wheels six feet in diameter, secured to the axle-tree by nuts, with a linchpin through the same. The body, singularly modeled, is elaborately painted. The shafts are crooked, similar to those seen among us a few years since. A step behind, hung in leather straps, supplies a stand for the footman, whose convenience is further increased by the addition of holder-straps secured to the back of the body. Altogether this vehicle is quite unique, and worthy the inspection of every lover of the antique.

Another curious vehicle after the gig pattern is profusely ornamented with carvings on the rockers, front-pillars, and arm-rails, very low at the toe-board, without a dasher. There is a supplementary rocker placed between the thorough-brace on which it lays and the body proper. The linings are silk, on which are elaborate figures in needle-work.

The third is a Veronese carriage of the sixteenth century, by Gio. Batta Maretto, having wheels, five feet six inches in height, placed far back of the body, volante fashion. The body, which appears to have been made from a solid piece of timber, has raised figures carved on the outside, and several painted ones on the inside. The seat, an elevated one, we can compare with nothing unless it be the pulpits of Cromwell's time. Even the cross-bars are plentifully supplied with carvings, and the toe-board terminates with a fine figure of Justice in front, to which are added horse-heads at the corners. On the inside there is a beautiful picture of Aurora in paint. The cushion is made of very plain leather. Another vehicle very similar to the foregoing

in model, but much plainer, with a twelve-spoked wheel and tug-irons near the ends of the shafts, lined with tapestry, completes the collection of two-wheeled carriages.

Besides these there are two very old sleighs, — one shaped like the dragon of fabulous history, with monstrous paws, carved from the solid log and richly gilded, built for Louis XIV. This singular curiosity is fixed upon two enormous runners, united at the front ends, and surmounted with a glass ornament placed at the top. In the sides there are two doors hinged to the front-quarters. Behind is a seat for a driver, with pockets for his feet underneath, after the Russian manner. The other sleigh is of more simple construction and seemingly of later date, said to have been once owned by the queen of Louis XIII.

The phaeton, an illustration of which is annexed, is supposed to be of French or Flemish manufacture, probably belonging to the early part of the eighteenth century. At the time of our visit to London in 1873, it stood on exhibition in the Museum at South Kensington,

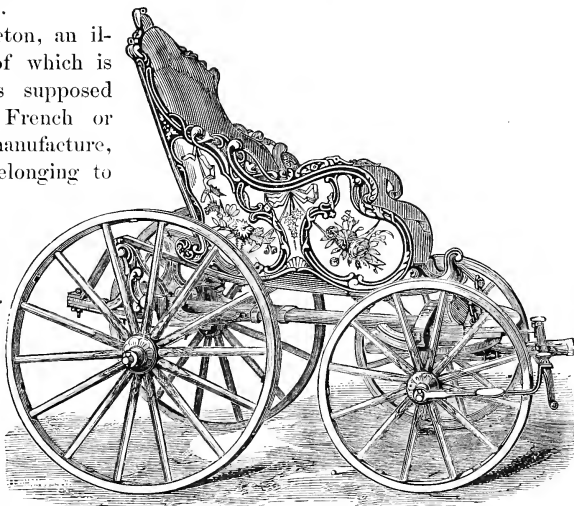

ANTIQUE PHAETON.¹

among a collection of antique carriages, to which it had been sent by a

¹ *Phaeton* comes from *φαίετον*, the Grecian name of a *fast* son of Phœbus, by Clymene. Contrary to the advice of Phœbus (the sun), Phaeton mounted his father's chariot and drove off, going so near the sun that the heat made him drop the reins, when, fearing lest his rash acts should set the world on fire, Jupiter struck him dead with a thunderbolt.

private contributor. The body is chair-shaped, that useful piece of household furniture having been frequently copied by the carriage-builders of former days. Its architecture is very much of the character shown in the vehicles of the Cluny collection, the side panels being ornamented by the painter with artistic skill. This is mounted upon thorough-braces supported at the ends by scroll-irons, proving indubitably that this carriage was built previous to the introduction of springs, which was some seventy-five years later. Like most of the ancient carriages preserved in the museums of Europe, this phaeton has solid proportions at variance with those of modern times.

In the "L'Art du Menuisier" we find a picture of the body of a *corbillard*, which Roubo, the author, says "is the oldest of French

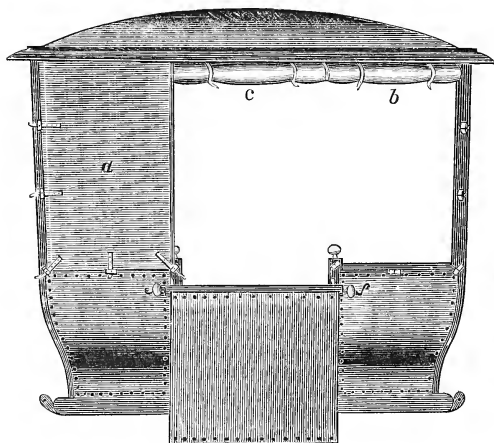

FRENCH CORBILLARD.

carriages the forms of which are exactly known. The carriages are open above the arm-rail on two sides only, which may be closed by leather curtains or other stuff, the old name for which was *mantelets*. These were attached to the pillars and the rails by several leather straps, as seen in the drawing. When fresh air is required

these curtains are rolled up close under the rain-molding of the top, which protrudes sufficiently to protect them. The two ends of the carriage are closed by leather curtains or other stuff.

"The outside of the body proper is covered up to the arm-rail with panels, and these are again covered over with leather or other material. These carriages have no doors, only two openings at the sides, which are closed by a piece of leather fastened to a wooden bar, *c, f*, held to the body by two iron hooks. This wooden bar also serves to

protect the persons sitting at the door against falling out, and is therefore rounded, and in some instances ornamented, on the top. The lower edge of this piece of leather is fastened to the step, extending below the edge of the body proper about twelve inches, constituting a kind of addition to the same sufficient to give leg-room to those sitting at the door. The step is likewise inclining about six inches, to facilitate ingress and at the same time extend the leg-room. The *coffre*, or extension of the body which forms the doors, is composed of an iron rod attached to the body, and is likewise covered with leather or other stuff.

"The seats are arranged the same as in our ordinary carriages, for two persons on the front and two more on the hind seat. The seats near the door are movable, and may be lifted up so as to make room for entrance to the carriage, and are held horizontal by bolts fastened to the pillars. These seats are each long enough for two persons, and an ordinary coach (corbillard) will consequently hold eight. City or private coaches carry only six persons, two at the doors and four inside.

"The principal dimensions of the carriage-body are as follows: length, six feet six inches; width, measured at the arm-rail, three feet nine inches; and from the bottom of the body to the upper side of the top [roof], five feet four inches. Height up to the arm-rail, two feet two inches; width of doors (or rather the opening for entrance when calculated for seating two persons), two feet nine inches; when for one person only, two feet three inches; and the door-holders (the iron bars), about six inches lower than the arm-rails.

"In general I represent here only a very simple coach, but it may be surmised from the illustration that in their day these coaches were susceptible of many decorations, such as costly stuffs, gold and embroidery, ornamental to both the in and outside of the curtains, door-pieces, etc.; but there being nothing positive on this subject, I give it as conjecture, only I think it the more probable, as our ancestors, perhaps with less taste than we have, were lovers of magnificence."¹

The old French author whom we have quoted says that "the number of modern carriages is quite considerable, according to their different forms, sizes, and uses. This is easily accounted for, as they are

¹ See Roubo's *L'Art du Menuisier*, pp. 462, 463.

works of taste and, if I may say so, of caprice, as patterns and dimensions may be changed indefinitely without altering the construction, which in all cases is about the same. For this reason I think we may classify our carriages in three distinct and different kinds. First, ancient carrosses, of which the exact form is unknown. These were subsequently changed into coaches covered with a stationary roof, the sides of which were only closed to the height of the arm-rail, the upper portion of which was provided with curtains of different material, sometimes leather, as may yet be seen on some public conveyances which have preserved the form and name of these ancient coaches, and in corbillards, a kind of vehicle intended for the exclusive use of great dignitaries. After these coaches another carriage was thought of, the sides of which were closed all the way up, with doors to open, and solid; these had the modern name of carrosses.¹ These carriages were very large and splendidly finished, but on account of their enormous weight they are now only used in kingly ceremonials or by dukes, or for the reception of ambassadors. The gearing of these carriages has no fork-shaped perch, but is in one single piece running under the middle of the body."

The coach of 1771 will be seen below. Coaches were then the chief vehicles employed in transporting the people from one province

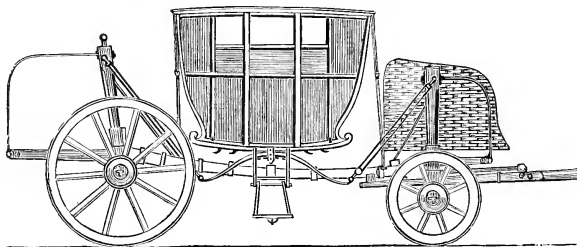

THE COACH (FR. CAROCH), 1771.

¹ A writer in the *Antiquarian Repertory* informs us that somewhere between 1643 and 1650 the word *carrosse*, previously used in the feminine, was changed to the masculine gender. This was caused by a mistake of Louis XIV, who on one occasion went out, and not finding his carriage in readiness, with great vehemence called aloud, "Ou est mon carrosse?" If the king had happened at any time to have said unguardedly, "*Ma pere et mon mere*," fathers and mothers, I make no doubt, would have changed sexes, such was the implicit adoration paid to the *Grand Monarque*. (*Antiquarian Repertory*, Vol. IV, p. 642.)

to another; and since they were expected to encounter rugged and uneven roads, they were built extremely solid and heavy, being nearly six feet wide on the seat, and eight feet high, with a simple flare of about one inch to the sides. The lower portions of the corner-posts were finished in half-fantail form, as shown in the engraving, the body being steadied by straps attached to the reach and roof.

"The second kind of modern carriages are called *berlines*, from Berlin, the capital of Prussia, where it was invented [somewhere about 1660].¹ The difference between these berlines

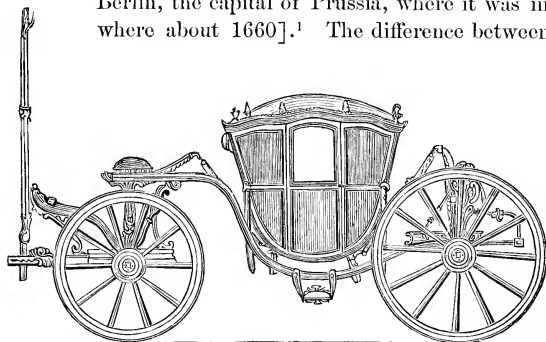

THE BERLINE.

and the carrosses is that they have two perches in the gearing above which the body hangs in such a way that the doors extend the entire height of the body and opening above the perches. Originally these berlines were different from the carrosses in another point, as they were, and still are, hung off on two horizontal leather braces attached to the two extremities of the gearing, instead of being suspended from the corners of the body; but since springs have been invented and in common use, the latter mode is deemed preferable, owing to the superior elasticity, making riding easier than long belts, which when wet lose their softness; but still many berlines are now hung on springs.

"Berlines being the kind of carriages mostly in use, it was undertaken to make them as complete as possible in the general formation and size, and this again gave them different names, such as berlines proper, berlines with two seats (carrying four persons inside), and *vis-à-vis*, when they had room for only two persons, one on the front and one on the hind seat, facing each other. To construct these ber-

¹ The inventor was Philip de Chiese, colonel and quartermaster in the service of Frederick William, Elector of Brandenburg, who died in 1673.

lines much lighter, the front door-pillar was cut at the height of the arm-rail, in such a way that the front pillar became a corner pillar.

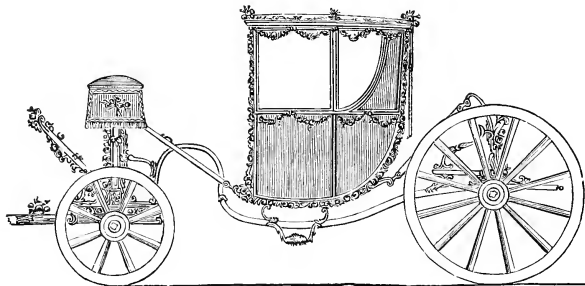

CHARIOT.

This class of berlines was called *carrosse, coupé, or berlingot*, or more commonly *diligence*, seating only two persons on the back seat, but in some instances three by the employment of a movable seat. *Diligences* containing only one person in a seat were in consequence called *desobligeants*." Laurence Sterne, in his "Sentimental Journey," notices these *desobligeants*, and tells us that when he

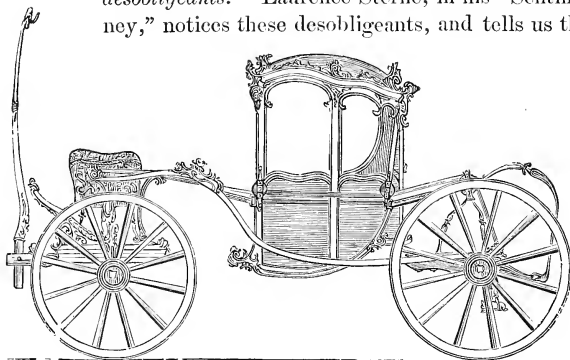

DILIGENCE.

was in Calais, and a lady wished to travel in the same vehicle as himself, he could not *oblige* her, as it would seat but one passenger; and so the

lady had to wait for another *disobliger* in order to pursue her journey.

The later diligence (see vignette at the beginning of this chapter), as the mail-coaches in France are called, is a very clumsily constructed vehicle, the body consisting of three in one, the diligence being drawn by five or six horses, a postilion sitting on the saddle

of one of them, the same belonging to the *poste royale*. The first body is called a *coupé*, and is shaped like a chariot, holding three passengers; the second, like a coach, holds six persons inside; the third, similar to a coach turned sideways, carries six or eight, and is termed the *rotonde*. In addition, on the roof, before the place appropriated to luggage, is the *banquette*, a bench covered with a hood, holding four outsiders. When all is filled, the *conducteur*, or guard, takes his seat among the luggage to protect it from robbers. The coaches move four or five miles an hour, fares being charged in the order of places above named.

"The third kind of modern carriages," continues Roubo, "are the chaises of all kinds, which as a general thing have only two wheels. Chaises accommodate either one or two persons, and are different from carrosses, coupés, or diligences, as the body sinks below the supports of the gearing, having no doors in the sides, which if they did could not be opened,

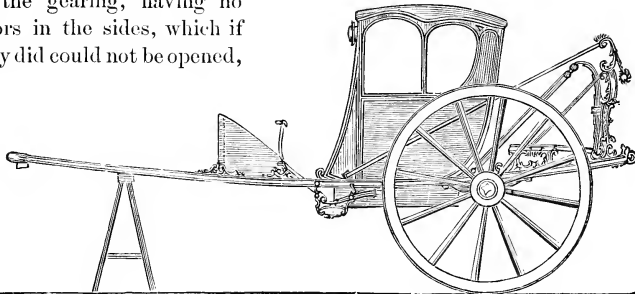

CHAISE.

because the shafts would be in the way; but there is a door in front, the mountings of which are put on horizontal, so that in opening the door drops down. These chaises are a new invention, the older kind, called post-chaises, which we see in use to-day, having been constructed ever since 1664. The post-chaises in use before that time were merely a kind of easy-chair suspended between two poles and carried on two wheels. Post-chaises were not only, as their name indicates, used for postal service, but also, with a few alterations, by wealthy people in town. These had a door in the front and seated only one person, and were similar to the old litters.¹

¹ The author of *L'Art du Menuisier* says that "*lectica*, or litter, comes from *lit*, a bed, because persons riding in them rather reclined than sat; still, this origin of the

“Finally, there is another kind of chaise, sometimes called *rouettes* or *vinçigrettes*, but more commonly *brouettes*. Their form is nearly

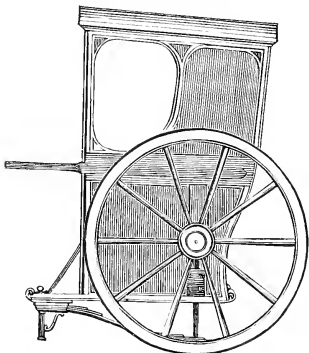

BROUETTE.

that of the *chaises-à-porteurs*, except that they have two wheels, and are supported by springs, the mechanism of which is very ingenious. These chaises are drawn by men.¹ These in general are the three distinct kinds of modern carriages, not counting a variety of others which are only variations of these chief kinds, such as *berlines* with four doors, *gondolas*, *dormeuses*, *caleches* with several rows of seats and a top supported by iron pillars, with the sides either open above the arm-rails, or closed with curtains. The *diabes* [devils], a

kind of diligence in which the upper portion of the door is cut off; the phaetons, a kind of open caleche or *char*; the chaises, with falling tops (*en soufflets*), which originated in Italy; the cabriolets, a kind

word is only conjecture. . . . If the authors who wrote on this subject had said a few words more, we should not remain under the uncertainty in which we now are. This is proof that in matters of art, as in all other things treating on the costumes and progression of nations, nothing is superfluous considering the great difference between ancient and modern usages. Consequently the necessity is proved that every author ought to be as circumstantial as possible when writing for posterity, the customs of which must differ from ours, so that they may not be in like situation with us, denied correct and full records. We need not go back a century, nor beyond the limits of our own country, to show how necessary it is for the glory of our age and the future to treat the history of art with amplitude and correctness, not fearing to say too much, even at the risk of being looked upon as too prolix, public utility being preferable to the reputation of an elegant writer.”—*Note to L'Art du Menuisier*, p. 490.

¹ Adams, in his *History of English Pleasure-carriages*, says that “the first attempt at a common usage of covered wheel-carriages amongst the Parisian citizens occurred at this time (1620), in the introduction of a vehicle called *brouette* or *rouette*.” He has not informed us where he obtained this extraordinary piece of information, but it is safe to infer that he is mistaken, after reading what Roubo says of them in his volume, and our account in this chapter. Bronettes were in use for over forty years. Riffe, of Paris, obtained a patent for a simple sharp-pointed iron leg attached to the hind end of the bottom sill, which, resting on the ground, prevented its tipping over backward when at rest. The patent is dated Jan. 24, 1806. (See *Brevets d'Inventions*, Vol. VIII, Pl. XXVIII.)

of chaise or small *char*, sometimes open, sometimes closed; the wagon for gardens, two and four seated; and the sleighs, serving to ride on over ice or frozen snow. All these different carriages are again differently named according to their uses in town or country; yet there is not much difference between them, at least in those of one and the same kind, all the difference in them being in the solidity and strength or the fineness and coarseness of the finish."¹

Some of these carriages were furnished with glass in the doors and side-quarters, but the coach we have presented on page 226, designed especially for travel, was paneled up very high, probably the more effectually to secure the passengers against the attacks of robbers. But when coaches came to be more generally used in towns, the panel was lowered that the dames of France when riding might show themselves to better advantage. A modern writer tells us, "It is pretty certain, by reference to many authorities, that it was not the *women* who introduced the wooden box on wheels which coaches became previous to the application of glass, for, rather than not be seen, they would have ridden with even no roof to the *char*, and in the rain; but the fact is, that so great a scandal in the early times of coach-building was attached to the use of coaches, that the *husbands* were glad to box up their wives who insisted upon keeping their carriages, and who thereby laid themselves open to the attention of every young courtier who did not know what to do with his time. It was impossible for the husbands to object to the use of glass in coaches, and so, very rapidly, after the first pane of glass was seen in a French carriage, glass doors [doors with glass] became the fashion in the streets of Paris." The first coach to which glass was applied is said to have been the state-carriage of Louis XIII in 1620.

Carriages in France at the close of the eighteenth century were very costly, the same being covered with carvings, moldings, and gildings, so that with these and the upholstery the vehicle was made many times more expensive than it would have been built plainly. We will not, however, go so far in our censure as an Englishman has done, and complain that "the gilding and carving even broke out on the wheels, not a single spoke being allowed to exhibit a straight line, the

¹ Translated expressly for this work from Roubo's *L'Art du Menuisier*, pp. 458-461.

center of the wheel being embossed till it looked a huge mass of ornamentation, and even the rim engraved and molded even far below what I may call the mud-line"; for nothing in our researches confirms such assertions, the carvings, as we have seen, being confined to the bodies, perches, and standards, except in the royal carriages. Some of these are preserved in pictorial representation in the galleries of the Louvre, but they exhibit the exception rather than the rule. One specimen of "high art" is said to be still in preservation at Toulouse, the interior of which is lined with white brocade embroidered with a diaper of pink roses, the roof being lined with the same, the angles being hidden by smiling Cupids in gilt. The surfaces of the panels are pure opaque white, bordered with a wide molding of pink roses, and the foliage, instead of being green, is gilded, and the whole afterwards varnished.

From the middle of the seventeenth to that of the eighteenth century, carriages generally seem to have been made exceedingly heavy, the body, as a rule, being seven feet long at the bottom, and eight measured on the roof, the flare on the sides ranging from two to three inches. The width of the body was about four feet six inches measured across the middle at the doors, and four feet measured at each end. The front and back panels in some instances were formed after what has since been called the tub shape, and at other times in the half-fantail order. Sometimes this last is denominated the S form. The side panels of many ancient carriages in France were set off with sweeping moldings or *consoles*, for the purpose of hiding joints and improving the finish. The ancient French carriage-

maker seems to have studiously avoided the appearance of a step on the side of a coach, and therefore, as we see in the illustration, he framed his bodies with a *sinking bottom* in which to conceal the step when not in use. This, although intended as an improvement over the bodies on page 219, in which a leather apron supplies the place of a door, is far from being comely in the eyes of the modern builder. In the eye of a Frenchman, however, the

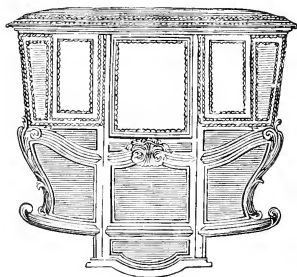

ANCIENT CARROSSE-BODY.

step-box was less objectionable than the sight of a ladder, and consequently lightness was sacrificed to prevailing taste.

During the first quarter of the present century, very little in the line of invention appears to have been accomplished, unless it was — under the name of improvements — to make existing vehicles more complicated and painfully impracticable. Especially open to these charges are the patents applicable to traveling carriages, which were then in more demand, caused by improvement in the roads throughout the empire. It must not, however, be surmised that ingenuity had altogether run wild by any means, for, indeed, something really ingenious was discovered, as will appear as we proceed with our history.

In the Musée de Cluny, Paris, is a fine specimen of the *coachee*, built near the close of the last century, with C-springs, over which are stretched long thorough-braces covered with fancy stitchings in black. Two crane-necked iron reaches, with the front ends inserted in a bolster, and the back ends running through the axle, strengthen the carriage-part. The wheels are three feet six inches and seven feet high. The panels are handsomely painted and ornamented with figures. Inside curtains and footman's holders are supplied to the body.

In the same collection is an elegantly finished coach, with springs, such as shown in the chaise on page 229. There are iron reaches underneath the body, the front ends of which are inserted in the standards or brackets supporting the foot-board. The body rests on thorough-braces enclosed in goat-skin profusely ornamented with silk needle-work. On the doors, the handles of which are in the middle, in monogram, are the initials "T. M. S." The hind wheels stand over seven feet, while the front are only four feet high.

The last we have to notice in the foregoing collection is a berliner, with glass windows letting down. The body-loops run the whole length, and the braces of harness leather which loop them to the French-horn springs are, like the last, encased in goat-skin. A single wooden standard framed into the bolster, having an iron brace at the top, supports the dickey-seat, which is furnished with a hammer-cloth, the groundwork of which is silk, set off with gimp lace. The toe-board is profusely carved, and a step and holders are added for the footman. The wheels, which have ten spokes in the front and

twelve in the back, are respectively three feet and six and a half feet high. The hubs, spokes, and wheels are capped in a manner we have never seen elsewhere.

A singular mode of hanging off carriage-bodies was invented and patented by one Simon, native of the city of Bruxelles, dated June 26, 1810. A back view showing the invention is annexed. The springs of the C form, as usual, are fixed at the top, following the direction of the axle. This disposition of the springs, it is claimed, not only allows of a narrower carriage-part, making it more compact and stronger, but permits the hanging up of a wider body than could otherwise be done with a narrow-tracking under-carriage. The invention possesses no real merit, and is here given merely as a curiosity.¹

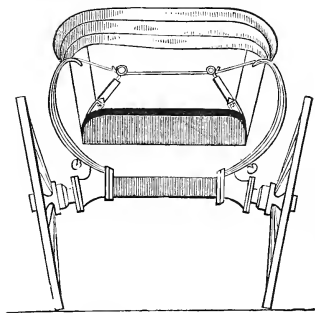

SIMON'S PATENT.

A very singular contrivance of Col. Joseph François Louis Grobert was patented May 19, 1818, having for its object the improvement of cabriolets. Two advantages are claimed for the invention: first, to impart elasticity to the movement of the vehicle when loaded with passengers, and to relieve the draft of the horses; secondly, to lower the center of gravity, influence the moving power, and lessen the danger of upsetting. This patent was intended for both business and pleasure vehicles.² In the drawing of the horse (on opposite page) we see a cropped tail, called in Europe a "bang-up blood-tail," which, although passable in a light animal, looks ridiculous in a heavy one. We are sorry to find this absurd custom gaining popularity in America. It is, however, some degree of satisfaction to find that thus far this ridiculous practice in short-docking has been monopolized by men who made their entrance into this world in a foreign land. In our judgment, these gentry should be taken in hand by the Society for the Prevention of Cruelty to Animals, for mutilating the noble horse.

¹ See *Description des Brevets d'Invention*, Vol. VI, Pl. II.

² *Ibid.*, Vol. XV, Pl. XXIX, Fig. 1.

Extension tops, very common in the United States, were early in use in France. Messrs. Leclerq & Crombette, carriage-makers, of Paris, obtained a patent for one dated Dec. 28, 1822; afterwards,

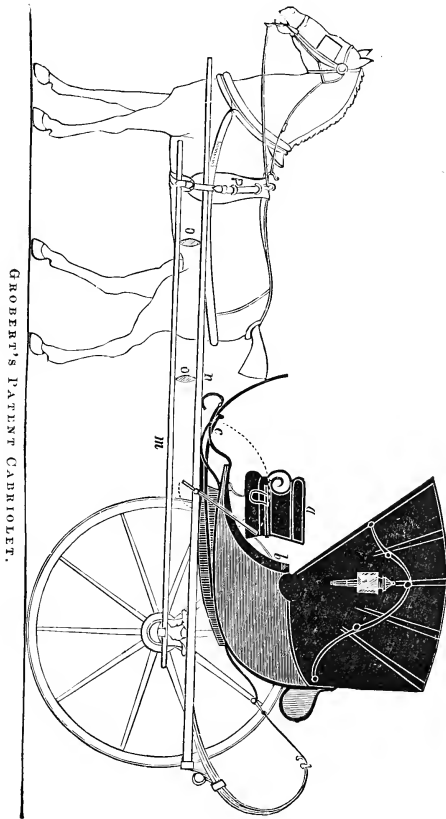

with further improvements, Nov. 27, 1823.¹ A copy of the original drawing is shown on page 236. The body supporting the top was

¹ See *Description des Brevets d'Invention*, Vol. XV, Pl. XXVII.

imitated in this country a few years later, the turned sticks in the seat of which are similar to those found in American carriages of the same date, but have for many years been out of fashion.

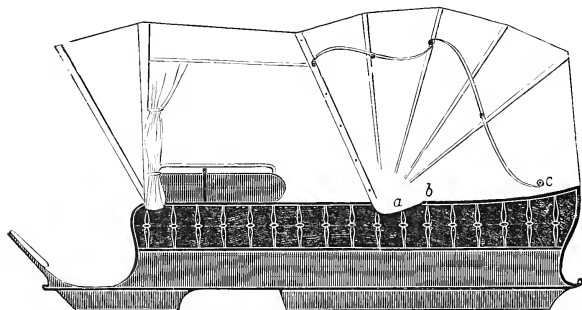

EXTENSION HEAD FOR CARRIAGE.

Another rather singular two-wheeled vehicle, modeled after the coupé, called a *triolet*, was invented by M. Avril, of Paris, Dec. 6, 1826. This was suspended on a single half-elliptic spring, the center of which, resting on, was secured to, the axle, with the raised ends protruding at the sides. To these ends were attached two upright standards, reaching higher than the roof, at *d*, connected by the

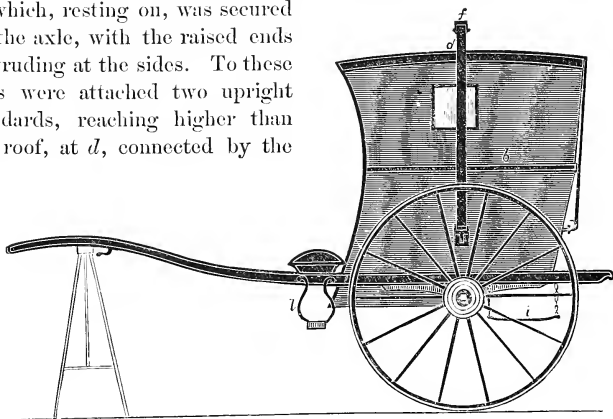

AVRIL'S TRIOLET.

cross-bar *f*, extending across the roof. This vehicle carried three persons, exclusive of the driver, who sat upon the front seat over

the step. At *i* is shown a drop supported by four chains, the object of which is unknown.¹

Two years later (April 30, 1828) M. Jean Louis Tellier, of Amiens, Department of Somme, contrived a machine to prevent upsetting. This is done by rods, *a, a*, hinged on either side of the body near the top, with rowels inserted in the lower ends. Should the vehicle with these safeguards tilt either to the right or left, the rod on the falling side adjusts itself for the emergency, and thereby prevents serious consequences to the passengers or carriage.²

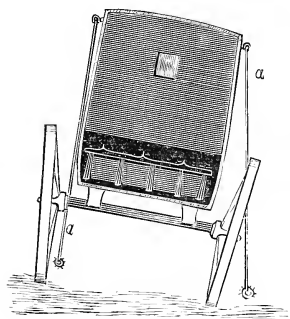

TELLIER'S PATENT SAFETY CARRIAGE.

one Charles Hamond, a civil engineer, secured a patent on what he

called a *monocycle*, or a vehicle with only one wheel; which, being decidedly *sui generis*, we have had transferred to our pages. Fig. 1 represents a side elevation of

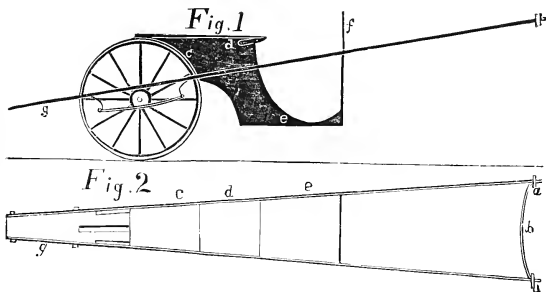

MONOCYCLE.

the vehicle; Fig. 2, a bird's-eye view of the shafts, the front end being at *a*. The inventor claims that in time "these carriages will be preferred to all others in transporting the wounded, the sick, and women *enciente*." Alongside of this the velocipede is nowhere!

Carriages were quite common on the Continent when they were first

¹ See *Description des Brevets d'Invention*, Vol. XXII, Pl. XXII, Fig. 1.

² *Ibid.*, Vol. XXVI, Pl. XIV.

introduced into England in the days of Queen Elizabeth, as these pages amply prove. In design, likewise, at a still later period the French were far ahead of other nations, but whether this superiority is maintained in our times is a matter of some doubt. The English dispute it; and a writer of that nation relates a story which, if true, would seem to confirm the idea that English vehicles were superior to the French. Condensed, it runs thus: An enterprising Frenchman, by the name of Mitty, having business connections with the English nobility, through whom he heard of the good qualities of English-made vehicles, and the higher prices they sold for compared with the French, felt disposed to speculate by importing them from abroad, the duty only standing in the way of his plan. This, however, after study, he thought might be avoided; and accordingly he made an attempt, by purchasing a barouche and two landaus in London, second-hand, which he shipped to Belgium on an Ostend packet, which, after several mishaps, were landed at the destined port, and sent off in charge of friends by different routes for the French capital, in order to avoid suspicion. Quiviac was the nearest French border, for which place, after hiring a horse, Mitty himself set out, changing the animal *à la poste* on the road, by which means — since he was a good linguist, and understood the country well — he accomplished his object with perfect safety. Not so his friends; for one, through ignorance of French, unfortunately took the road to Mechlin, and on finding out the mistake was compelled to retrace his steps; the other, with a landau, overtaking a lady on the road, became so fascinated with her charms that he invited her to a ride, which she accepted. The couple got along charmingly until the lady's husband, a burly Flemish farmer, overtook them, claiming his wife in language not to be misunderstood. A satisfactory explanation being given, the smuggler was permitted to drive on, losing his passport during the encounter. These misadventures occasioned some delay, but eventually they all reached Paris. Mitty, having soon adjusted his English carriages to French exigencies, sold them at an advance upon the cost; but the trouble he underwent in the speculation so worked upon his mind that he vowed that, whatever might be his next adventure, English carriages should not be his choice!

There is a kind of vehicle used in France and neighboring states, called *char-à-banc*, copied after the national carriage of Switzerland, where it is used as a kind of gig, placed sideways upon four wheels,

at a little distance from the ground, and is furnished with leather curtains made to draw. This is the smaller kind. There is a larger kind in which there are two or more benches suspended by thongs arranged

one behind another. These Swiss vehicles have been adopted in France, where they have assumed various forms, one of which is seen in the engraving. This is a family-carriage for traveling about the country, and is a great favorite with the aristocratic population, being not

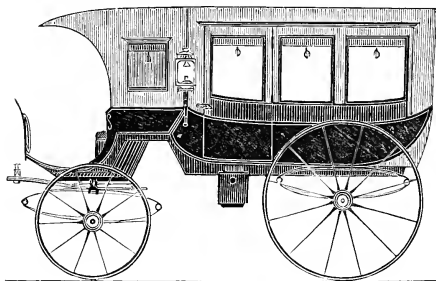
CHAR-À-BANC.¹

only roomy, but effectually sheltered from the weather by sliding windows, on the plan of an omnibus, which in some respects it resembles. The fore part, under which the wheels turn, assumes the cab shape, in which is seated the driver and other servants. The inside passengers, four or six in number, enter by a side door, seen in the engraving, instead of back, as is usual in the omnibus.

Certain vehicles are known as *vis-à-vis*, which, literally interpreted, means a carriage in which the passengers are seated face to face with each other for conversation. There is a variety of vehicles known as *vis-à-vis* among Frenchmen, receiving different names elsewhere; but our engraving fairly represents the carriage generally admitted as such by those in the carriage-trade. More

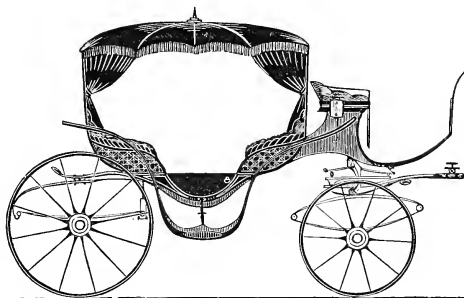

VIS-À-VIS.

¹ This term "char-à-banc" is derived from *char*, a chariot, and *banc*, a bench, meaning a carriage of benches, otherwise a row of benches.

frequently these carriages are used without tops, built extremely light for European mechanism, suited to the fine roads that everywhere abound in France, saving the horses much unnecessary toil and suffering, besides avoiding strain and injury to the carriage and wheels. This vehicle is mounted on elliptical springs in front and platform springs behind, without a perch, and is supplied with a removable sun-top, very comfortable and convenient in summer weather.

The French have a class of vehicles they call *tapissière*. In their vernacular it means tapestry (hanging curtains), and receives its name because it is what others call a curtain

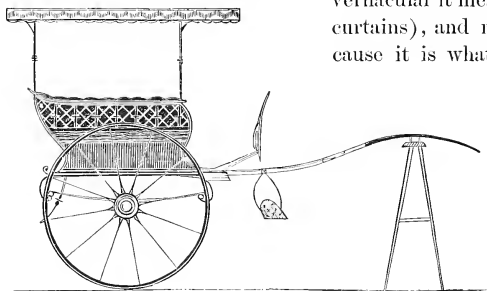

TAPISSIÈRE.

vehicle. A Frenchman long ago charged that in London "there was a wonderful dignity belonging [applied] to carts," but here in France we find them dignified with

tapestry, and more highly finished than anywhere else, although French authors complain that "the greater number of two-wheeled carts which roll along the streets of Paris are badly made and mounted."

We have never yet satisfactorily discovered whether the *dog-cart* be an English or French invention, as it is common with both nations, where it is used for hunting as well as pleasure-riding. As, however, neither Felton, Adams, nor other English writers lay claim to dog-carts as being English vehicles, we take it for granted that they are of French origin, inventions of the present century, since Roubo, who wrote about one hundred years ago, taking especial pains to enumerate all carriages then in use, says nothing about them in his French list. The dog-cart, on next page, dates from about 1845, and is driven tandem.¹ Here the aristocratic driver and his complaisant groom sit back to back, bolt upright, the servant with his feet resting on the tail-board, suspended by chains. Among the ancients, dogs attendant

¹ Horses are harnessed tandem when driven one before the other. In horsemen's Latin it refers to length of line.

on the hunters were required to use their legs, but in later times, the species having, as well as their masters, become more aristocratic, are

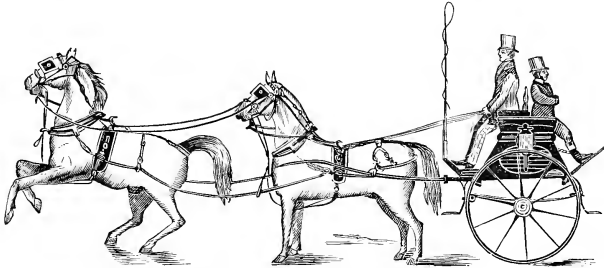

FRENCH DOG-CART.

now allowed to ride with their *companions* in the box, hence the name dog-cart. By means of an ingenious contrivance applied to modern dog-carts, the body is made to slide, adjusting the burden to the comfort of the horse. Notwithstanding the undignified character of the name under which this class of vehicles pass, yet they find favor with a select few of the aristocracy, for the simple reason — nobody else will ride in them.

The French have in their carriage list a vehicle known as the *boguet*.¹ The annexed engraving is a fair representation of this class of light two-wheeled vehicles.

This carriage is hung up on two cradle, two toe (grasshopper), and one half-elliptic cross-spring behind, supplemented by scroll-irons underneath the body. As thus mounted, it furnishes an easy-riding

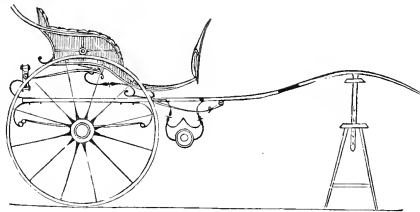

BOGUET.

carriage for the passenger, but is unpleasantly fitted to the horse, as all two-wheeled vehicles unquestionably are.

There is no mistaking the *nativity* of our next carriage. It is called everywhere a *coupé*, from the peculiar manner in which the front part,

¹ Is not our English word "buggy" derived from the French word *boguet*? And are not the English Tilburys and Stanhopes simple transformations of the boguets?

supporting the driver's seat, is attached to the main portion of the body. The forward department of a French diligence is known as the coupé, and from this the word is supposed to have been borrowed for

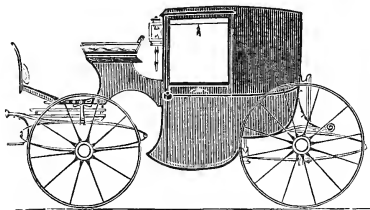

COUPÉ.

the carriage since called by that name. At one time these vehicles were decidedly popular in Paris and elsewhere in Europe, but since the introduction of pony and other phaetons of a much lighter character, improvements have been neglected on the coupé, and the vehicle itself is now in

comparative disuse, except among the English-speaking people here and in London, where coupés are much more handsomely gotten up. Our design — of French origin — represents the vehicle for two inside passengers, but, when furnished with a circular front, a turn-down seat may be added for a child's convenience. For the use of ladies making calls or engaged in shopping, no better carriage has yet been invented.

Another carriage that to the uninitiated observer looks very much like the coupé is called a *demi-caleche*, the top being contrived so as to fall back after removing the door above the belt-rail, making it an open carriage that will in time in a great measure supplant the coupé in park airings.¹ There is still another pleasure-carriage, called by the French a *landaulet chaise*, being below the belt-rail similar to the coupé, and having above it a head (top) like the *demi-caleche*, to throw open in fair weather. We

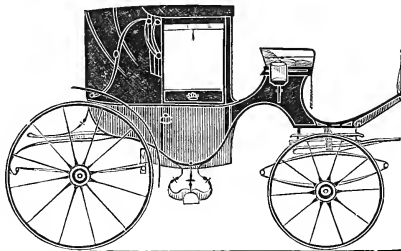

DEMI-CALECHE.

would remark, *en passant*, that some of the larger kinds of French vehicles of the coupé variety, such as the *coupé de ville* and *coupé*

¹ This prophecy, made in 1873, has since been verified.

d'Orsay, bear so strong a resemblance to the English clarence as to almost deprive the duke of his claims to the honor of an inventor. Of this, however, our readers will judge, after comparison.

We now for a moment turn from the private to the consideration of public carriages in Paris, where they are generally called *fiacres*, as previously noticed. In 1858 these numbered nearly four thousand, all managed by a consolidated company, guaranteed a monopoly of trade, but limited in their charges by the city council to the following rates: to any distance within the fortifications, from six in the morning to half past twelve at night, for a two-seat carriage fifteen minutes, fifteen sous; for four-seat, the same period, eighteen sous; and for five-seat, the same time, twenty sous, with proportional rates for longer time. The charges were twenty-five per cent higher the remainder of the day, unless the carriage had been ordered before midnight, and more time was needed in which to complete a job. When a carriage had been engaged before six in the morning, but arrived after that hour, the customer paid only the night tariff. Parcels that could be carried in the hand went free, but boxes and trunks, not exceeding two, paid four sous, and any number above that could only be charged ten cents, the coachman being required to load and unload free. It was made obligatory on the coachman to furnish each passenger with a card containing the tariff of prices and number of the carriage. The coachmen were obliged to follow such routes as the passenger indicated, and drive at the rate of ten kilometers, but in doing so, should the carriage be hindered by obstructions, the traveler was charged for any loss of time. When going to crowded places, such as balls, theaters, etc., fare could be demanded before arrival. To prevent cheating on the part of employés, the company had every vehicle numbered, stationing a clerk at certain points to note the time each carriage either departed or arrived, all being compelled to stop and report at the nearest station, these being close together, no empty carriage being allowed to pass a station under any circumstances. Only in cases where special contracts were made could the foregoing laws be nullified.

A literary coach maker thus complains of his fellow-tradesmen in 1859: "Some Parisians set themselves up as first-class dealers, a few perhaps worthy men, who manage by degrees to ruin trade in fine carriages by going to a manufacturer — sometimes the manufacturer goes to them — and agreeing upon a price which is much under the costs,

bringing ruin upon him, — a proceeding not more creditable to him who ruins another, than to him who ruins himself, the only difference being the one maintains his solvency and the other fails.

“On the other hand, the second-class dealers are more ruinous than the sharpers among the former, for they never were, though they go so far as to call themselves coach-makers, although they keep in their show-rooms as many as fifty carriages, new and second-hand, calling everything with wheels and springs a *carriage*, the qualities of their wares, added to their ignorance of the business, proving very injurious to trade. These procure their stock at the cost of old iron (in fact, they are but old-iron mongers), which is unworthy the name of carriages, the seller ruining those who buy them.”

A favorite drive in Paris is Longchamps. A visitor thus describes a scene thereon on a fine day in 1860: “Crowded in this thoroughfare were carriages, some with four and some with six horses, gliding by, hung up, some on platform and some on eight springs. The most fashionable equipages were distinguished by very high and long bodies, really possessing a noble and dignified appearance, the long look destroying the *tout ensemble*”; but to crown all, our writer, who was himself a Frenchman, saw “phaetons (driven by persons who had the appearance of perfect gentlemen) that had the fore wheels of a large size, as high as the hind ones, giving the vehicle the appearance of a charlatan equipage!”¹

The next carriage is called a *braeck*, but whether of French or English invention is unknown; we incline to think it French, however. These are generally driven with four horses when they are employed in park airings, and with two only when used in the chase. The engraving is from a design by M. Brice

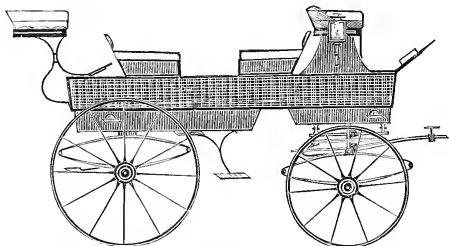

BRAECK.

¹ This writer evidently was not in sympathy with the ideas of our author who wrote on *English Pleasure-carriages*.

Thomas, of Paris, giving the reader a correct idea of French taste applied to such vehicles. These carriages will accommodate from six to eight persons, including the driver and servants.

In France, as in England and America, very light phaetons are much used in pleasant weather, particularly by the ladies, for whom they seem to have been specially designed. These phaetons, we

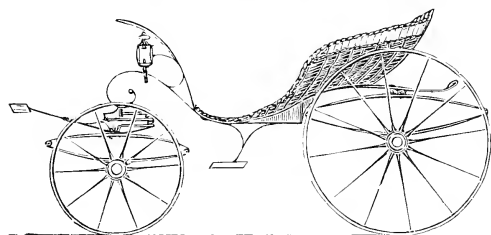

WICKER PHAETON.

learn from Felton, were used in London nearly a century ago, and there is good reason to believe they were invented much earlier. The lightest of these vehicles have bod-

ies made in frame, interlaced with basket-willow, as shown in our engraving; others are mere imitations in wood. These generally carry two persons, but sometimes a child is added. The French have displayed great ingenuity in the application of names to this class of carriages. With a servant's seat attached to the rear, it becomes *panier duc*;

with a dickey-seat in front, it becomes a *mylord*. Were it not the fact that many mylords were used in the humiliating business of hacking, we should be inclined to look upon them as belonging to the aristocratic class of phaetons. Cabriolet mylords are quite numerous, so are *Eugenia cabs*

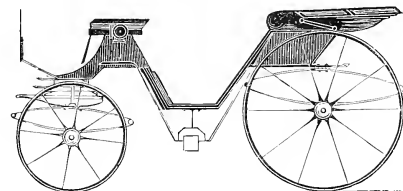

MYLORD.

and *vis-à-vis*, many of which would be claimed by Englishmen as nothing more than *Victorias* or *Prince Alberts*, which they indeed strikingly resemble. Vehicles of light construction are in Europe limited to a small number, and this fact has no doubt had much influence upon the phaeton nomenclature.

Carriages are so plenty in Paris, where they are driven at a high rate of speed, that as many as seven hundred persons are killed and

five thousand more wounded annually, being more than are killed on all the railways in Europe during the same period, — a greater destruction of life from like causes than occurs anywhere else on this planet.

A part of our plan, although at the risk of being thought too prolix, is to present to the minds of our readers the various shadings the French, English, and Americans give to similar carriages, in order that by contrast they may judge for themselves of the progress and

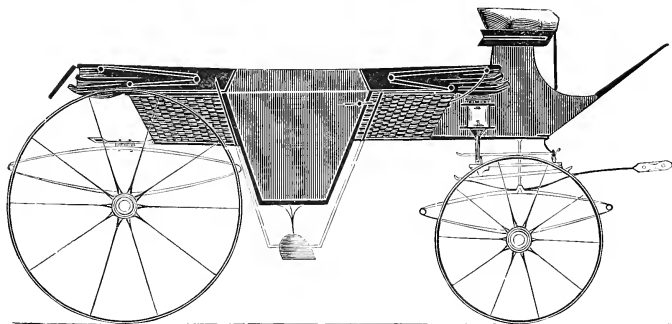

SINGLE-HORSE LANDAU.¹

condition of trade in the countries named. In furtherance of this object we give above one of the latest designs for a landau published in France. This vehicle is made light enough for one horse, — a feat seldom undertaken elsewhere in countries where the horses are inferior and the roads less improved. An ingenious elongation of the door-pillars supplies sufficient room for the feet of the rider, while at the same time the front and back quarters look very light, especially when these are in imitation of basket-work, as in the engraving. To allow the front portion of the head to fall properly, the dickey-seat is hinged and thrown forward, as occasion may require.

The next drawing represents a *caleche*² on elliptic and platform springs, without a perch. This construction of carriages, minus a

¹ This carriage, although very popular, is not claimed as a French invention. It is said to have been invented at Landau, a town in Western Germany, about 1758, hence the name. The invention is consequently more than a century old.

² *Caleche* (in English *calash*) indicates a carriage with a falling top.

perch, is one of the greatest improvements of modern times, since a

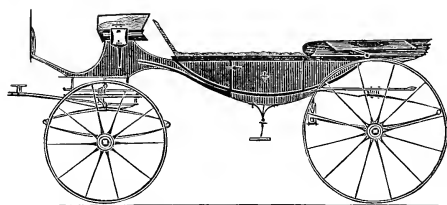

FRENCH CALECHE.

carriage thus made looks very much lighter, is more conveniently turned about, and not nearly so liable to rattle when in use as when built on the old plan. These vehicles are generally used

with two horses, the poles connecting with a sort of yoke called by

the French a *pompé*, fancifully made of iron, as shown in the engraving.

By means of a strap this is fastened to the collar of the harness, another strap being looped into this and kept in its proper place by a spring fixed underneath the pole.

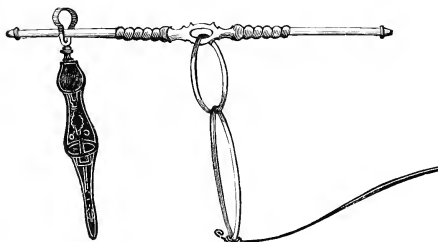

POMPÉ.

What has become of the old coaches? has often been asked. The following facts indicate where some at least have gone, being utilized for building purposes. Recently, while demolishing an old house at Montmartre for the erection of a church on the site, it was found the wainscoting of one of the rooms was composed of wood elegantly carved and gilded. The various pieces when put together show that it was an old royal coach, the panels of which had been used "to stop a hole to keep the wind away." The panels are supposed to be at least three hundred years old, probably belonging to the fifteenth century.

CHAPTER IX.

ENGLISH VEHICULAR ART AND ITS HISTORICAL ASSOCIATIONS.

“Carroaches, Coaches, Iades, and Flanders Mares
 Doe rob vs of our shares, our wares, our Fares :
 Against the ground we stand and knocke our heeles,
 Whilst all our profit runs away on wheelcs ;
 And whosoeur but obserues and notes
 The great increase of Coaches and of Boates,
 Shall finde their number more then e'r they were
 By halfe and more within these thirty yeeres.
 Then Water-men at Sea had seruice still,
 And those that staid at home had worke at will :
 Then vpstart Helcart-Coaches were to seeke,
 A man could scarce see twenty in a weeke,
 But now I thinke a man may daily see
 More then the Whirries on the *Thames* can be.”¹

JOHN TAYLOR'S *Thief*.

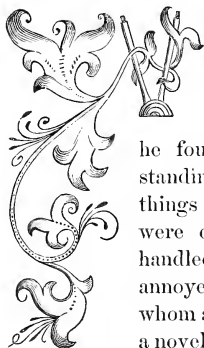

VERY little is known concerning British vehicles previous to the invasion of that country by the Romans under the leadership of Caius Julius Cæsar. When he reached the shores of Britain he found an immense army of the rude inhabitants standing ready to oppose his landing, and among other things it is stated that a great number of war-chariots were observed, which were so adroitly and skillfully handled by the ferocious natives that they very much annoyed his army of expert and well-exercised soldiers, to whom as instruments of warfare they appear to have been a novelty. Some idea of their numerical importance may be inferred from the fact that Cassivellannus, the chief of the confed-

¹ From a small volume entitled “*An Arrant Thiefe, Whom every Man may Trust: In Word and Deede, Exceeding true and Iust. With a Comparison betweene a Thief and a Booke, Written by John Taylor.*” London: Printed by *Edw: Alde*, for Henry Gosson, and are to bee sold in Panier-Alley, 1622.” In an edition of “*All the Workes of Iohn Taylor.* . . . At London, Printed by J. B. for James Bolter; at the signe of the

erated British forces, had stationed as many as four thousand of these war-chariots¹ along the coast as a corps of observation to watch the movements of the invader. In his account of a second invasion, Cæsar again mentions the cavalry and chariots, and tells us that the British chieftain, being unable to keep the field, disbanded his forces, retaining *only* four thousand chariots.

A few years afterward, when the Romans had shamefully abused the power they had obtained by conquest, and given themselves up to every species of insult against the natives, Boadicea,² the brave and spirited queen of the Iceni, having collected an army, undertook to drive the Romans out of the country. In this undertaking a great many chariots were employed, and no doubt with much effect. So numerous were the chariots in the army of Calgagus (A. D. 84), that the charioteers and horses crowded the middle of the battle-field.³

Marigold in Paul's Churchyard, 1630," the author dedicates the section in which the *Thiefe* is reprinted, "To any Reader Hee or Shee, It makes no matter what they bee." This eccentric individual, who styled himself "the King's Water-Poet," late in life kept the Poet's-Head Inn, located in Phoenix Alley, "near the middle of Long Aker," since having become famous as the business street for coach-makers, some of whom in former days may have been his best customers. Born at Gloucester in 1580, he died in London, 1653, and was buried Dec. 5, in the churchyard of St. Martin's-in-the-Fields, near by.

¹ Cæsar has left us a vivid picture of the strenuous opposition he met with from the barbarians on landing in Britain — supposed to have been in the vicinity of Dover — on the 27th of August, fifty-five years previous to the advent of Christ. (Consult Cæsar's *De Bello Gallico*, B. IV, 20.) For a detailed examination of this subject, the curious reader is referred to a paper in Vol. XXI, pp. 501-505, of the *Archæologia*, and still another in Vol. III, pp. 315-320, of the *Antiquary*.

² The name of this queen is given by various authors as *Boadicea*, *Bonduca*, and *Bonduica*. She was the widow of Præsutagus, under whose resentment eighty thousand Roman soldiers perished. Gildas calls her "a deceitful lioness," and her soldiers "crafty foxes." Giles, the translator of Gildas, assures us that "bold lions" is a much more appropriate appellation, and that her army would have been successful had it had but half the military advantages of the Romans. (Note to Bohn's edition of *Gildas*, p. 301.) When Suetonius commanded the Roman army (A. D. 59), this queen, on the eve of battle, seated in a chariot with her two daughters, incited her soldiers to courage by an harangue; and when the fortune of war appeared to go against her, she with her chariots prevented the escape of her people. (Tacit., *Ann.*, XIV, 34-37.) The remains of an entrenchment may still be seen at Ambresbury Banks, into which she retired after an unsuccessful battle, and committed suicide rather than survive indignity and defeat. A plain brick column on the estate of Sir F. Foxwell Buxton marks the spot where she died.

³ Tacit. in *Agricola*, ch. 35.

British chariots have been described by Roman historians as consisting of two kinds, called respectively the *covina* and the *esseda*; this last from *esse*, a Celtic word. The former was very heavy and armed with scythes; the latter much lighter, and consequently better calculated for use in situations where it would be difficult to employ the *covina*. Some of these chariots were so contrived that when the warrior dismounted during a battle, he ran along a pole attached to

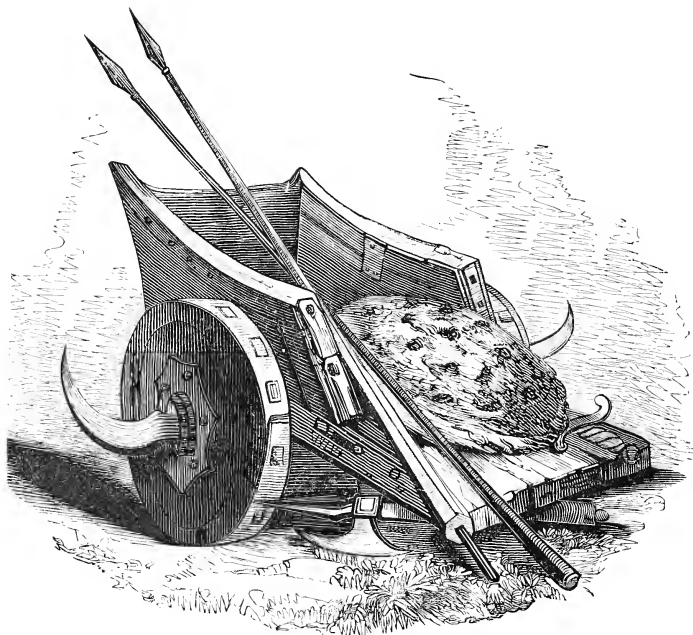

BRITISH COVINA, WITH IMPLEMENTS OF WARFARE.

the side, from whence, or from the yoke, he engaged the enemy, retiring into his chariot again as prudence or choice dictated. Among the Britons the most honorable guided the chariot, while the dependants did the fighting.¹

The *covinas* mounted each a charioteer for driving, and one, two, or

¹ Tacit. in *Agricola*, ch. 12.

more warriors for fighting. These were evidently built exceedingly strong, having the extremities of the axle-tree armed with scythes of a hooked form, as we have elsewhere seen in this volume, contrived for tearing and cutting whatever came in the way while being driven rapidly over the battle-field. The horses of these rude people are said to have reached such perfection in training that they could be driven with speed over the most uneven portions of the country, even through the forests at that period abounding in the island. Such was the celerity of the British chariots that the Romans were perfectly astonished, scarcely knowing how to receive them; so that the British had wellnigh obtained a victory in the first encounter. Subsequent experience, however, on the part of the Romans, provided a remedy against danger from such onsets. When Agricola fought the Caledonians on the Grampian Hills, the barbarian charioteers filled the middle of the field "with tumult and careering." After the battle had begun, the Roman horse in the wings of the army proceeding up the hill, not being able to withstand the shock of the chariots, gave way, and were pursued by the British chariots and horse, which then fell in among the Roman infantry. This last closing in upon the chariots and horse, when they became entangled amidst the inequalities of the ground, were no longer able to wheel and career as upon the open plain, and very soon straggling chariots and affrighted horses without their riders were seen rushing obliquely athwart, or directly through the lines, scattered disorderly over the field.¹

The *essedæ* carried only one person, and are supposed to have been invented by the Belgians, and by them introduced into Britain.² The charioteer was by the Romans called an *essedarius*. Claudius had an *essedæ* so easy-riding that he played a game while traveling.³ In a "Treatise on the Study of Antiquities," by Mr. Pownall, it is said that

¹ Tacit. in *Agricola*, ch. 35, 36.

² *Ibid.*, ch. 35.

³ "Aleam studiosissimæ lusit, de cujus arte librum quoque emisit: solitus etiam in gestatione ludere, ita essedo alveoque adaptatis, ne lusus confunderetur."—SÆT., *Cl.*, 33. "Album incoquitur æreis operibus Galliarum invento, ita ut viæ discerniqueat ab argento, eaque incoctilla vocant. Deinde et argentum incoquere simili modo cœpere, equorum maxime ornamentis jumentorumque jugis in Alexia oppido: reliqua gloria Burturigum fuit. Cœpere deinde, et esseda, et vehicula, et petorita exornare, similique modo ad aurea quoque, non modo argentea, stantia inanis luxuria pervenit: quæque in scyphis cerni prodigum erat, hæc in vehiculis atteri, cultus vocatur."—PLINY, XXXIV, 17.

"the front of the body [of the *essedā*] was made breast-high, and rounded like a shield, so as to answer for the driver the purpose of that defense, and was for that reason called *ἀσπίδιον*, or the shield part.

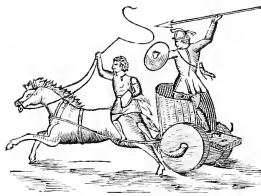

BRITISH ESSEDUM.

The sides of the chariot sloped away backwards almost to the bottom or floor of the body." In reviewing these statements, the Rev. Samuel Pegge, in the seventh volume of the "*Archæologia*," tells us that "it is impossible this should be the figure of the body of the British *essedā*; and therefore, with all due deference to the gentleman's opinion, a distinction should be made between the military chariots used at Troy or in Greece or elsewhere, and those employed by our Britons, which must of necessity have been of a very different figure. In regard to the warriors running along the pole, it is no objection with me that the body of the carriage in the East was low, as Mr. Pownall represents it, because the construction here in Britain might be materially different in that respect from that used anciently there."

The annexed engraving we find in Ginzrot's volume, but doubt its authenticity, the balance of testimony showing the *essedā* to have been open at the back end.

The Roman-British period (A. D. 78 to A. D. 400) furnishes us



ESSEDUM.—AFTER GINZROT.

with very little insight into the progress of art, no writer having given

much attention to this subject.¹ Some years ago, among other curiosities found at Hamden Hill, near the village of Stone-unden-Hamden, at a short distance from the great Foss road which passes from Bath to the sea-coast, several fragments of chariot-wheels were discovered, one of which was quite perfect. It is conjectured that in early times some great battle took place on the hill we have named; for besides the chariot-wheels, a lance, arrow-heads of iron, and human bones were discovered, "amongst which," says our authority, "I observed a skull with a barbed arrow trans-fixed, and I was assured that it was found in that position. I have ever entertained an opinion that the ancient chariots were slight in their texture, and the wheel found here in an almost *entire* state seems to corroborate that idea, as it scarcely exceeds the dimensions of a grinder's wheel."² The spokes were two inches thick and five and a half inches apart at the felloes; the wheel itself being thirty inches in diameter, having twelve spokes in all.



FRAGMENT OF A WHEEL.

Strutt, in his "Manners and Customs of England," mentions a kind of chariot in use among the Anglo-Saxons, which he supposes was derived from the ancient British *essedum*.³ Evidently some progress must have been made in the art of vehicle-construction among these

¹ The original colonists of Britain are supposed to have been from two nomadic tribes, Cimbrians and Celts, which emigrated from the shores of the Thracian Bosphorus to the northern shores of Europe.

² From a paper written in 1823 by Sir Rich. Colt Hare, Bart., F. R. S. and S. A., published in Vol. XXI of the *Archæologia*.

³ The Anglo-Saxon period extends from A. D. 450 to A. D. 1016. In the *Life of St. Erkenwald*, who died in A. D. 865, occurs the following words: "Quandam vero die, verbi Dei pabula, commisso sibi gregi, ministratnus, dum duarum rotarum ferretum vehiculo, infirmatate prepediente, vel seni, contigit ut altera rotassum semitis difficultate axem relinquerit, et ibidem sociâ relictâ remaneret." (See Sir William Dugdale's *Hist. of St. Paul's Cath.*, fol. Apend., p. 5.)

people; although, as is well known, the so-called nobility preferred horseback riding above any other. Concerning the British chariots, Fairholt observes, "It is true that upon the earliest British coinage we have rude chariots delineated, each holding a single rider, but these are only barbaric copies, each worse than its predecessor, of the coins of Philip of Macedon, and resembling, as they also do, the equally rude Gaulish and other coins of Northern nations, can only be received at the utmost as proofs of the universality of chariot-riding, and not as particular types of any one nation's peculiar chariot. Before we take even coins or ancient monuments as authority for any one nation, we must be sure that they are the genuine products of that nation, uninfluenced by foreign conventionalities."¹

The writer previously quoted mentions "that the Roman war-chariot was doubtless well known in Britain after its subjugation"; and it has been supposed that the Saxon chariot, of which an illustration is

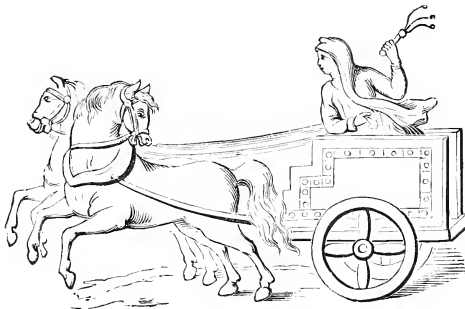

SAXON CHARIOT.²

annexed, is but a rude imitation of the biga of classic fame. As we have nowhere in our researches found any proof that chariots as instruments of war were employed by the Romans, the simple opinion of a modern author has but little value. The illustration

probably represents some vehicle used by the higher class of our Saxon ancestors, having no connection whatever with warfare. The charioteer is evidently a female, and this alone is proof sufficient that it was designed for pacific purposes. Indeed, as Strutt informs us, "the *chaep*, or chariot, of the Anglo-Saxons was used on civil occasions for the conveyance of distinguished personages, the others riding in carts."

¹ London *Art Union Journal*, 1847, p. 119.

² From the *Cottonian MSS.*, *Cleopatra*, C, 4, British Museum.

The existence of hooks and scythes especially to British chariots has been disputed, since neither Cæsar, Tacitus, nor any other contemporaneous writer, except Pomponius Mela, who wrote in the first century, mentions the fact. Weapons answering the description of such instruments, however, have been found on ancient battle-fields. It is also recorded that, between the time of Cæsar's invasion and that afterwards ordered by Claudius, these British chariots attracted notice and were exhibited as curiosities in Italy, and shown in the splendid pageantry with which Caligula passed over the sea from Puteoli to Baïæ, on a bridge framed of boats. Suetonius tells us that he himself rode in a chariot of British construction, followed by a party of friends. These chariots were undoubtedly British trophies captured by the Romans. In after times these war-chariots were frequently alluded to by the historians and poets of Rome. A great fondness for horses, and skill in riding and accustoming them to drawing cars and chariots, appear to have prevailed among all the Celtic tribes of the British Isles.

A manuscript in the British Museum, supposed to have been written by Elfricus, Abbot of Mahisbury, in the tenth century, contains the rude drawing of an Anglo-Saxon machine, on which a great waste of ink has been made in discussing the question as to whether it should be taken as the simple representation of a wheel-bed for travel to the "Land of Nod," or a veritable carriage for wide-awake people. A copy of it, called by Strutt a four-wheeled hammock, is here shown. The occupant, of colossal proportions in comparison with the machine, is clothed with an ordinary Saxon tunic, having wrinkled sleeves, and hands extended as though engaged in her evening devotions, which seems to favor the idea of its being intended for a bed on wheels. Indeed, the hammock-like shape of the body, depending from hooks in the posts, rather confirms such an opinion. As a late writer observes, supposing it to represent a carriage, "The patient,

HAMMOCK CARRIAGE.¹

¹ Cottonian MSS., Claudius, B, 4, British Museum.

we will not call her the traveler, got in, and then she must have had to endure an amount of shaking and banging which is positively terrible to imagine. In the state of the roads at that date, what could have saved the unhappy passenger from continued and horrible concussion of the wheels?"¹

In common with other nations, our Anglo-Saxon ancestors were compelled, in cultivating the soil,



ANGLO-SAXON CART.²

to employ in the first stages of colonization vehicles, often of the rudest construction, from which the linnens of the age are supposed to have taken their models. The annexed engraving of an Anglo-Saxon cart is the product of such circumstances. The venerable passenger is supposed to represent the patriarch Jacob on the journey from Canaan into

Egypt, the picture itself being copied from a manuscript Pentateuch of the tenth century. The "royal personage," as he is called in the parchment, bears the same disproportion with the team that character-

¹ Apropos of wheeled beds, Markland tells us that "in Harmar's translation of Beza's Sermons upon the three first chapters of the Canticles, printed 1587 (Ser. XXVIII, p. 374), a passage reads, 'King Solomon made himself a *coche* of the wood of Lebanon.' (Ch. iii, v. 9.) This word has at different times been rendered *palace-bed*, and, in the authorized version, *chariot*. In Wickliff's, it is a *chaier*; in the Vulgate, *feculum*. The Hebrew makes it a *bridal-couch*, or room. This tends to prove that the true derivation of the word [coach] is from *coucher*, and that it implied originally a movable couch or bed. We need not, therefore, resort, with Minsheu, for the etymology of the word, to *Kötzsche* (*a verbo Hungarico Kotozy*), or to *Couchey*, the Cambridge carrier; yet the following passage, selected from the *Diary of Custinian*, Mayor of Vienna (which I owe to the researches of my friend, Mr. Douce), goes to establish the former. The writer, in speaking of a visit made to that city in 1515, by Maximilian, and the kings of Hungary, Bohemia, and Poland, says, 'Ingrediebantur toto die Viennam currus, quadrigæ et bigæ Hungarorum, et Polonorum. Vehabantur multi in curribus illis velocibus, quibus nomen est patriæ linguâ Kottschl.' (Vide *Germanicorum verum Scriptores viri Margardi Freheri*, 1637, fol. ii, p. 312.)" In this connection it may be mentioned that a volume entitled *The Triumph of Maximilian*, written by J. Burgkmair during the years 1516, 1517, and 1518, is still extant, where we are told "the curious reader will find plates of various carriages or cars, some drawn by horses, some by camels, some by stags, and others impelled forward by means of different combinations of toothed wheels, worked by men."

² From the *Cottonian MSS.*, *Claudius*, B, 4, British Museum.

izes the last figure, both being the work of the same hand. Such is the rudeness of the drawing that it is difficult to determine the species of the draft-animals. Probably they were designed to represent mules.

A different kind of cart is shown in the next engraving, unquestionably designed for business purposes. The construction is very simple, consisting of a long, heavy, flat board made fast to the axle-tree, and supported by two heavy high wheels. In the original picture a single horse, attached to the chain, is driven by a man standing on the plank body.

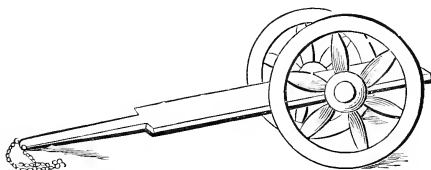
ANGLO-SAXON TRUCK.¹

The next engraving represents an Anglo-Saxon harvest-scene, taken from a work illustrative of the seasons. The cart, which is a prominent figure in the picture, is of much later date than the preceding, probably belonging to the eleventh century. It is remarkable in being open at both ends of the body, and having the sides ornamentally

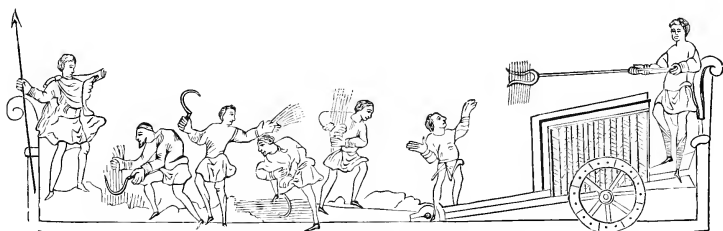

CART, WITH ANGLO-SAXON HARVEST-SCENE.

painted. The projections in the rear, which support the man manipulating the pitchfork, are novelties we do not remember to have elsewhere seen. This vehicle was used as a horse-cart, if the construction of the thills prove anything.

The Norman knights, taking especial pride in horsemanship in their own country, looked upon any other mode of conveyance as disgrace-

¹ From the *Cottonian MSS.*, *Tiberias*, B, 5, British Museum.

ful effeminacy, even among the ladies; but when the Conqueror and his followers came into England, they introduced the horse-litter, a mode of conveyance employed more or less until the days of King John (A. D. 1206-1216). This mode of travel is said to have been

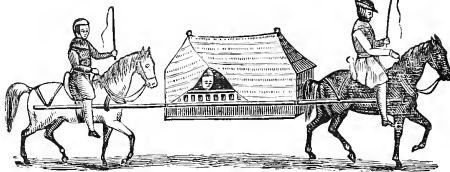

HORSE-LITTER OF THE TIME OF EDWARD III.

invented in Bythinia, and from thence introduced into Rome, where it is still used by the Pope on special occasions, and also in Spain, Portugal, and the mountain-passes of Sicily.

The horse-litter at one period was used by persons of the most exalted station in life. William of Mahusbury says that the body of William Rufus was placed upon a *rheda caballaria*, a kind of horse-chariot, or as Fabian translates it, horse-litter; and King John, according to Matthew of Westminster, was conveyed from Swinshed in *lectica equestri*, i. e., the horse-litter. When Queen Margaret, daughter of Henry VII, visited Scotland, she is described as riding on a "faire palfrey," but following her was "conveyed by two footmen one very riche litere, borne by two faire coursers varey nobly drest, in the wich litere the sayd quene was borne in the intrying of the good townes, or otherways to her good playsur." Behind came "a char richly drest, with sixe faire horsys leyd and conveyed by thre men, in the wich were four ladyes lasting the sayd voyage."¹

As late as 1589, Sir Francis Willoughby applied to the Countess of Shrewsbury for her horse-litter and furniture for the use of his wife, who being sick could neither travel "on horseback or in a coche." The use of litters as state carriages continued until the times of Charles I. The latest mention of them is by Evelyn in 1640.²

In the course of time, the gallant Normans, considering it disgraceful for the ladies to use litters, invented a sort of chariot, which they called *chares*, for their special use. These chares appear to have been the earliest pleasure-carriages used in England, and the prototypes of close carriages. That chares were conveyances distinct from litters is evident from the list of presents made in 1604 by the Duke of Florence

¹ See Leland's *Collectanea*, IV, p. 267.

² Evelyn's *Diary*, Vol. I, p. 9.

to the royal family, where they are thus particularized: "To the Queene 11 moyles and a litter; to the Prince a verie fayre chayre."¹

In a curious old Latin poem by Richard of Maidstone, on the reconciliation (about 1381) between Richard II and the citizens of London, the queen, in her ceremonious entrance with her husband into the capital, is represented as having two chares with ladies in her train; and the writer tells us, rather exultingly, how one of them was overturned, whereby the persons of the ladies were exposed to the gaze of the multitude, which he looks upon as a punishment for their presumption.² These chares in after times became extremely popular, being frequently alluded to by historians and poets. An unedited old version of Scripture history, entitled "Curror Mundi," quoted in Hallowell's "Dictionary of Archaic and Provincial Words," when describing how Joseph sent to fetch his father into Egypt, has the following lines:—

"Nay, sir, but ye not to him fare,
He hath not sent aftir the his *chare* :
We shul you make they une a bed,
Into Egypte ye shul be led."³

In "The Sqyr of Low Degree," supposed to have been written before Chaucer's time, the father of the Princess of Hungary promises her that if she would forget him for whom her heart

"was grieved, as only maids could be,
That love, and loose like her, a squire of low degree,"

that,

"To-morrow we ride with all our train,
To meet our cousin of Aquitaine ;
Be ready, daughter, to go with us there
At the head of the train in a *royal chair*.
The chair shall be covered with velvet red,
With a fringed canopy overhead,
And curtains of damask, white and blue,
Figured with lilies and silver dew ;

¹ Hunter's *Hallamshire*, p. 94.

² "Namque sequenter cum currus duo cum dorminabus ;
Rexerant hos phaeton unos enim cecedit.
Femina feminea sua dum sic femina nudat,
Vix posterat risum plebs retinere suum.
Currus est iste placet, veniat, rogo quod mihi signet,
Covinant ut luxus et malus omnis amor."

³ Hallowell's *Dictionary*, p. 192.

Purple your robe, with ermine bands ;
 The finest fir of the northern lands ;
 Enameled chains of rare devise,
 And your feather a bird of paradise !
 And what will you have for a dainty steed ?
 A Flanders mare¹ of the royal breed ?
 An English blood ? a jennet of Spain ?
 Or a Barbary foal with a coal-black mane ?
 We still have the Soldan's harness, sweet !
 The housings hung to the horses' feet,
 The saddle-cloth is sown with moons,
 And the bridle-bells jingle the blithest tunes."²

But, as has been the case with many "maids" since, whose "rosy cheeks have been by the soft winds kissed," the princess preferred her "squyr of low degree" to all other enjoyments, —

"' But I would rather,' says she,
 ' My loving squyr of low degree.
 Not a gaudy *chair* nor days of chase
 Reward me for his absent face.'"

Chaucer, in describing the "char" of Zenobia, says it was

" With gold wrought and pierric";³

and likewise mentions

" The char of gold of the King of Thrace."⁴

Skelton thus alludes to them : —

" Nowe all the world stares
 How they ryde in goodly chares."⁵

Another kind of carriage in use at this time was called the *whirlicote*. Stow, when relating the history of Wat Tyler's rebellion, which happened in 1380, tells us that Richard II, "being threatened by the rebels of Kent, rode from the Tower of London to Mile-end, and with his mother, because she was sick and weak, in a whirlicote of *old time*." It would seem from the latter part of the clause that whirlicotes, whatever they may have been, had been long in fashion. The

¹ When Cromwell, in 1649, set out for Ireland, he rode in a coach with "six gallant Flanders mares, whitish-gray, divers coaches accompanying him." — CARLYLE'S *Letters and Speeches of Oliver Cromwell*. In a curious will, made in 1506, by Robert Jakes, of Leicestershire, he gives, "To my daughter Jane Waryng an amblyng mare, of candell color, with a fole."

² Ellis's *Specimens of Early English Poetry*.

⁴ *Canterbury Tales*, v. 2140.

³ *Canterbury Tales*, v. 14366.

⁵ *Colin Clout*, l. 963.

same author says that "coaches were not known in this island [England], but chariots or whirlicotes, then so called; and they only used of princes, or men of great estates, such as had their footmen about them. The next year after Richard had married Anne of Bohemia, she introduced the fashion of riding on horseback; and so was the riding of these whirlicotes and chariots forsaken, except at coronations and such like spectacles."¹ But we are anticipating chronology, and must go back a few years.

Near the middle of the fourteenth century,² the *long-wagon*, shown in the annexed illustration, became very popular as a traveling carriage, and when used by persons of high rank was frequently richly decorated, and the most interesting vehicle of the period. Our engraving is copied from an illumination in the famous psalter executed for Sir Geoffrey Louttrell. The vehicle is drawn by five horses hitched together by ropes in a very simple manner, guided by two riders, each carrying whips of different lengths. The wagon carries coronated dames, one of whom, seated in front, has a squirrel sitting on her shoulder, another, behind, receives a pet dog from a mounted cavalier. The bows or ribs, which support a richly constructed covering, are nicely arched, the faulty perspective showing longitudinal bars or stays, the ends of which terminate in carvings representing grotesque heads. The head has two openings in each side, answering the purpose of windows or lookouts for the convenience of the inside passengers. The birds in front and

LONG-WAGON OF THE FOURTEENTH CENTURY.

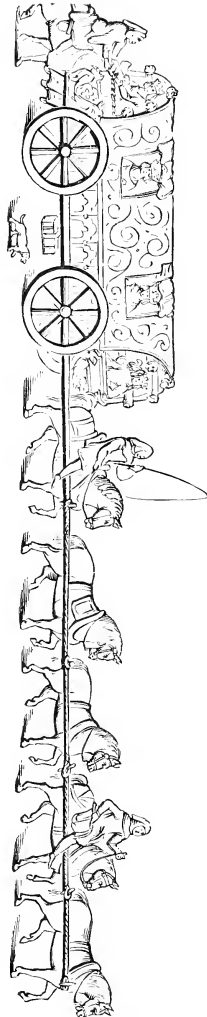

¹ Stow's *Chronicle*.

² *Temp.* Henry VI.

rear serve as additional ornaments to the whole, while the chest beneath the reach is very useful as the deposit for tools required in repairing damages caused by the uneven roads of former days. The old English talbot trotting beside the vehicle is a suitable representative of the canine species of the ancients, as we have previously seen. Such vehicles, nicely fitted out with soft cushions and beds, although deficient in springs, must have proved very comfortable turnouts in the earlier days of travel.

Markland supposes that the horse-litter and chaire were the most ancient vehicles of travel in use among the nobility of England, and that these were seldom employed except in cases of sickness or on ceremonial occasions, and that the chariot which Mr. Pegge¹ regards "as the elder vehicle, or rather the coach in its infancy," was originally nothing more than a wagon or cart. Probably the word "chariot" primarily signified nothing more than *a wagon*, as it is thus rendered in Cottgrave's Dictionary, published as late as 1632; also, in some passages of Scripture. Where, in the authorized translation, mention is made of wagons, the earlier versions read *charett*, or chariot; in the Vulgate, it is *plaustra*; and in Wickliff's version, *waynes*.

Markland, before named, to whose industry we are indebted for much of the knowledge we have on this subject, fittingly observes that "the reign of Elizabeth [1558-1603] is generally cited as the period when coaches were introduced into England"; and under that term carriages of every kind have been considered as included; but long anterior to her reign vehicles on wheels, under the names of chaires, cars, chariots, carroaches,² and whirlicotes, were used in the island.

¹ See Dr. Samuel Pegge's *Anecdotes of Old Times*, pp. 273-275.

² Some authors tell us that *coach* and *carroach* were terms formerly applied to the same carriage. This, however, may be disputed, since John Taylor, in the passage at the head of this chapter, mentions both in the same line. In describing a visit he made to Prague in 1616, he informs us, —

" Their *coaches* and *carroaches* are so rife,
They doe attend on every tradesman's wife."

The idea that two different vehicles are meant is strengthened by the following lines from Green's *Tu Quoque*, 6, P. VII, 28: —

" Nay for a need, out of his easy nature,
Mayst draw him to the keeping of a *coach*
For country, and *carroach* for London."

In the well-known letter of Lady Compton, the rich heiress of Sir John Spencer, writ-

Indeed, it is sufficiently obvious that a people progressive in civilization, and having commercial intercourse with other nations, where they abounded, would not long remain without importing, or manufacturing for themselves, luxuries such as carriages manifestly are, even in the face of prejudice.

Erroneous conclusions have frequently been drawn by not attending carefully to terms which in the lapse of time often change their significance. In the "Northumberland Household Book" almost every species of vehicle is called a "carriage," with the exception of the earl's chariot, and this was not employed to carry persons, but certain parts of "the chapell stuff" and "wardrobe stuff." From this application of the word "chariot," it is evident, as Bishop Percy observes, "that it bore no resemblance to the modern carriage of that name, nor was it intended for the same use, but was simply a large wagon drawn by six horses, called on that account 'large trotting horses.' The chariotmen, or wagoners, who accompanied it, had a nag or smaller horse allowed them to ride by its side." Markland says that "Dr. Percy's statement is strengthened by a document which Mr. Ellis pointed out to him amongst the Cottonian Charters (XI, 71), whereby Anne, the queen of Richard II (1377-1400), in the seventeenth year of that king's reign, granted an annual stipend of forty shillings during her life to Robert Westende, '*pourvoir de noz charriette.*'" If these carriages were to be provided *yearly* and in *numbers*, it seems obvious that they must have been required for the conveyance of other things than of persons.¹

Covered chariots, with ladies therein, followed the litter of Katherine on her coronation with Henry VIII, and likewise Anne Boleyn when she rode through London. The "bloody" Queen Mary went in state to Westminster in 1553, "sitting in a chariot of cloth of tissue,"²

ten at the commencement of the seventeenth century, we find that among other moderate stipulations, that lady requests two *coaches* for her own use, and a third for her women, and also "att any tyme when I travayle, I will be allowed not only *carroaches*, and spare horses for me and my women, but will have such *carryadges* as shall be fitting for me, all orderly." Markland, in the *Archæologia* (Vol. XX, p. 446), says, "The latter were for conveying her own wardrobe and that of her women, and that the words soon became confounded, and *coach*, with occasional exceptions, was the word generally used." Dr. Baillie, in his *Wall-flower, written in Newgate* (1659), uses the word *carroach* for *coach*.

¹ See a paper in *The Archæologia*, Vol. XX, pp. 449, 450.

² Froissart, in relating the return of the English from an incursion into Scotland

drawn with six horses.”¹ Sir Edward Hastings immediately afterwards leading her horse in his hand, and then followed another chariot with cloth of silver and six horses, containing Elizabeth and Anne of Cleves. Even Queen Elizabeth on her coronation rode to Westminster in a chariot. Harrison, in mentioning the vehicles in use during the earlier years (1564) of this queen’s reign, calls them *cartes*, as expressive of their ill construction. In his “Description of Britain,” prefixed to Hollingshed’s Chronicle, he says, “It is to be noted that our princes and nobility have their carriages commonlie made of cartes, whereby it cometh to passe, that when the Queen’s Majestie doth remoite [remove] from anie one place to another, there are usuallie four hundred carewares which amount to the somme of two thousand four hundred horses, appointed out of the countie adjoining, whereby her carriage is conveied safelie unto the appointed place.”

On the authority of Stow, it is generally believed that coaches were first introduced into England during the reign of Elizabeth. This is doubtful. In an old ballad (*temp.* Edward I, 1272–1307) entitled “A Warning Piece to England against Pride and Wickedness, being the fall of Queen Eleanor,² wife to Edward First, king of England, who for her pride, by God’s Judgments, sunk into the ground at Charing-cross, and rose at Queenshithe,” it is said, —

“She was the first that did invent,
In coaches brave to ride;
She was the first that brought this land
To deadly sin and pride.”

under Edward III (1327), says, “En celle cité (Durennes) trouverent ils leurs *charrettes* et tout leur *charroy*, qu’ils avoient laissé xxxij jours au devant, en un bois, à minuict si comme il est racompté cydessus : et les avoient burgeois de durennes tronvez et amenez en leur ville, à leurs ceusts et fait mettre en vuïdes graches, *chacune charrette à son pé noncel, pour les recognoistre*. Si furent moult joveux les seigneurs, quand ils carent trouvé leur charroy.”—FROISSART’S *Chronicles*, Paris, 1574, Tom. I, ch. 19.

¹ D’Avenant’s *Works*, fol. 1673, p. 351, etc.

² Queen Eleanor died Nov. 28, 1291, at Hareby, in Lincolnshire. Her remains were carried in profuse state to London, and deposited in Westminster Abbey, where a monument is erected to her memory. On each spot where the body rested on its way, the king afterwards caused crosses to be erected. They were known as Lincoln, Grantham, Stopford, Geddington, Northampton, Thorny-Stratford, Waltham, Tottenham, and Charing Crosses, the last of which stands, on a modern pedestal, in the court-yard of the Charing Cross railway station in London.

Two years before Elizabeth came to the throne (in 1556), "Sir T. Hoby offered the use of his coach to Lady Cecil." Mr. Douce observes that "although this quotation from the 'Burleigh Papers' (III, No. 53) presents probably the earliest *specific date* of the use of coaches in England, we must infer that they were known before, though probably not long before. Bishop Kennet, in a note that I found among his papers, mentions that J. Chamberlayne, Esq., of Petty, France, has a picture of his grandfather, on which is this inscription, 'Sir Thomas Chamberlayne, of Prestbury, in Gloucestershire, Ambass^r from England to Charles V, Philip II, and to the King of Sweden, in Flanders. He married a lady of the house of Nassau, and from *thence* also he brought the *first* coaches and the *first* watches that were ever seen in England.' He was born in the reign of Edward IV, and died in the reign of Queen Elizabeth. This curious inscription, therefore, leaves the *exact time* of the introduction of coaches into England in a state of uncertainty."¹

We now introduce Stow's record. Under date of 1555, Stow says, "This year Walter Rippon made a coche for the Earle of Rutland, which was the first coche that ever was made in England." So it appears, contrary to the general belief, Queen Elizabeth did not get the first coach made in England, "since, to wit *in anno* 1564 [nine



QUEEN ELIZABETH'S COACH, RIPPON, MAKER.

years later], the said Walter Rippon made the first hollow turning coche for her Majesty, being then her servant." The above engraving is supposed to represent the first coach owned by the queen, William

¹ *Archæologia*, Vol. XX, p. 493, note.

Boonen being coachman; for previous to this it is said "that she was accustomed to ride on horseback behind her Lord Chamberlain on all state occasions, Her Majesty's attendants being likewise provided with horses." The only objection we have found to this supposition is the statement that when Queen Elizabeth visited Warwick in 1572, the buliff is said to have "approached nere the coche or chariot wherein her Majesty sat," and the queen "caused every part and side to be opened, that her subjects present might behold her which most gladly they desired."¹ On looking at this coach it is quite natural to conclude that it was already *enough open*, unless the sides were supplied with curtains, which most likely was the case. Among the "Two Thousand Wonderful Things," by Edmund F. King, is shown a drawing which he says "is taken from a very old print, representing the state procession of Queen Elizabeth, on her way to open Parliament, on April 2, 1571." This was the first occasion on which a state coach had ever been used by a sovereign of England, and it was the only vehicle in the procession. He tells us that William Boonen was still the coachman at this time.

Later, in 1582, the English ambassador to the French court writes to Elizabeth, saying, "The French King hath commanded to be made for your Majesty an exceeding marvelous princely coche, and to be

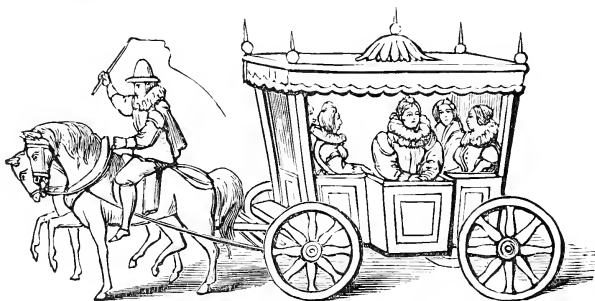

QUEEN ELIZABETH'S FRENCH COACH.

provided foure of the fairest moiles which are to be had, for to carry your Highness's litter. The king hath been moved to shew himself in this sort, grateful to your Majesty on receiving those dogs and other

¹ Hollinshed's *Chronicle*, IV, p. 6.

singularities you were lately pleased to send unto him for his falconer.”¹ In the same year, Hoefnagel's print, from which these two coaches were taken, was published, a copy of which is preserved at Nonsuch Palace. A reduced copy is annexed. It is evident that Hoefnagel, in this print, intended to represent both the English and French coaches then in possession of the queen, there being no proof of her having any other up to this time, unless we admit that she received one from Holland with Boonen, which is extremely doubtful.

Soon after our return from abroad in 1873, we sent a communication to “The Antiquary,” then published in London, the object of which was to ventilate this whole subject. To this several responses were made, some of them by persons known as prominent writers, without furnishing anything new. On reflection, we have come to the conclusion that the English of the present day have but very *foggy* notions regarding this history of Queen Elizabeth's coach, which we trust will be dispelled by our research.

The following, from the Household Book of the Kyston family, is interesting as giving the cost of a coach during the reign of Elizabeth, in 1572. It reads thus: “For my m^{res}. Coche, with all the furniture thereto belonging except horses — xxxiiij *li*. xiiij *s*. For y^e painting of my m^r. and my m^{res}. armes upon the coche — ij *s*. vj *d*. For y^e coche horses bought of Mr. Paxton — xj *li*. xxii *s*. iii *d*.”

Among the inventory of goods left after the death of Archbishop Parker, who died in 1577, his executors enumerate two coaches, “one covered with lether, and furniture for ij horses to the same; the other

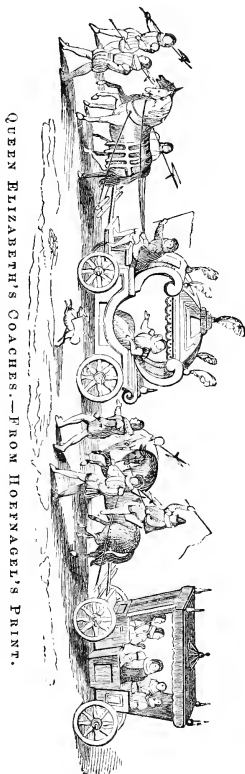

QUEEN ELIZABETH'S COACHES.—FROM HOEFNAGEL'S PRINT.

¹ Strype's *Annals* (2d edition), Vol. III, p. 78.

uncovered, with like furniture," from which it would seem that the more able were beginning to imitate the queen in this particular. Still, as an old chronicler informs us, "Coaches being yet uncommon, and hired coaches not at all in use, those that were too proud or idle to walk, went to the theaters on horseback,"¹ the women only riding in the coaches, according to Aubrey. This writer assures us that in Sir Philip Sidney's time (he will be remembered as one of Elizabeth's favorites), so famous for men-at-arms, it was then held to be as great a disgrace for a young gentleman to be seen riding in the street in a coach, as it would now for such a one to be seen in the street in a petticoat and waistcoat, so much is the fashion of the times altered. But says another, "After a while divers great ladies, with a great jealousy of the Queen's displeasure, made them coaches and rid in them, up and downe the countries, to the great admiration of the beholders; but then, by little and little, they grew usual among the nobilitie, and others of sort, and within twentie yeares became a great trade of coach-making."

¹ When Shakespeare lived in London to escape his debtors, he held the horses of such as had no servants, when they came out of the theater at the close of a performance. In time, when business increased (and he could hold only one at a time), he hired boys to assist him. These, when Shakespeare's name was called, stepped forward with no little pride, saying, "I am Shakespeare's boy, sir."

A few years previous to this (*circa* 1544), the celebrated Tobias Hobson was born, dying in 1630. In No. 509 of *The Spectator* we are informed that he was the first man in England who let out hackney horses; that "he lived in Cambridge, and observing that the scholars rid hard, his manner was to keep a large stable of horses, with boots, bridles, and whips, to furnish the gentlemen at once, without going from college to college to borrow, as they have done since the death of this worthy man. . . . Mr. Hobson kept a stable of forty good cattle, always ready and fit for traveling; but when a man came for a horse, he was led into the stable, where there was great choice; but he obliged him to take the horse which stood next to the stable-door, so that every customer was alike well served according to his chance, and every horse ridden with the same justice." From this comes the proverb, "Hobson's choice," *i. e.*, *no choice at all*. Milton, knowing him personally, wrote two epitaphs to his memory. One of them runs thus:—

"Here lies old Hobson; death has broke his girt;
And here, alas! hath lain him in the dirt;
Or else, the ways being foul, twenty to one
He's here stuck in a slough and overthrown.
'T was such a shifter, that if truth were known,
Death was half glad when he had got him down;
For he had, any time this ten years full,
Dodged with him betwixt Cambridge and the Bull."

There was one man, however, whose courage was undaunted. Smiles informs us that "that valyant knight, Sir Henry Sidney, on a certain day in 1588, entered Shrewsbury in his wagon, with his trumpeter blowynge, very joyful to behold." This *indiscretion* on the part of the knight, and the increasing use of coaches, seem to have awakened censure in the writers of the day. In a volume entitled "Pleasant Quippes for upstart new-fangled Gentlewomen," by some attributed to Master Stephen Gosson, by others to Nicholas Breton, published in 1595, the writer thus takes hold of those who patronize the coaches:—

" To carry all this pelfe and trash,
Because their bodies are unfit,
Our wantons now in coaches dash
From house to house, from street to street.
Were they of state, or were they lame,
To ride in coach they need not shame."

Even the good Bishop Hall must have a fling at them in his "Satires," published in 1597, stigmatizing the use of coaches as "sin-gentility," and dealing out to the "groome" a blow at the same time. He thus inquires:—

" Is't not a shame to see each groome
Sit perched in an idle chariot roome,
That were not meete some panel to bestride,
Sursingled to a galled hackney's hide?"¹

But time, which is said to work wonders, was slowly but surely *working* in favor of the coaches. "They of state" were lending countenance to the "sin-gentility," as the bishop termed the use of coaches. Four coaches accompanied an embassy to Morocco, through the city of London, in 1600, and an embassy to Russia in the same year was attended by eight. Three years later the members of a French mission of congratulation on the ascension of James I all rode in coaches, to the number of thirty, from the Tower Wharf to the ambassador's

¹ Spenser, in the second portion of the *Faerie Queene*, published about this time, thus alludes to coaches, chariots, etc.:—

" Tho' up him taking in their tender hands,
They easely unto her charett beare;
Her teame at her commaundement quiet stands,
Whiles they the corse into her wagon reare,
And strowe with flowers the lamentable beare;
Then all the rest into their coches clim," etc.

dwelling in Barbican, and returned to their lodgings in Bishopsgate Street in the evening, to the admiration of the citizens. Such was the increasing popularity that on the 7th of November, 1601, "A Bill to *restrain* the excessive use of Coaches within this realm of England," was read, *secundâ vice*, in Parliament, but rejected. "Hereupon," says the historian, "motion was made by the Lord Keeper, that forasmuch as the said Bill did in some sort concern the maintenance of horses within this realm, consideration might be had of the statutes heretofore made and ordained touching the breed and maintenance of horses.¹ And that Mr. Attorney-generall should peruse and consider of the said Statutes, and of some fit Bill to be drawn and prefer'd to the house touching the same, *and concerning the use of coaches*; and that he should acquaint therewith the committees appointed for the Bill before mentioned, for assurance of lands;² which motion was opposed by the House."³

Maepherson⁴ informs us that in four years thereafter (in 1605) "the coaches began to be in pretty general use among the nobility and gentry in London, and the watermen were not tardy in exclaiming against a fashion so prejudicial to their calling." One "sculler [on the Thames] told him he was now out of cash; it was a hard time; he doubts there is some secret bridge made to hell, and that they steal thither in coaches, for any Justice's wife and the wife of every Cittizin must be jolted now."⁵ "Coaches and sedans," says another waterman, "they deserve bothe to be throwne into the Theames, and but for stopping the channel, I would they were; for I am sure where I was wont to have eight or tenne fares in a morning, I now scarce get two in a whole day. Our wives and children at home are readie to pine, and some of us are faine for meanes to take other professions upon us."

But the coaches still increased in spite of opposition, until, as one writer informs us, "they pestered the streets, so greatly did they at this time breed and multiply." Indeed, it was charged that the Gunpowder treason and coaches were both hatched from the same nest.

¹ 27 Henry VIII, ch. 6; 32 Henry VIII, ch. 13; and 8 Elizabeth, ch. 8.

² See 44 Elizabeth, ch. 1.

³ D'Ewe's *Journals of all the Parliaments*, during the reign of Queen Elizabeth (edit. 1682), p. 602.

⁴ *Annals of Commerce*, Vol. II, p. 167.

⁵ See *A Knight's Conjuring done in Earnest, discovered in Jest*, by Thomas Dekker, London, 1607.

Those who had been accustomed to trudge through miry streets and on horseback, and now had the means, were not long in appropriating the new luxury to their use. If they did not order a coach made, yet they did not fail to hire one when fancy or convenience required it. In an old poem entitled "Christmas Lamentations," published about this time, such was the rage for this species of amusement, that we are told,

"Madam, forsooth, in her coach must wheele,
Although she wear her hose out at the heele!"

About the year 1610, a person in Scotland, said to have been a native of Stalsund in Pomerania, offered to contract for a certain number of coaches and wagons, with horses to draw and servants to attend them. Accordingly, a royal patent was granted him conferring an exclusive privilege for fifteen years of running them between Edinburgh and Leith. This is probably the earliest instance where a vehicle entitled to the name of a stage-coach was ever run in the United Kingdom.

The next illustration is taken from Visscher's "Views in London," published at Antwerp in 1616. This engraving is particularly interesting, affording, as it does, the earliest representation of a baggage-rack behind a coach, although the design looks more like an omnibus than its "older brother." It is likewise remarkable as being drawn by only one horse, and that besides being burdened with the driver on his back! But there were no Berghs in those days.

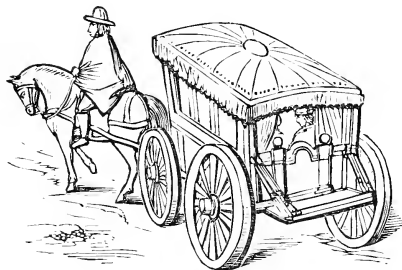

ENGLISH COACH OF 1616.

In "Fyne Morrison's Itinerary, or Ten Years' Travel throughout Great Britain and other Parts of Europe," published in 1617, we have a pen-picture which in this connection is of some interest. He tells us that "in England towards the south, and in the west parts, and from London to Berwick upon the confines of Scotland, post-horses are established at every ten miles or thereabout, on which travelers ride a false gallop at the rate of ten miles an hour sometimes, but that

makes their hire the greater. With a commission from the chief postmaster or chief lords of the council (given either on public business or the pretense of it), a passenger pays twopence-halfpenny a mile for his horse, and the same for his guide's horse; but if several persons travel in company, one guide will do for the whole. Other persons, who have no such commission, must pay threepence a mile.

“This extraordinary charge for horse-hire is well recompensed by the greater speed of the journey, by which the increased expense of inns in slow traveling is avoided. All the difficulty is in bearing the great fatigue. The traveler is at no expense for the food of these horses; but at the end of ten miles, the boy who takes them back expects a few pence in the way of a gift. For the most part, Englishmen, especially in long journeys, ride their own horses. But if any person wishes to hire a horse at London, he pays two shillings the first day, and twelve or perhaps eighteen pence a day afterward, till the horse is brought back to the owner. In other parts of England a man may hire a horse for twelve pence a day, finding him meat; and if the journey be long, he may hire him at a convenient rate for a month or two. Likewise carriers let horses from city to city, bargaining that the passengers must put up at their inns, that they may look to the feeding of their horses. They will thus lend a horse for a five or six days' journey, and find the animal meat themselves, for about twenty shillings. Lastly, these carriers have long, covered wagons, in which they carry passengers from city to city; but this kind of journeying is very tedious, for they take wagon very early, and come very late to their inns, so that none but women and people of inferior condition travel in this sort. Coaches are not to be hired anywhere but at London; and although England is for the most part plain, or consisting of little pleasant hills, yet the ways far from London are so dirty that hired coachmen do not ordinarily take any long journeys. For a day's journey, a coach with two horses is let for about ten shillings a day, or some fifteen shillings a day for three horses, the coachman finding the horses' meat; if the journey be short, about eight shillings will suffice, but then the passengers pay for the meat of the horse. One horse's meat will cost twelve pence or eighteen pence for one night, for hay, oats, and straw; but in summer they are put to grass at three pence each, although those who ride long journeys keep

them in the stable on hard meat, as in winter, or else give them a feed of oats when they come from grass in the morning."

About the year 1619, a royal favorite, the Duke of Buckingham, ambitious for display, carried his pomp so far as to drive six horses before his coach. One author says this action was "wondered at then as a great novelty, and imputed to him as a masterly pride."¹ From this circumstance arose the phrase, "A coach and six."

And now comes the storm against the "increase of coaches" from the watermen of the Thames, who, like the shrine-makers of Ephesus in former days, imagined their craft endangered. John Taylor, known as the "water

poet," sympathizing with them, in consequence of his employment on the river in his earlier life, took up their cause, and put forth a curious pamphlet derogatory to coaches and in favor of carts.² This was accompanied by a singular engraving, which is here reproduced from photograph of the original, slightly reduced in size. Here the world is represented as being drawn in a fancifully designed chariot by Satan and an abandoned woman.



TAYLOR'S WORLD ON WHEELS.

poet," sympathizing with them, in consequence of his employment on the river in his earlier life, took up their cause, and put forth a curious pamphlet derogatory to coaches and in favor of carts.² This was accompanied by a singular engraving, which is here reproduced from photograph of the original, slightly reduced in size. Here the world is represented as being drawn in a fancifully designed chariot by Satan and an abandoned woman. The fan in the woman's hand, and the protruding

¹ Wilson's *Life of King James*, fol., p. 130, London, 1653.

² The copy in the Library of the British Museum is entitled *The World runnes on Wheels; or, Oddes betwixt Carts and Coaches*. London, printed by E. A. for Henry Gosson, 1623. This is dedicated "To the noble Company of Cordwainers, the worshipfull Company of Sadlers and Woodmongers; To the worthy, honest, and lawdable Company of Water-men, And to the sacred society of Ilackncy-men, And finally to as many as are grieved and vnjustly impouerished and molested with 'The Worlds Running on Wheels.'" The work consists of about thirty pages octavo.

tongue of the archfiend indicate that they have a laborious task to perform. The following doggerel is given as the meaning of the "Embleme" by Taylor:—

"The *Dieull*, the *Flesh*, the *World* dothe Man oppose,
 And are his mighty and his mortall foes:
 The *Deuill* and the Whorish *Flesh* drawes still,
 The *World* on *Wheeles* runnes after with good will,
 For that which wee the *World* may justly call
 (I mean the lower *Globe Terrestrial*),
 Is (as the *Dieull*, and a whore doth please)
 Drawne here and there, and euerywhere with ease,
 Those that their *Liues* to vertue *heere* doe frame,
 Are in the *World*, but yet not of the same.
 Some such there are, whom neither *Flesh* nor *Diuell*
 Can wilfully drawe on to any euill:
 But for the *World*, as 't is the *World*, you see
 It *runnes on Wheelles*, and who the *Palfreys* bee.
 Which *Embleme* to the *Reader* doth display
 The *Diuell* and the *Flesh* *runnes* swift away.
 The *Chayn'd* ensnared *World* doth follow fast,
 Till All into *Perdition's* pit be cast.
 The *Picture* topsie-turvie stands *kewwaw*:
 The *World* turn'd vpside downe, as all men know."

Taylor's pamphlet is really an invective against coaches, which he stigmatizes as "upstart four-wheeled tortoises," far beneath the cart in dignity and usefulness. This he endeavors to show after the following manner: "As *Man* is the most noblest of all Creatures, and all four-footed *Beasts* are ordayned for his vse and seruice; so a *Cart* is the Embleme of a *Man*, and a *Coach* is the Figure of a *Beast*; for as man hath two legges, a *Cart* hath two wheeles; the *Coach* being (in the like sense) the true resemblance of a *Beast*, by which is Parabolically demonstrated vnto vs, that as much as *Men* are superior to *Beasts*, so much are honest and needful *Carts* more nobly to be regarded and esteemed aboue needlesse, vpstart, fantasticall, and Time-troubling *Coaches*.

"And as necessities and things, whose commodious vses cannot be wanted [dispensed with], are to be respected before Toyes and trifles (whose beginning is Folly, continuance Pride, and whose end is Ruine); I say as necessity is to be preferred before superfluity, so is the *Cart* before the *Coach*; For *Stones*, *Timber*, *Corne*, *Wine*, *Beere*, or any-thing that wants life, there is a necessity they should be carried,

because they are dead things and cannot goe on foot, which necessity the honest *Cart* doth supply. But the *Coach*, like a superfluous Bable [hauble?] or an uncharitable Mizer, doth sildome or neuer carry or help any dead or helplesse thing; but on the contrary, it helps those that can help themselues (like *Scoggin* when he greazed the fat *Sow* on the Butt-end), and carries men and women, who are able to goe or run, *Ergo*, the *Cart* is necessary, and the *Coach* superfluous.

"Besides, I am uerily perswaded that the proudest Coxcombe that euer was iolted in a *Coach* will not be so impudent, but will confesse that humility is to be preferred before pride; which being granted, note the affability and lowlines of the *Cart*, and the pride and insolency of the *Coach*; For the *Carman* humbly paces it on foot, as his *Beast* doth, whilst the *Coachman* is mounted (his fellow-horses and himself being all in a livery) with as many uarieties of Laces, faecings, Cloath and Colours as are in the *Rainebowe*, like a Motion or Pageant rides in state, and loades the poore *Beast*, which the *Carman* doth not, and if the *Carman's* horse be melancholly or dull with hard and heavy labour, then will he like a kinde Piper whistle him a fit of mirth to any tune from aboue *Eela* to below *Ganmoth*, of which generositie and courtesie your *Coachman* is altogether ignorant, for he neuer whistles, but all his musicke is to rappe out an oath or blurt out a curse against his *Teeme*.

"The word *Carmen* (as I finde it in the *Dictionarie*) doth signifie a Verse or a Song, and betwixt *Carmen* and *Carmen* there is some good correspondencie, for Versing, Singing, and Whistling are all three Musicall, besides the *Carthorse* is a more learned beast then the *Coachhorse*, for scarce any *Coachhorse* in the world doth know any letter in the Booke, when as euery *Carthorse* doth know the letter G, uery vnderstandingly.

"If Adultery or Fornication bee committed in a *Coach*, it may be grauely and discreetly punished in a *Cart*, for as by this meanes the *Coach* may be a running Bawdry-house of abhominacion, so the *Cart* may (and often is) the sober, modest, and ciuill pac'd Instrument of Reformation; so, as the *Coach* may be vice's infection, the *Cart* often is vice's correction."

After enumerating the great usefulness of the cart in England under Danish rule, Taylor entreats the reader with holy horror to "beware

of a *Coach* as you would doe of a *Tyger*, a *Wolfe*, or a *Leuiathan* : Ple assure you it eates more (though it drinkes lesse) then the *Coachman* and his whole *Teeme* ; it hath a mouth gaping on each side like a monster with which they haue swallowed all the good housekeeping in *England* : It lately (like a most insatiable deuouring Beast) did eate vp a *Knight*, a neighbour of mine in the Country of *N.*, a *Wood* of about 400 *Akers*, as if it had been a bunch of *Radish* ; of another it deuoured a whole *Castle*, as it had been a *Marchpane*, scarcely allowing the *Knight* and his *Lady* halfe a colde shoulder of *Mutton* to their suppers on a *Thursday* night ; out of which reuersion the *Coachman* and the *Footeman* could picke but hungry *Vailes* ; in another place (passing through a *Parke*) it could not be content to eate up all the *Deere* and other grazing *Cattell*, but it bit up all the *Oakes* that stood bareheaded, there to do homage to their *Lord* and *Maister* euer since the conquest, crushing their olde sides as easily as one of our fine *Dames* (with a poysoned breath) will snap a *cinamon-stick* ; or with as much facillity as a *Bawde* will eate a *Pippin Tart*, or swallow a stewed *Pruine*.

“ For (what call you the *Towne*) where the great *Oysters* come from? There it hath eaten vp a *Church*, *Chauncell*, *Steeple*, *Bells* and all, and it threatens a great *Common* that lyes neere, which in *diebus illis* [in other days] hath relieued thousands of poore people ; nay, so hungry it is, that it will scarcely endure, in a *Gentleman's* house, a poore neighbour's childe so much as to turne a *Spit* ; nor a *Yeoman's* sonne to enter the house, though but in good will to the *Chambermaide*, who anciently from 16 to 36 was wont to haue his breeding either in the *Buttry*, or *Cellar*, *Stable*, or *Larder*, and to bid good-man *Hobs*, good-wife *Grub*, or the youth of the parish welcome at a *Christmasse* time ; but those daies are gone, and their fellowes are neuer like to bee seene about any of our top-gallant houses. There was a *Knight* (an acquaintance of mine) whose whole meanes in the world was but threescore pounds a yeere, and about 20 of the same went for his *Wiue's Coach-hire* ; now (perhaps) you shall haue an *Irish Footman* with a *Jacket* cudgell'd downe the shoulders and skirts with yellow or Orange tawny *Lace*, may trot from *London* 3 or 4 score miles to one of these decayed *Mansions*, when the simpring, scornfull *Puffe*, the supposed *Mistresse* of the house (with a mischief) who is (indeed) a kinde of creature retired for a while into the *Countrey* to escape the

whip in the Citie; she demaunds out of the window scarce ready, and dressing herself in a glasse at noone; Fellow what is thine Errand, hast thou letters to me? And if it be about dinner, a man may sooner blow vp the gates of *Bergen ap Zome* with a Charme then get entrance within the bounds of their Barr'd, Bolted, and Barracadoed Wicket: About two a Clocke, it may bee after walking an houre or twaine, Sir *Sellall* comes downe, vntrust with a Pipe of *Tobacco* in his fist to knowe your businesse, having first peeped thorow a broken pane of Glasse, to see whether you come to demand any money, or olde debt, or not, when after a few hollow dry compliments (without drinke) he turns you out at the gate, his worshippe returning to his Stoue. What Townes are layde waste? What fields lye vntilled? What goodly houses are turn'd to the habitations of *Howlets*, *Dawes*, and *Hobgoblins*? What numbers of poore are encreased? yea examine this last yeere but the Register bookes of burials, of our greatest Townes and Parishes of the land, as *Winondham* in *Norfolke*, *White Chappell* neere *London*, and many other, and see how many haue benee buried weckely, that haue meerey perished for want of bread; whilst Pride and Luxurie dam vp our streetes, Barracado our highwaies, and are ready euen to drive ouer their Graues, whom their vnnereiful Pride hath farnished.

"Whence come Leather to be so deare, but by reason (or as I should say against reason) of the multitude of Coaches and Carroches, who consume and take vp the best Hides that can be gotten in our Kingdome, insomuch that I cannot buy a payre of Bootes for myself vnder an Angell, nor my Wife a payre of Shooes (though her foote be vnder the seauenteenes) vnder eight groates or three shillings, by which meanes many honest Shoemakers are either vndone or vndoing, and infinite numbers of poore Christians are enforced to goe barefooted in the colde Winters, till with very benumbednesse some their toes and some their feete are rotred off, to the numberlesse increases of crooked Cripples and wooden legg'd beggers, of which sort of miserable dismembred wretches every streete is plentifully stored with, to the scorn of other Nations, and the shame and obloquy of our owne.

"The Saddlers (being an ancient, a worthy, and a vsefull Company) they haue almost ouerthrowne the whole Trade, to the vndoing of many honest families; For whereas within our memories, our Nobility and Gentry would ride well mounted (and sometimes walke on foote)

gallantly attended with three or foure score braue fellowes in blew coates, which was a glory to our Nation, and gaue more content to the beholders, then forty of your Leather Tumbrels. Then men preseru'd their bodies strong and able by walking, riding, and other manly exercises: Then Saddlers were a good Trade, and the name of a Coach was Heathen-Greeke. Who euer saw (but vpon extraordinary occasions) Sir *Philip Sidney*, Sir *Francis Drake*, Sir *Iohn Norris*, Sir *William Winter*, Sir *Roger Williams*, or (whom I should haue nam'd first) the famous Lord *Gray*, and *Willoughby*, with the renowned *George Earle of Cumberland*, or *Robert Earle of Essex*: These sonnes of *Mars*, who in their times were the glorious Brooches of our Nation, and admirable terrour to our Enemies: these I say did make small vses of *Coaches*, and there were two mayne reasons for it, the one was that there were but few *Coaches* in most of their times; and the second reason is, they were deadly foes to all Sloath and effeminacie: The like was Sir *Francis Vere*, with thousands others; but what should I talke further? this is the rattling, rowling, rumbling age, and *The World runnes on Wheeles*. The Hackney-men who were wont to haue furnished Trauellers in all places with fitting and seruiceable horses for any journey (by the multitude of *Coaches*) are vndone by the dozens, and the whole Common-wealth most abominably iaded, that in many places a man had as good to ride vpon a wooden post, as to poast it vpon one of those hunger-staru'd hirelings: which enormity can be imputed to nothing but the *Coaches'* intrusion, is the Hackney-man's confusion.

"Nor haue we poore Water-men the least cause to complaine against this infernall swarme of Trade-spillers, who like the *Grasshoppers* or *Caterpillars* of *Egipt* haue so ouer-runne the land, that we can get no living vpon the water; for I dare truely affirme that euery day in any Tearme (especiallly if the Court be at *Whitehall*) they do rob vs of our linings, and carry 560 fares daily from vs, which numbers of passengers were wont to supply our necessities, and enable vs sufficiently with meanes to doe our Prince and Country seruice."

Some two pages are here omitted, as being unfit for publication in this age. Among other complaints, Taylor charges that the courtesans of London had transferred their patronage from the watermen to the hackney-coaches, by reason of which "the Coachman hath gotten all the custome from the Scullers' pay Mistris." The irate waterman

continnes : " A Wheelright or a maker of Carts, is an ancient, a profitable, and a Trade which by no meanes can be wanted ; yet so poore it is that scarce the best among them can hardly euer attaine to better then a calue skin sute, or a piece of necke beefe & carret-roots to dinner on a Sunday ; nor scarcely any of them is ever mounted to any Office about the degree of a Scauenger, or a Tything-man at the most. On the contrary, your Coach-makers trade is the most gainefullest about the Towne, they are apparelled in Sattens and Veluets, are Maister of their Parish, Vestry-men, who fare like the Emperors *Heliogabalus* or *Sardanapalus*, seldome without their Mackeroones, Parmisants, Jellies and Kickshawes with baked Swannes, Pasties hote or cold, red Deere Pyes, which they haue from their Debtors worships in the Countrey : neither are these Coaches only thus cumbersome by their Rumbling and Rutting, as they are by their standing still, and damming vp the streetes and lanes, as the *Blacke Friers*, and diuers other places can witnesse, and against Coach-makers dores the streetes are so pestered and clogg'd with them : that neither Man, Horse or Cart can passe for them : in so much as my Lord *Maïor* is highly to be commended for his care in this restraint, sending in February last many of them to the Counter for their carelesnesse herein.

"They [Coaches] haue beene the uniuersall decay of almost all the best Ash Trees in the Kingdome, for a young plant can no sooner peepe vp to any perfection, but presently it is felled for the Coach ; Nor a young Horse bred of any beauty or goodnesse but he is ordaind from his foaling for the seruice of the Coach ; so that whereas in former ages, both in peace and warres we might compare with any Nation in the world for the multitude and goodnesse of our Horses : wee now thinke of no other imployment for them, then to draw a Coach, and when they are either lamed by the negligence of the Coachman, or worne out after many yeares with trotting to Playes and Bawdy houses, then are they (like old maymed souldiers) after their wounds are scarres, preferred to Woodmongers (where they are well Billited) or to Draymen, where they turn Tapsters, and draw Beere by whole Barrels and Hogsheads at once ; and there they weare out the Remainder of their daies, till new harneis for others are made of their olde skinnes.

"The last Proclamations concerning the Retiring of the Gentry out of the Citty into their Countreyes, although my selfe, with many thou-

sands more were much impouerished and hindered of our Liuings by their departure : yet on the other side how it cleered the streetes of these way-stopping Whirligigges ! for a man now might walke without being *stand vp hoe*, by a fellowe that scarcely can either goe or stand himselfe. Prince, Nobilitie, and Gentlemen of worth, Offices and Quality, haue herein their Priuiledge, and are exempt, may ride as their occassions or pleasures shal inuite them, as most meete they should ; but when every *Gill Turnetripe*, Mistris *Fumkins*, Madame *Polecat*, and my Lady *Trash*, *Froth* the Tapster, *Bill* the Taylor, *Lauender* the Broker, *Whiffe* the Tobacco-seller, with their companion 'Trugs, must be Coach'd to *S. Albanes*, *Burntwood*, *Hockley* in the *Hole*, *Croydon*, *Windsor*, *Vxbridge*, & many other places, like wilde Haggards prancing vp and downe, that what they get by cheating, swearing and lying at home, they spend in Ryot, Whoring and Drunkenesse abroad. I say by my hallidome, it is a burning shame ; I did lately write a pamphlet called a *Thiefe*¹ wherein I did a little touch upon this point : that seeing the Heard of Hireling Coaches are more than the Whirries on the Thames, and that they make Leather so excessive deere, that it were good the order in *Bohemia* were observed heare, which is, that every hired Coach should be drawn with Ropes, and that all their Harnesse should be Hemp and Cordage : Besides if the Coner [top] and Bootes of them were of good Rosind or pitched Canvis it would bringe downe the price of Leather, and by that meanes a hired Coach would be knowne from a Princes, a Nobleman, Ladies, or people of note, account, respect and quality.

" And if it be considred in the right *Kue*, a Coach or Carroach are meere Engines of Pride, (which no man can denie to be one of the seuen deadly sinnes) for two Leash of Oyster wiues hired a Coach on a Thursday after Whitsontide, to carry them to the Greene Goose Faire at *Stratford* the *Bowe*, and as they were hurried betwixt *Algate* and *Myle-end*, they were so be-Madam'd, be-Mistris, and Ladifide by the Beggars, that the foolish women began to swell with a proud supposition or Imaginary greatnesse, and gaue all their money to the mendicating Canters, insomuch they were feigne to pawne their Gownes and Smocks the next day to buy Oysters, or else their pride had made them Cry for want of what to cry withall.

¹ See the note on page 248.

“Thus much I can speake by experience: I doe partly know some of mine own qualities and I doe knowe that I doe hate pride, as I hate famine or surfetting: and moreouer, I know my selfe to be (at the best) but *John Taylor*, and a mechanicall Waterman, yet it was but my chance once to bee brought from *Whitehall* to the Tower in my Maister Sir William *Waade's* Coach, and before I had bene drawne twenty yards, such a Timpany of pride puffed mee vp, that I was ready to burst with the winde Chollicke of vaine glory. In what state I would leane ouer the Boote and look and pry if I saw any of my acquaintance, and then I would stand vp, vaying my Bonnet, kissing my right clawe, extending my armes as I had bene swimming, with God saue your Lordship, Worship, or how doest thou honest neighbor or good-fellow? In a word the Coach made mee thinke my selfe better than my betters that went on foote, and that I was little inferiour to *Tamberlaine*, being iolted thus in state by those pampered Iades of *Belgia*: all men of indifferent [unprejudiced?] judgement will confesse, that a Cart is an instrument conformable to law, order and discipline; for it rests on the Sabboath dayes, and commonly all Holy dayes, and if it should by any meanes break or transgresse against any of these good Iniunctions, there are Informers that lye in ambush (like carefull Scowtes) to informe against the poore *Cart*, that in conclusion my Lady *Pecunia* must become surety and take vp the matter, or else there will be more stirre about the flesh than the Broath is worth: whereas (on the contrary) a *Coach* like a *Pagan*, an *Heathen*, an *Infidel*, or *Atheist*, obserues neither Saboath or holiday, time or season, robustiously breaking through the toyle or net of deuine and humane law, order and authority, and as it were contemning all Christian conformity: like a dogge that lyes on a heape of Hay, who will eate none of it himselfe, nor suffer any other beast to eate any: euen so the Coach is not capable of hearing what a Preacher saith, nor will it suffer men or women to heare that would heare, for it makes such a hideous rumbling in the streetes by many Church doores, that peoples eares are stop'd with the noyse, whereby they are debard of their edifying, which makes faith so fruitlesse, good workes so barren, and charity as cold at Midsommer, as if it were a great Frost, and by this meanes souls are rob'd and starued of their heauenly Mamma, and the Kingdome of darknesse replenished: to auoyd which they have set vp a crosse post in *Cheapside* on Sundayes neere Woodstreet end which

make the Coaches rattle and jumble on th' other side of the way, further frō the Church, and from hindring of their hearing. . . .

"The Cart is an open transparant Engine, that any man may perceiue the plaine honesty of it; there is no part of it within or without, but it is in the continuall view of all men: On the contrary, the *Coach* is a close hypocrite, for it hath a couer to any Knauery, and Curtaines to vaile or shadow any wickednesse: besides like a perpetuall Cheater, it weares two Bootes and no spures, sometimes having two paire of legges in one Boote, and often times (against nature) most preposterously it makes faire Ladies wear the Boote; and if you note, they are carried backe to backe, like people surpriz'd by Pyrats, to be tyed in that miserable manner and throwne ouer boord into the sea. Moreouer it makes people imitate sea Crabs, in being drawne sideways, as they are when they sit in the Boote of the Coach, and it is a dangerous kinde of carriage for the Commonwealth, if it be rightly considered: for when a man shall be a Iustice of the Peace, a Sericant, or a Councillor at Law; what hope is it that all or many of them should vse vpright dealing, that haue been so often in their youth and daily in their maturer or riper age drawne aside continually in a *Coach*, some to the right hand, and some to the left? for vse makes perfectnesse and often going aside willingly makes men forget to goe vpright naturally.

"The order of Knighthood is booth of great Antiquity and very honorable, yet within these later times there is a strange mysterie crept into it, for I haue noted it, that when a Gentleman hath the sword laid upon his shoulder, either by his Prince, or his Deputy, or Generall in the field, although the blow with the sword be an honour to the man, yet (by a kinde of inspiration) it cripples his wife, though shee be at that time 300 miles from her husband, for if you but note her, you shall see her lamed foreuer, so that shee can by no meanes goe without leading vnder the arme, or else shee must be carried in a Coach all her life time after; forgetting in a manner to goe to her feete so much as to *Church*, though it be but two Quoytes cast: for I haue heard of a Gentlewoman that was lamed in this manner, who sent her man to [from] Smithfield to Charring-Crosse, to hyre a Coach to carry her to Whitehall: another did the like from Ludgate-hill, to be carried to see a Play at the Blacke-Friers:¹ and in former times when

¹ Any one familiar with these localities will readily perceive that the old waterman

they vsed to walke on foote, and recreate themselues, they were both strong and healthfull; now all their exercise is priuately to sawe Billets, to hang in a Swinge, or to rowle the great Rowler in the Alleies of their Garden, but to goe without leading, or Riding in a Coach is such an impeachment and derogation to their Calling, which flesh and bloud can by no meanes endure.

“Euery man knowes, that were it not for the *Cart* the Hay would Rot in the medowes, the Corne perish in the field, the markets be emtily furnished; at the Courts remoue the King would bee vnserued any many a Gallant would be enforced to bee his owne Sumpter-horse to carrie his luggage, bag and baggage himselfe: and finally, were it not for the mannerly and courteous seruice of the *Cart*, many a well deseruing ill condition’d braue fellow might goe on foote to the Galloves.

“A *Cart* (by the judgment of an honorable and graue Lawyer) is elder brother to a *Coach* for Antiquity: and for vtility and profit, all the world knowes which is which; yet so vnaturall and so vnmannerly a brother the *Coach* is, that it will giue no way to the *Cart*, but with pride, contempt, bitter curses and execrations, the Coachman wishes all the Carts on fire, or at the diuell, and that Carmen were all hang’d when they cannot passe at their pleasures, quite forgetting themselues to bee sawey vnprofitable intruders, vpstarts and Inuocators.”

Next comes an immodest paragraph we must pass by; then we are told, “What excessiue waste do they make of our best broadcloath of all colours? and many times a young heire will put his old Fathers old Coach in a mourning Gowne of Cloth or Cotton, when many of the poore distressed members of Christ, goe naked, staruing with cold, not having any thing to hide their wretched carkasses; and what spoyle of our Veluets, Damaskes, Taffataes, Siluer and Gold Lace, with Fringes of all sorts, and how much consumed in gilding, wherein is spent no small quantity of our best and finest gold, nor is the charge little of maintaining a *Coach* in reparation; for the very mending of the Harnesse, a Knights Coachman brought in a bill to his Master of 25. pounds: besides, there is vsed more care and diligence in matching the Horses and Mares, then any fathers and mothers doe in the marriage of their sonnes and daughters: for many times a rich lubberly

meant to show that in both cases these women sent their servants *long* distances for coaches to carry them only a *short* journey.

Clowne, the sonne of some gowty extortioner, or rent-racking Rascall, (for his accursed muckes sake) may bee matched with a beautiful or proper well qualified and nobly descended Gentlewoman, and a well-fac'd handsome Esquire or Knights sonne and heire may be ioin'd with a Ioiners puppet, or the daughter of a Sexton: but for the choyce of your Coach-horses there is another manner of prouidence to bee vsed, for they must be all of a colour, longitude, latitude, Cresitude, height, length, thieknesse, breadth, (I muse they do not weigh them in a paire of Ballance) and beeing once matched with a great deale of care and cost, if one of them chance to dye (as by experience I know a Horse to bee a mortall beast) then is the *Coach* like a maymed cripple, not able to trauel, till after much diligent search a meete mate be found whose correspondency may be as equiaalent to the suruiuing Palfrey, and in all respects as like as a Broome to a Beesome, Barne or Yeast, or Quodlings to boyld Apples.

"The mischiefes that haue bin done by them are not to be numbred; as breaking of legges and armes, ouerthrowing downe hills, ouer bridges, running ouer children, lame and old people, as *Henrie* the Fourth of *France*, (the father to the King that now raigneth) he and his Queene were once like to haue beene drowned, the *Coach* ouerthrowing besides a bridge, and to proue that a *Coach* owed him an vnfortunate tricke, hee was some few yeeres after his first escape, most inhumanely and traitrously murdred in one, by *Rauiliacke* in the streets at *Paris*: but what need I runne my inuention out of breath into foraigne countreys for examples, when many of the chiefe Nobilitie and Gentry of our owne Natione have some triall and sad experience of the truth of what I write? sometimes the Coachman (it may be hath bin drunke, or to speake more mannerly stolne a Manchet out of the Brewers Basket) hath tumbled besides his Boxe of State, and the *Coach* running ouer him hath kild him, the whilst the horses (hauing the reines loose) haue runne away with their Rattle at their heeles (like dogges that had bladders of dried Beanes, or empty bottles at their tails) as if the deuill had beene in them, and sometimes in the full speede of their course a wheele breakes, or the Nane slips off from the Axletree, downe leapes the Coachman, and away runnes the horses, throwing their carriage into bushes, hedges, and ditches, neuer leaving their mad pace till they haue torne to tatters their tumbling Tumbrell, to the manifest perill, danger, and vnreouerable hurt to those whom

they carry, and to all men, women, children, and cattell, as Hoggess, Sheepe, or whatsoever chanceth to bee in their way: besides the great cost and charge of mending Reparations of the *Coach*.

"There is almost nothing, but when it is worne out, it will serue for some vse, either for profit or pleasure (except a *Coach*;) of the bottome of an old *Cart*, one may make a fence to stop a gap, of the Raues one may make a Ladder for Hennes to goe to Roost, of an olde Bores Franke, a new Dogge-kennell may be founded; of a decayed Whirry or Boat, a backe-part of a house of office may be framed (as you may see eury where on the Banke-side;) of an olde Barrell, a bolting Hutch, an ouer . . . I knew a neighbour of mine (an olde Iustice) that of the bald veluet lyning of his Cloake, made him a paire of new Breeches, and those Breeches being worne past the best, with the best of them, he made his wife a new French Hoode, and when that was bare, and past her wearing, it made him facing for his new Boote-tops: but an old *Coach* is good for nothing but to cousen and deceiue people, as of the olde rotten Leather they make Vampires for high Shooes, for honest Country Plow-men, or Belts for Souldiers, or inner lynings for Girdles, Dogges-chollers for Mastiffes, indecde, the Boxe if it were bored thorow, would bee fittest for a close stoole, and the body would (perhaps) serue for a Sow to pigge in.

"If the curses of people that are wrong'd by them might haue preuailed, sure I thinke the most part of them had beene at the deuill many yeeres agoe. Butchers cannot passe with their cattel for them: Market folkes which bring prouision of victualls to the Citie, are stop'd, stay'd and hindred. Carts or Waynes with their necessary lading are debard and letted, the Milke-maydes ware is often spilt in the dirt, and peoples guts like to be crushed out being crowded and shrowded vp against stalls, and stoopes, whilst Mistris *Siluerpin* with her Pander, and a paire of cram'd Pullets, ride grinning and deriding in their *Hel-cart*,¹ at their miseries who go on foote. I myselfe have been so serued, when I haue wished them all in the great Breach, or on a lighte fire on *Hownslow-Heath*, or *Salisbury Plaine*; and their damming vp the streetes in this manner, where people are wedged together that they can hardly stirre is a maine and great aduantage to

¹ Evelyn, in his *Character of England*, published in 1659, informs us that Londoners still called coaches *helcarts*, the name given them by John Taylor twenty years before.

the most virtuous Myserie of purse-cutting, and for anythinge I knowe the hyred or Hackney-Coachman may ioyne in confederacy and share with the Cutpurse, one to stop vp the way, and the other to shift in the crowd.

“The superflous vse of *Coaches* hath been the occasions of many vile and odious crimes, as murther, theft, cheating, hangings, whippings, Pillories, stockes and cages; for house-keeping neuer decayed till *Coaches* came into England, till which time those were accounted the best men who had most followers and retainers; then land about or neere London was thought deare enough at a noble the Aker yeerely, and a ten-pound house-rent now, was scarce twenty-shillings then: but the witchcraft of the *Coach* quickly mounted the price of all things (except poore mens labour) and withall transformed in some places 10, 20, 30, 40, 50, 60, or 100 proper seruingmen, into two or three Animals (*videlicet*) a Butterfly page, a trotting footeman, a stiffe-drinking Coachman, a Cooke, a Clarke; a Steward, and a Butler, which hath enforced many a discarded tall fellow (through want of meanes to liue, and grace to guide him in his pouertie) to fall into such mischienous actions before named, for which I thinke the Gallowses in England haue deuoured as many lusty valiant men within these 30 or 40 yeeres, as would haue beene a sufficient armie to beate the foes of Christ out of Christendome, and marching to *Constantinople*, haue pluck'd the great Turke by the Beard: but as is afore said, this is the age wherein *The World Runnes on Wheelles*.

“It is a most vneacie kinde of passage in *Coaches* on the paved streetes in London, wherein men and women are so tost, tumbled, iumbled, rumbled, and crossing of kennels, dunghils, and vneuen-ways, which is enough to put all the guts in their bellies out of joynt, to make them haue the Palsey or Megrum, or to cast their Gorges with continuell rocking and wallowing: to preuent which, there was a Gentleman of great note, found fault with his *Coach*-horses, because his coach iolted him, commanding his man to sell away those hard trotting Iades, and to buy him a paire of Amblers, that might drawe him with more ease: another when hee saw one of his horses more lusty and free than his fellow, he commanded his *Coach*-man to feede him only with Hay and water, till hee were as tame and quiet as the other, which wise command was dutifully obserued.

“The best vse that was euer made of *Coaches* was in the olde warres

betwixt the *Hungarians* and the *Turkes*, (for like so many land Gallies) they carried Soldiers on each side with Crossbowes, and other warrelike engins, and they serued for good vse being many thousands of them, to disrowte their enemies, breaking their rankes and order, making free and open passage for their horse and foote amongst the scattered squadrons and regiments, and vpon occasion they serued as a wall to Embarricado and fortifie their campe: this was a millitarie employment for *Coaches*, and in this sorte onely I could wish all our hyrelings to be vsed. It is to be supposed that *Pharaohs* charriots which were drowned in the Red sea, were no other things in shape and fashion, then our *Coaches* are at this time, and what great pittty was it, that the makers and memories of them had not beene obliuiously swallowed in that *Egyptian* downfall?"

In the twenty-second year of the reign of James I (1625), twenty hackney-coaches¹ were set up in London, and stood ready at the inns for hire when wanted, although, as we have seen from Taylor's work, they were to be had elsewhere much earlier. In the time of Charles I, ten years later, there was a law passed forbidding the "general and promiscuous use of them in London and Westminster, or the suburbs, they being not only a great disturbance to His Majesty, his dearest consort the Queen, the nobility, and others of place and degree, in their passage through the streets; but the streets themselves are so pestered, and the pavement broken up, that the common passage is hereby hindered, and the prices of hay and corn exceedingly dear. Therefore it is recommended and forbidden that no hired coaches should be used in London, etc., except they be to travel three miles out of the same; and also that no persons shall go in a coach, in the said streets, except the owners of the coach shall constantly keep up favorable horses for our service when required." This proclamation alluded

¹ The term "hackney," which formerly was applied to a horse let for hire, is by some supposed to be derived from the Welsh and Teutonic word *hacknai*; but the first coaches that ran for the conveyance of casual passengers started from Hackney, carrying their fares to London. From this circumstance undoubtedly they came to be called "hackney-coaches." As we have elsewhere shown (p. 220), they were not introduced into Paris, under the name of "fiacres," until 1650, twenty-five years later. Some years afterward (1784), when umbrellas were introduced from Paris by one John Jameson, there was great opposition shown to their use by the chairmen and hackney-men of London, under the impression that they were detrimental to business, -- such is the selfishness of man.

to such public coaches as had then recently been established by private persons, who had contracted to carry passengers from one town to another, without springs, and were so designated. But it is said that these coaches moved with much caution and great solemnity, the horses seldom if ever being allowed to indulge in a trot.

An individual who had engaged in the livery business about this time is thus noticed in a letter from Garrard to Strafford: "I cannot omit to mention any new thing that comes up amongst us, though ever so trivial. There is one Captain Bailey, he hath been a sea-captain, but now lives on land, about this city, where he tries experiments. He hath erected, according to his ability, some four hackney-coaches, put his men in livery, and appointed them to stand at the May-pole in the Strand, giving them instructions at what rates to carry men into several parts of the town, where all day long they may be had. Other hackney-men seeing this way they flocked to the same place, and perform their journeys at the same rate, so that sometimes there is twenty of them together, which disperse up and down, so that they and others are to be had everywhere, as watermen are to be had by the water-side. Everybody is much pleased with it; for whereas before coaches could be had but at great rates, now a man may have one much cheaper." Indeed, we find in Massinger's "City Madam," that no lady stirred without her coach; and even when she went to church, it was not for devotion, but to show her pomp.

In a small volume, the first edition of which was published in 1631, under the title of "Orbis Sensualium Pictus,"¹ mention is made of the following vehicles as then in use: first, the hanging-wagon, or coach (*currus pensilis*), drawn by six horses, and used by great persons; second, the chariot, drawn by two horses. The same author speaks of horse-litters (*arcere lecticæ*).

This same year the inhabitants of Blackfriars were so much annoyed that they petitioned the Privy Council against the number of coaches bringing auditors to the theaters there. In the general clamor for their suppression, both prose-writers and poets joined their energies

¹ This was originally written in Latin, designed for the instruction of young persons. A copy of the work in English, "adorned with many wood-cuts," may be found in the British Museum. The full title is, "*Orbis Sensualium Pictus*, by Joh. Amos Commenii, Englished by Charles Hoole. London, printed for J. Kirton, at the Kings-Arms, in Saint Pauls Churchyard, 1658."

“to with the Hackney-coaches downe.” So popular was the outcry that two ballads were written and published at the time, and found a ready sale.¹ They were sung to the tune of “Old King Harry,” and read thus : —

“ As I passed bye, this other day,
 where sack and claret spring,
 I heard a mad crew by the way,
 that loud did laugh and sing :
 Heigh downe, dery, dery downe,
 with the hackney-coaches downe !
 They cried aloud ;
 They made such a crowde,
 Men cannot passe the towne.

“ The boyes that brew strong ale, and care
 not how the world doth swing,
 So bonny, blithe, and joviall are,
 their lives are drink and sing :
 Heigh downe, dery, dery downe,
 with the hackney-coaches downe !
 To make them roome,
 They may freely come —
 And liquor the thirsty towne.

“ The collier, he 's a sack of mirth,
 and though as black as soote,
 Yet still he tunes and whistles forth,
 and this is all the note :
 Heigh downe, dery, dery downe,
 with the hackney-coaches downe !
 They long made fooles
 Of poor carry-coales,
 But now must leave the towne.

¹ Copies of the originals are preserved in a portly volume among other songs of the time, in the British Museum, lettered “*Roxburge Ballads.*” The two occupy pages 546 and 547, headed, “*The Coaches Ouerthrow, or A joviall Ecaltation of Divers Tradesmen, and others, for the Suppression of troublesome Hackney Coaches.*” London, printed by Francis Grove, but without a date. The “broadside” is printed as two songs; the first comprises the seven, and the second the nine last verses, which we give as one song. The first portion has at the top a rude cut of a coach turned bottom upwards, drawn by two horses at the pole, a third horse leading, riding which are hostlers in livery, a coachman being mounted as driver on a rude-looking dicky-seat. Two runners on either side are placed opposite the hind wheels. The second has an engraving of a coarsely designed horse and cart, accompanied by a sedan, borne by two men. Chambers's *Book of Days* ascribes the authorship to John Taylor, which is extremely doubt-

- “The carriers of every shire
are, as from cares immune ;
So joviall is this packe-horse quire,
and this is all their tune :
Heigh downe, dery, dery downe,
with the hackney-coaches downe !
Farewell, adew,
To the jumping crew,
For they must leave the towne.
- “Although a carman had a cold,
he strained his March-bird voice,
And with the best a part did hold,
to sing and to rejoyce :
Heigh downe, dery, dery downe,
with the hackney-coaches downe !
The carman’s cars,
And the merchants wares,
May passe along the towne.
- “The very slugs did pipe for joy,
that coachmen hence should hye ;
And that the coaches must away —
a mellowing up to lye :
Heigh downe, dery, dery downe !
with the hackney-coaches downe !
Passe they their scope,
As round as a rope, —
Wee ’l jogge them forth of the towne.
- “Promoters, and the informers,
that oft offences hatch ;
In all our times the money-wormes,
and they are for to catch :
Heigh downe, dery, dery downe,
with the hackney-coaches downe !
For their restraints
Will, with complaints,
Fill all [the noisy towne].¹
- “The world no more shall run on wheelles,
with coach-men, as ’t has done ;

ful, as it is not found in *All his Works*, published in 1630; nor was he mentally equal to the task of its composition.

¹ The words in brackets, having been omitted in the copy, have been supplied by Mr. Collier, from conjecture, who remarks that “obvious misprints occur, which it is not worth while to point out.” With this verse the first part of the song ends.

But they must take them to their heeles,
 and try how they can run :
 Heigh downe, dery, dery downe,
 with the hackney-coaches downe !
 We thought they 'd burst
 Their pride, since first
 Swell'd so within the towne.

“ The sedan does (like Atlas) hope
 to carry heaven pick-pack ;
 And likewise, since he has such scope
 to beare the towne at 's back :
 Heigh downe, dery, dery downe,
 with the hackney-coachmen downe !
 Arise, Sedan,
 Thou shalt be the man,
 To beare us about the towne.

“ I love sedans, cause they do plod
 and amble every where ;
 Which prancers are with leather shod,
 and ne'er disturbe the eare :
 Heigh downe, dery, dery downe,
 with the hackney-coaches downe !
 Their jumpings make
 The pavement shake ;
 Their noyse doth mad the towne.

“ The elder brother shall take place —
 the youngest brother rise :
 The middle brother's out of grace —
 and every tradesman cryes :
 Heigh downe, dery, dery downe,
 with the hackney-coaches downe !
 'T would save much hurt,
 Spare dust and durt,
 Were they cleane out of towne.

“ The sick, the weake, the lame also,
 a coach, for ease, might beg ;
 When they on foote might lightly goe,
 that are as at right's leg :
 Heigh downe, dery, dery downe,
 with the hackney-coaches downe !
 Let's foote it out,
 Ere the yeare come about —
 'T will save us many a crowne.

“ What though we trip on boots and shoes,
 ’t will ease the price of leather ;
 We shall get twice what once we loose,
 when they do fall together :
 Heigh downe, dery, dery downe,
 with the hackney-coaches downe !
 Though one trade fall
 Yet in generall,
 ’T is a good to all the towne.

“ ’T is an undoing unto none,
 that a profession use ;
 Tis good for all — not hurt to one —
 considering the abuse :
 Then heigh downe, dery, dery downe,
 with the hackney-coaches downe !
 Then ’t is so decreed,
 By a royall deed
 To make it a happy towne.

“ Coach-makers may use many trades,
 and yet enough of meanes ;
 And coachmen may turne off their jades
 and helpe to draine the fens ;
 Heigh downe, dery, dery downe,
 with the hackney-coaches downe !
 The scythe and flail
 Cart and plow-taile
 Doe want them out of towne.

“ But to conlude, ’t is true I heare,
 they ’l soon be out of fashion ;
 ’T is thought they very likely are
 to have a long vacation :
 Heigh downe, dery, dery downe,
 with the hackney-coaches downe !
 Their terme ’s neare done,
 And shall be begun,
 No more in London towne.”

There were about one hundred of these hackney-coaches in London in 1634, “base, lean jades, unworthy to be seen in so brave a city, or to stand about a King’s court.”¹ A proclamation was at this time issued by the city government having in view the better regulation

¹ *Stafford's Letters*, Vol. I, p. 266.

of the hackney-coaches, the number causing inconvenience to commerce.

The following year (1635) sedans were introduced by Sir Saunders Dunscombe, under a license from Charles I, for the term of fourteen years. These soon became popular in London, although, judging from the engravings which have come down to us, they were rather cumbersome, and with the fare a heavy burden to the bearers. Sir Saunders, in introducing these sedans, declares his intention to be to "interfere with the too-frequent use of coaches, to the hindrance of the carts and carriages employed in the necessary provision of the city and suburbs of London."

The rivalry started by the introduction of sedans, "to interfere with the too-frequent use of coaches," probably gave rise soon after to the publication of a very humorous tract, entitled "Coach and Sedan: a pleasant Dispute for Precedence, the Brewer's Cart being Moderator." ¹ The *parties* to this dispute are thus described: "The one (Sedan) was

in a suite of green, after a strange manner, windowed behind and before with isinglasse (tale),² having two handsome fellows in green coats attending him; the one ever came before, the other came behind. Their coats were lac'd downe the back with

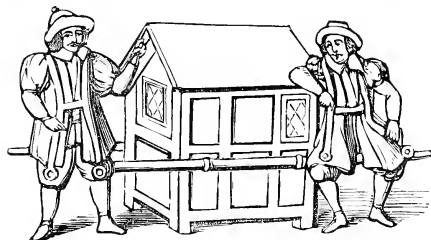

SEDAN OF 1635.

a greene-lace suitable; so were their half-sleeves, which perswaded me at first they were some east [off] suites of their masters. Their backs were harnessed with leather cingles cut out of a hide as broad as Dutch collops of bacon. The other (Coach) was a thick burly square-sett fellow, in a doublet of black leather, brasse button'd downe the brest, backe, sleeves and winges with monstrous wide bootes, fringed at the

¹ This pamphlet, *Coach and Sedan*, etc., was printed by Robert Raworth, for Jacob Crooch, London, 1636, and is now extremely scarce. The engravings on this and the following page are from copies which grace the head of the tract as originally published.

² In the first century the Romans were acquainted with shining glass (*talc*), as appears from a passage in Lactantius's *De Opificis Dei*, Cap. V; and is likewise inferred from a passage in Seneca's *Epist.* 90.

top with a net fringe and a round breech after the old fashion, gilded, and on his backside an achievement of sundry coats in their proper

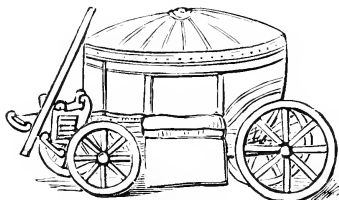

COACH OF 1635.

colors, &c., &c. Hee had only one man before him, wrapt in a red cloake, with wide sleeves, turned up at the hands, and cudgelled thicke on the back and shoulders with broad shining lace (not much unlike that which mummers make of strawen hatts); and on each side of him went a lacquay,

the one a French boy, the other Irish, both sutable alike."

The author, by way of argument, makes Sedan say, "And Coach, twice or thrice a yeare you must needes take a boone [good] voyage to London with your ladie, under a cullor [jacket], to see new colour'd, gilded, or painted, covered, seated, shod, or the like; when her errand indeede is, as one saith well, speaking to such ladies as love to visit the cite,

‘To see what fashion most is in request —
How is this Countess, and that court ladie drest.’

"Hence it happens, Coach, that by your often ambling to London, Sir Thomas or Sir John, sinks (as in a quick-sand) by degrees, so deep into the merchant, mercer, or taylor's booke, that hee is up to the eares, ere hee be aware; neither can hee be well drawne out without a teame of vsurers, and a craftie scrivener to be the fore-horse, or the present sale of some land; so that wise men suppose this to be one maine and principall reason why within a coach journey of a day or two from the citie, so many faire inheritances as have been purchased by lord-maiors, alderman, merchants, and other rich citizens, have not continued in a name to the third — yea, scarce the second generation; when, go farre north or westward, you shall find many families and names of nobilitie and gentry to have continued their estates two and three hundred yeeres and more in a direct succession."

The "Beere-cart" Judge closes the trial by saying, "Coach and Sedan you bothe shall reverence, and ever give way to beere (or brewer's) cart, wheresoever you shall meete him, either in citie or countrie, as your auncient and elder brother." Upon this decision,

Adams remarks, that Beere-cart's charge makes him an apt disciple of the lawyer who gave the celebrated oyster decision in another case. Messrs. Coach and Sedan, being neither of them satisfied with the decision of "Judge Beere-cart," took exceptions to the *rulings*, and appealed to a higher court, where the case was again argued between a Londoner and a Parisian with much vehemence, when the question seems to have assumed another form, — the superiority of the respective cities each represented. The proceedings, extracted from Sir William Davenant's works, are as follows: "The song being ended [at Rutland House], a consort of instrumental music after the French composition being heard awhile, the curtains are suddenly opened, and in the rostras appear sitting a Parisian and a Londoner, in the livery robes of the two cities, who declare concerning the pre-eminence of Paris and London. The Frenchman introduced the disputation thus: 'You of this noble citie are yet to become more noble by your candour to the plea betweene mee a bourgeois of Paris, and my opponent of London; being concerned in honor to lend your attention as favourably to a stranger as to your native oratour; since 'tis the greatest signe of a narrow education to permit the borders of rivers or strands of seas to separate the generall consanguinity of mankind; though the unquiet nature of man (still hoping to shake off distant power, and the incapacity of any one to sway universal empire) hath made them bounds to divide government. But already I thinke it necessary to cease persuading you, who will ever deserve to be my judges, and therefore mean to apply myself in admonishing him who is pleased awhile to be my adversarie.'"

After advancing sharp and critical remarks not pertinent to the question in dispute, the orator goes back to "the days of wheelbarrows, before those greater engines, carts, were invented, or before an umbrella of tiles was contrived to intercept the sun's rays, or that the shambles were so empty that fresh aire was to be avoided, lest it should sharpen the appetite," he continues: "I have now left your houses; I am passing through your streets; but not in a coach, for they are uneasylie hung and so narrow that I took them for sedans upon wheels. Nor is it safe for a stranger to use them 'till the quarrel be decided, whether six of your nobles sitting together shall stop and give place to so many barrels of beere. Your citie is the only metropolis in Europe where there is a wonderful dignity belonging to

carts! Master Londoner, be not too hot against coaches; take advice from one that eats much sorrell with his brothe."¹

Although the speech of the Londoner is not recorded, yet we infer that he was in accord with the pamphleteers and song-writers of the day. Nor were these alone the complainants, for we are told that in 1639 "the citizen shopkeepers in London made bitter charges that they were ruined by the coaches." For, said they, "Formerly when ladies and gentlemen walked in the streets, there was a chance of obtaining customers to inspect and purchase commodities; but now they whisk past in their coaches before our apprentices have time to cry out, 'What d'ye lack?'" Those tradesmen who occupied shops on the more public thoroughfares, and were accustomed to let out their upper rooms to members of Parliament and gentlemen from the country, sometimes for enough to pay the rents, likewise complained that the noise of the coaches had driven this profitable class of lodgers to less frequented places, to their serious loss.

Amid all this clamor against coaches, Sir Christopher Van Berg was perfecting "an invencion whereby the smythe's bellows may be made to blow without putting to any hand, either to houlde or to draw them"; and "also invencions of a kinde of waggons, waynes, coaches, carts, litters, wheelbarrows, packsaddles, and side-saddles, better for ease, advantage and profit than hitherto have been vsed," besides other things, which stamp him as "the man for the times," when everybody was engaged in a crusade against the "Hcl-carts." Added to this the ladies seem to have, unconsciously we suppose, lent their influence in making these "trade-spoilers" popular. There is a cut in Pulgrave's "Artificial Changeling," published in 1650, showing that it was then very fashionable for the ladies to wear patches of black on their faces; among the rest, such as stars, the crescent, etc., appears a coach, with the coachman, horses, and a postilion, cut out of cloth, and pasted on her forehead. The author of "God's Voice against Pride in Apparel," published in 1663, says, "Methinks the mourning coach and horses, all in black, and plying in their [the women's] foreheads, stands ready harnessed to whirl them to Archeron." In the "Ladies' Directory"

¹ Coaches have been known to cross the Atlantic. A vessel called the *Coach*, and owned in England, touched at Boston in 1640. (Winthrop's *History of New England*, Vol. II, p. 23, 2d edit., Boston, 1853.) The council chamber of a man-of-war was called the "coach." (Pepys's *Journal*, May 3, 1660.)

(1674) we are informed that the "dear creatures" "had no doubt got a room in the Chronicles among the prodigies and monstrous beasts, had they been born with moons, stars, crosses and lozenges upon their cheeks, especially had they brought into the world with them a coach and horses!"¹

It is curious to watch the rate of progress in hackney-coaches. In 1652 they were limited by Act of Parliament to two hundred "in the Metropolis and six miles round it." In 1654 only three hundred were allowed, with six hundred horses to work them. In 1661 they numbered four hundred, at which they remained for thirty-three years. In 1694 they had increased to seven hundred. In 1715 they numbered eight hundred. In 1771 they reached one thousand in number. In 1832, when these hacks numbered twelve hundred, all restrictions were removed.

That the business of the watermen remained uninjured by the introduction of coaches, is manifest from the following circumstance related by Pepys, under date of 1659, when Taylor had been in his grave six years: "In our way to London Bridge we talked with our waterman, White, who told us how the watermen had lately been abused by some who had a desire to get in to be watermen to the State, and had lately presented an address of nine or ten thousand hands to stand by this Parliament, when it was only told them that it was a petition against hackney-coaches; and that to-day (Feb. 1) they had put out another to undeceive the world and clear themselves."²

Under the governments of Cromwell and Charles II coaches continued to increase in the face of all opposition. Even on the first day

¹ "This is the first day that ever I saw my wife wear black Patches." — PEPYS'S *Diary*, Feb. 30, 1660.

² A volume entitled "A century of the names and scantlings of such inventions, as at present I can call to mind, to have tried and perfected; which (my former notes being lost) I have, at the instance of a powerful friend, endeavored now, in the year 1655, to set them down in such a way as may sufficiently instruct me to put any of them in practice." This volume was written by Edward, the second Marquis of Worcester, and published by J. Grismond, London, 1663. The author mentions "a coach saving engine" among other ingenious inventions, described as "a little engine within a coach whereby a child may stop it, and secure all persons within it, and the coachman himself, though the horses be never so unruly in a full career; a child being sufficiently capable to loosen them, in what posture soever they should have put themselves, turning never so short; for a child can do it in the twinkling of an eye."

the king's proclamation went into effect against hackney-coaches, Pepys tells us he got one to carry him home.

According to Markland, who quotes from the "Diary of Sir William Dugdale," stage-coaches were established as early as 1659. They seem, however, to have multiplied very slowly, for we find that thirteen years afterwards there were but six in all England. But even this small number did not escape the condemnation of the censors, among whom was Sir H. Parnell. He says, "These stage-coaches make gentlemen come to London on very small occasions, which otherwise they would not do but upon urgent necessity; nay, the convenience of the passage makes their wives often come up, who rather than come such long journeys on horseback, would stay at home. Then when they come to town, they must presently be in the mode, get fine clothes, go to plays and treats, and by these means get such a habit of idleness and love of pleasure as makes them uneasy ever afterwards."

Post-chaises for private traveling came into use in 1664, and were close-bodied vehicles on four wheels, made to hold three persons inside, all facing forward, with glasses in front. These were drawn by two horses; a boy mounted on one acted as driver. The expense of posting was so great that it was usually shared by a fellow-traveler to lessen the cost. After the invention of railroads, as we shall find, these fell into disuse.

When springs were first invented is not known with certainty, but the following from Pepys's "Diary" may throw some light upon the subject. Under date of May 1, 1665, mention is made of the trial of springs applied to coaches, the body of which "lay upon one long spring," the contrivance of one Col. Edward Blount. A few months later he says, "For curiosity I went into [the Colonel's chariot] to try it and up the hill . . . and over the cart ruts, and found it pretty well, but not so easy as he pretends."¹ In a subsequent visit the same writer says he saw a coachman "sit astride upon a pole over the horse," which he considers "a pretty odd thing."²

"This morning," says Pepys, under date of March 15, 1666,³ "I was called up by Sir John Winter, poor man! come in a sedan from the

¹ Pepys's *Diary*, Sept. 5, 1665.

² *Ibid.*, Jan. 22, 1665-6.

³ In this year there was a great fire in London, before which time coaches were made narrow, so as to accommodate them to the narrow streets. Afterwards the streets were widened, and the coaches made more roomy.

other end of the town," etc., from which we infer their popularity was on the wane, although they were occasionally used. The public in general came to the conclusion that the use was "degrading Englishmen into slaves and beasts of burden," and consequently they soon were laid aside, and the horse littersubstituted in their place. The following incident, which took place in 1680, more than fifty years after the introduction of sedans,

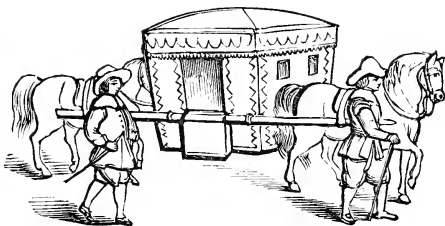

HORSE-LITTER.

gives us some insight of their inconveniences. "Can we forget," says an old author, "that horrid accident, when Major-General Skippon came in a horse-litter wounded to London? When he passed the Brew-house, near St. John Street, a mastiff flew as at a bear at one of his horses, and held him so fast that the horse grew mad as a mad dog; the soldiers were so amazed that none had the will to shoot the mastiff; but the horse-litter, borne between two horses, tossed the Major-General like a dog in a blanket."

The earliest allusion we have found to sliding glass windows, if indeed such are there spoken of, is a passage from Pepys's "Diary," dated Jan. 23, 1667. It reads thus: "Another pretty thing was my Lady Ashly's speaking of the bad qualities of glass-coaches: among others, the flying open of the doors upon any great shake: but another was that my Lady Peterborough being in her glass-coach with the glass up, and seeing a lady pass by in a coach whom she would salute, the glass was so clear that she thought it had been open, and so ran her head through the glass."

Coaches had now wonderfully increased, so that at the funeral of Sir W. Batten there were in attendance from one to two hundred in 1667; and at the funeral of Sir William Davenant, which occurred the next year, there were many coaches and hackneys in the procession to Westminster Abbey, which Pepys says "made it look, methought, as if it were the buriall of a poor poet." The same year there were, on a certain occasion, "one thousand coaches" in Hyde Park at the same time.

The vehicle we call a chariot is mentioned under date of June 25, 1667, by Pepys in the following words: "Up and with Sir W. Penn in his new chariot (which indeed is plain, but pretty and more fashionable in shape than any coach he hath, and yet do not cost him, harness and all, above £32) to Whitehall," etc. The chariot was a favorite carriage with many for over a hundred years, its cheapness and lightness, when contrasted with the coach, being important considerations.

With the end in view of increasing trade, the proprietors of the stage-coaches running to London dubbed them "flying-coaches," thereby conveying the impression that they were fast traveling. Hearne thus alludes to them in his "Life of Anthony à Wood": "An. Dom. 1669, April 26 (20 Carolus II) Monday was the first day that the flying coach went from Oxford to London in one day. Anthony à Wood went in the same Coach, having then a Boote on each side.¹ Among the six men that went, Mr. Rich. Holloway of Oxon (afterwards a judge) was one. They then (according to the Vice Chancellor's orders, stuck up in all public places) entered into the Coache at the Tavern Dore of All Souls' College, precisely at six of the clock in the morning, and at seven at night they were set down in their Inn at London."²

But now the stage-coaches come in for their share of opposition from "A Lover of his Country,"—supposed to have been one John Cressett,—who published a pamphlet in 1673 with the high-sounding title of "The Grand Concern of England explained," wherein several proposals are advanced for the consideration of Parliament and the benefit of the people, one of which is, "that the multitude of stage-coaches and caravans now traveling upon the roads may all or most of them be suppressed, especially those within sixty miles of London,

¹ The "boote" alluded to appears to have been projections at the sides, like those seen in Queen Elizabeth's coach (page 266), made for the accommodation of passengers, who, when seated, sat back to back in the coach. The present construction of the carriages of the Lord Mayor and the Speaker, in which these officers are so placed as to look out at the side windows, may have originated when "the boote" disappeared. But, as Hearne observes (*Wood's Diary*, p. 80), "Mr. Speaker's coach, however cumbersome, gives an adequate idea (as the editor of Bassompierre's *Embassy to England*, in 1626, justly observes) of the vast machines of former days, which were rather closets on wheels than what we would call coaches."

² Hearne's *Life of Anthony à Wood*, Oxford, 1772.

where they are no way necessary, but do great mischief by hindering the breed of horses, the breed of watermen, and besides lessen his Majesty's revenues." The "Lover of his Country" dwells with much bitterness on the effeminacy which stage-coaches engender in his Majesty's subjects, and says, "Hereby they become weary and listless when they ride a few miles, unwilling to get on horseback, and unable to endure frosts, snow, or rain, or to lodge in the fields." That stage-coaches hinder the breed of horses is evident, "for will any man keep a horse for himself, and another for his man, all the year, for to ride one or two journeys; that at pleasure, when he hath occasion, can slip to any place where his business lies for two, three, or four shillings, if within twenty miles of London, and so proportionately into any part of England? No; there is no man, unless some noble soul, that scorns and abhors being confined to so ignoble, base, and sordid a way of traveling as these coaches oblige him unto, and who prefers a public good before his own ease and advantage, that will breed or keep such horses. Neither are there near as many coach-horses either bred or kept in England now as there were saddle-horses formerly, there being no occasion for them, the kingdom being supplied with a far less number. For formerly every man that had occasion to travel many journeys yearly, or to ride up and down, kept horses for himself and servants, and seldom rid without one or two men; but now, since every man can have a passage into every place he is to travel unto, or to some place within a few miles of that part he designs to go unto, they have left keeping of horses, and travel without servants; and York, Chester, and Exeter stage-coaches, each of them with forty horses apiece, carry eighteen passengers a week from London to either of these places, and, in like manner, as many in return from these places to London, which came in the whole to eighteen hundred and seventy-two in the year. Now take it for granted that all that are carried from London to these places are the same that are brought back, yet are there nine hundred and thirty-six passengers carried by forty horses; whereas, were it not for these coaches, at least five hundred horses would be required to perform this work. Take the short stages, within twenty or thirty miles of London: each coach, with four horses, carries six passengers a day, which are thirty-six in a week, eighteen hundred and seventy-two in a year. If these coaches were suppressed, can any man imagine these eighteen hundred and

seventy-two passengers and their servants could be carried by four horses? Then reckon your coaches within ten miles of London, that go backward and forward every day, and they carry double the number every year; and so, proportionably, your shorter stages within three, four, or five miles of London. There are stage-coaches that go to almost every town within twenty or twenty-five miles of London, wherein passengers are carried at so low rates that most persons in and about London and Middlesex, Essex, Kent, and Surrey, gentlemen, merchants, and other traders, that have occasion to ride, do make use of: some to fairs and markets; others to visit friends, and to go to and from their country-houses, or about other business; who, before these coaches did set up, kept a horse or two of their own, but now have given over keeping the same. So that, by computation, there are not so many horses by ten thousand kept now in these parts as there were before stage-coaches set up."

The "Lover of his Country," in sympathy with our old enemy John Taylor, says these stage-coaches "hinder the breeding of watermen, and much discourage those that are bred," by the setting up of them on both sides of the Thames, as high up as Maidenhead, to down below Gravesend, "carrying all the letters, little bundles, and passengers, . . . the consequence whereof is like to prove sad in a short time, unless speedily prevented; especially if these wars continue, and we happen to lose so many yearly of those that are bred, as of late years we have done. But if these coaches were down, watermen, as formerly, would have work, and be encouraged to take apprentices, whereby their number would greatly increase."

The "Lover of his Country" in the same strain goes on to tell us how his Majesty's revenues are lessened: "Now four or five travel in a coach together, and twenty or thirty in a caravan (gentlemen and ladies, without any servants), consume little drink on the road, yet pay as much at every inn as if their servants were with them, which is the tapster's gain and his Majesty's loss. . . . Before these coaches were set up, travelers rode on horseback, and men had boots and spurs, saddles, bridles, saddle-cloths, and good riding suits, coats and cloaks, stockings and hats, whereby the wool and leather of the kingdom was consumed, and the poor people set at work by carding and fulling, and your cloth-workers, drapers, tailors, saddlers, tanners, curriers, shoemakers, spinners, lorimers, and felt-makers had a good

employ, . . . lived handsomely, . . . and helped with their families to consume the provisions and manufactures of the kingdoms." Besides, "Most gentlemen, before they traveled in coaches, used to ride with swords, belts, pistols, holsters, portmanteaus, and hat-cases, which in these coaches they have little occasion for. For when they rode on horseback, they rode in one suit, and carried another to wear when they came to their journey's end or lay by the way; but in coaches a silk suit and an Indian gown, with a sash, silk stockings, and beaver hats men ride in, and carry no other with them, because they escape the wet and dirt, which on horseback they cannot avoid; whereas, in two or three journeys on horseback, these clothes and hats were wont to be spoiled, which done they were forced to have new very often, and that increased the consumption of the manufactures and the employment of the manufacturers. . . . And if they were women that traveled, they used to have safeguards and hoods, side-saddles and pillions, with strappings, saddle or pillion cloths, which for the most part were either laced or embroidered, to the making of which there went many several trades; seeing there is not one saddle, with the furniture, but before it is furnished there are at least thirty several trades have a share in the making thereof, most of which are either destroyed or greatly prejudiced by the abatement of their trade, which being bred unto, and having served seven years' apprenticeship to learn, they know not what other course to take for a livelihood. . . . The milliners and haberdashers, they also sold more ribbons, gloves, scarfs, and other things belonging to their trade; the dust, dirt, and rain, and riding on horseback, spoiling and wearing them out much more than traveling in a coach, and on horseback these things were apter to be lost than in a coach."

As numerous trades are concerned in producing the articles mentioned by "A Lover of his Country," he insists upon it that all such must be injured by running stage-coaches, "especially the country trade all over England; for, passage to London being so easy, gentlemen come to London oftener than they need, and their ladies either with them, or having the conveniences of these coaches, quickly follow them. And when they are there they must be in the mode, have all the new fashions, buy all their clothes there, and go to plays, balls, and treats, where they get such a habit of jollity, and a love to gayety and pleasure, that nothing afterwards in the country will serve them,

if ever they should fix their minds to live there again; but they must have all from London, whatever it costs. . . . Country ladies would be as well pleased, provided they be kept from London, as if they had all the rich clothes, modes, and fashions, vainly and extravagantly invented, and worn in the city, . . . and gentlemen would not only save the money they spend in journeys to buy clothes, but have as good as need to be worn in the country. . . . Men do not travel in these coaches with less expense . . . than on horseback."

Traveling in these stage-coaches is neither beneficial to men's health nor business, for what advantage is there in being called out of bed an hour before morning to be hurried from place to place all day in the summer-time, "stifled with heat and choked with dust; or in the winter-time, starving and freezing with cold or choked with filthy fogs, . . . often brought into their inns by torchlight, when it is too late to sit up to get a supper; and next morning they are forced into a coach so early that they can get no breakfast, . . . to ride all day with strangers, oftentimes sick, ancient, diseased persons, or young children crying; to whose humors they are obliged to be subject, forced to bear with, and many times are poisoned with their nasty scents, and crippled by the crowd of the boxes and bundles? . . . To travel in rotten coaches, and to have their tackle, or perch, or axle-tree broken, and then to wait three or four hours (sometimes half a day) to have them mended, and then to travel all night to make good their stage? . . . To be affronted by the rudeness of a surly, dogged, cursing, ill-natured coachman; necessitated to lodge or bait at the worst inns on the road, where there is no accommodation fit for gentlemen; and this merely because the owners of the inns and the coachmen are agreed together to cheat the guests? . . . Rather the quite contrary."

This "Lover of his Country" continues: "These coaches are not absolutely necessary to any persons whatever," as the sick, old, and young "may ride in the long wagon-coaches, which were those that were first set up, and are not now opposed, because they do little or no hurt; . . . and truly, if they be poor people that are to travel, it is not fit they should be encouraged in their pride and extravagancy, or suffered to ride amongst gentlemen or like persons of honor, in a coach with four or six horses, . . . jolting men's bodies or hurrying them along, as the running coaches do, . . . kept by such

as, before the late act for reducing the number of hackney-coaches in London to four hundred, were owners of coaches, and drove hackneys there." These persons employ "only a few servant-coachmen, postillions, and hostlers, whom they pretend they breed up, and make fit for the service of the nobility and gentry of the land: a most incomparable school to train men up in and fit them for the gallows more likely than to live in sober families!"

The ill condition of the roads at this time, and the consequent trials in traveling, are well illustrated by the letter of Edward Baker to his father, in 1673: "Honored Father — My dutie premised, &c., I got to London on Saturday last; my journey was noe ways pleasant, being forced to ride in the boote all the waye, y^e company y^t came up wth mee were persons of greate quality, as knights and ladyes. My journey's expense was 30 s. This traval hath soe indisposed mee y^t I am resolved never to ride up againe in y^e coach."

When James II abdicated the throne, the fact was not known in the Orkneys until three months after the event. Subsequently the Duke of Somerset was accustomed, when he went from London to Pentworth, to send a letter beforehand requesting "the keepers and persons who knew the holes and the sloughs, to come to meet His Grace, with lanthorns and long poles, to help him on his way." The usual mode of conveyance at this period for the humbler classes was in long and cumbrous wagons or caravans, when they went from town to town. These were drawn by four and sometimes five horses, carrying from twenty to twenty-five passengers. M. Soubirere, a Frenchman who visited England about this time, writes, "That I might not take post or again be obliged to use the stage-coach, I went from Dover to London in a wagon. I was drawn by six horses placed in a line, one after another, and driven by a wagoner, who walked by the side of it. He was clothed in black, and appeared in all things like another St. George. He had a brave monteror on his head, and was a merry fellow, fancied he made a figure, and seemed mightily pleased with himself." From this we discover that the struggle for popularity between the traveling wagon and the comparatively new stage-coach was protracted and severe.

Coach-making had now become a very important business in the metropolis, where the better class of work was done. As might be expected, the craft organized a society, which was incorporated May

21, 1677. On the 17th of July following, a coat-of-arms¹ was granted to the Worshipful Company of Coach and Coach-harness Makers by Sir William Dugdale, Knt. Garter, and Sir Henry St. George Norray, in the twenty-second year of the reign of Charles II, of which a *fac-simile* is presented. The benefactions to this society date as far back as 1703, as we learn from a perusal of the records preserved at the hall

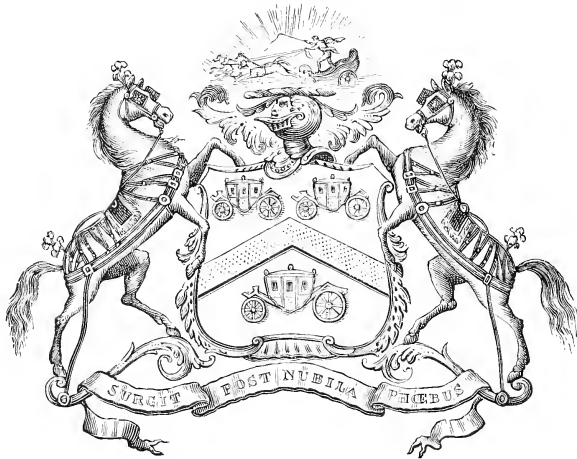

COACH-MAKERS' ARMS, 1667.

of the company in Noble Street, Foster Lane, London. Since then new arms have been adopted by this ancient guild somewhat differing from the original. A second society, "The Master Coach-builders' Benevolent Institution," was organized Jan. 22, 1856; and a third, "The Operative Coach-makers' Benevolent Society," in 1860. The objects of these modern institutions are sufficiently indicated in the titles.

¹ These are thus described in Edmonson's *Work on Heraldry*, London, 1780: —

"ARMS. — Az. chevron between three coaches or. CREST. — On a wreath-cloud proper; thereon the figure of Phœbus driving the chariot of the Sun or. drawn by four horses or. harnessed, reined, and bridled of the second. SUPPORTERS. — Two horses or. harnessed and bridled fa. studded or. garnished gu. housings az. fringed and purpled of the third: each horse adorned on the head with a plume of four feathers of the following colors, viz. or. ar. az. and gu. MOTTO. — *Surgit Post nubila Phœbus.*"

Some idea of the cost of a chariot a few years later may be learned from an entry found in Sir William Dugdale's "Diary," the gentleman mentioned in the preceding paragraph. It stands thus: "1681. Payd to Mr. Mears, a coach-maker in St. Martins-Lane, for a little chariot, which I then sent into the countrie, £23. 13s. 0*d.* [about \$161], and for a cover of canvass, £1; also, for harness for two horses, £4."

The comforts and conveniences of a coach are thus set forth by the philosopher Boyle, in 1682: "As fast as this coach goes, I sit in it so much at ease, that whilst its rapid motion makes others suspect that I am running for a wager, this lazy posture and this soft seat do almost as much invite me to rest as if I were a-bed."

"The hasty wheels strike fire out of the flints they happen to run over, and yet this self-same swiftness of these wheels, which, were I under them, would make them crush my bones themselves into splinters, if not into a jelly, now I am seated above their reach, serves but to carry me the faster towards my journey's end."

Some idea of the style in which coaches were built in 1688 may be obtained from an inspection of the following engraving, copied from a rare print by Romaine de Hooge, in which William III is represented

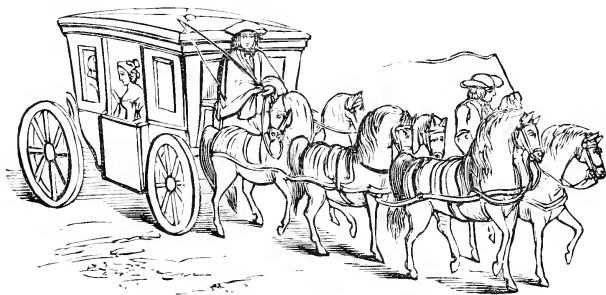

COACH AND SIX OF 1688.

as making his entry into the royal palace at Whitehall in "a coach and six" for the first time, with a man outside on the box, and a postilion astride one of the leaders. In this drawing "the boote" at the side still appears, as it did in the time of Queen Elizabeth, with a female seated sideways, and riding "crab fashion," as John Taylor sarcastically terms it. This coach is described as having been mounted on

springs, although such do not appear in the drawing. The dickey-seat now appears for the first time, which, besides accommodating the driver, carried inside a hammer, nails, pincers, ropes, and such other articles as were required in case of accident for repairing the vehicle. Afterwards "the hammercloth" was added in order to hide the box, the unsightly receptacle of remedies for broken wheels, shivered panels, and other damaged portions of the coach, caused by bad roads, and perhaps some mismanagement on the part of inexperienced coachmen.

Near the end of the seventeenth century (1696) the coach had assumed the form represented in the next engraving, which is copied from a well-executed copperplate print in the British Museum. Here

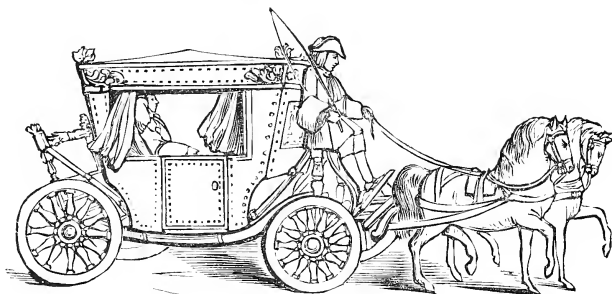

COACH OF 1696.—FROM A PRINT IN THE BRITISH MUSEUM.

we find that a foot-board for the driver is provided. The body, although designed for something nice, is less graceful in the lines than the former. The sun-curtains are now seen for the first time, likewise the standards as supports to the thorough-braces on which the body is suspended. The artist has not only delineated the carvings, but likewise shown us the nail-heads used to secure the leather-jacket to the frame-work.

In striking contrast with the preceding is the carriage represented in the next figure, the original of which is owned by the Earl of Darnley, who lent it for the International Exhibition in South Kensington, London, where we saw it in 1873. It is reported to have been a present to the older Earl from Mary Queen of Scots during her brief reign. For many years it has been carefully preserved at Peushurst

in Kent. It is without doubt a production of a much later date than the age of Elizabeth (probably about 1700), in whose time Mary was beheaded, and has superior claims to beauty, both in model and finish, over anything shown during her reign. The elaborately carved spokes,

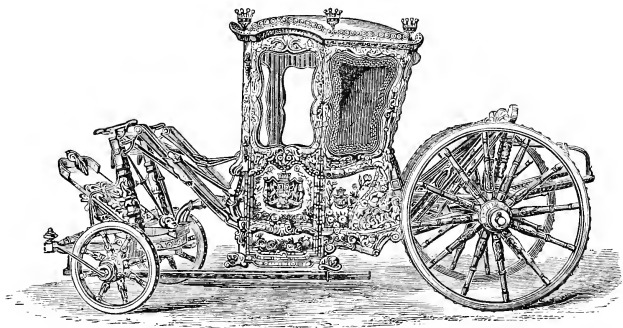

CHARIOT OF THE EARL OF DARNLEY.

standards, and moldings of the body must have severely taxed the patience and ingenuity of the artist in "getting it up." Instead of the box, this has a "standee" seat for the driver, and, as Fairholt observes, "is a good example of the sort of carriage then used by the nobility. Nothing," he continues, "can exceed the finish and beauty of the decorations; the hinges have projecting ornaments, terminating in busts of the Roman emperors; and the carving and other ornaments have a finish that could not be excelled." Although an improvement in shape and size is here visible, yet "there is an overruling clumsiness about the whole which contrasts very forcibly with the more modern coach."¹

In 1698 a pamphlet appeared, entitled "An Elegy on the Death of Trade, by a Relation of the Deceased," in which appears the following curious mixture:—

"There were Gun-smiths and Cuttlers,
And Founders and Suttlers,
And Coach-makers a great many :
There were Coblers and Tinkers,
Those honest ale-drinkers,
And Shoemakers, too, more than any";

¹ London *Art Union Journal*, 1847, p. 160.

showing that at the end of the seventeenth century trade was at a low ebb.

In December, 1703, we have a picture of the times related by Markland in the "Archæologia": "Charles, King of Spain, slept at Pentworth, on his way from Portsmouth to Windsor, and Prince George of Denmark went to meet him there. We set out (as one of the attendants relates) and did not get out of the coach (save only when we were overturned or stuck fast in the mire) till we arrived at our journey's end. It was hard service for the Prince to set fourteen hours in the coach that day, without eating anything, and passing through the worst ways I ever saw in my life. We were thrown but once, indeed, in going, but both our coach (which was the leading one) and his Highness's body-coach would have suffered very often if the nimble boors of Sussex had not frequently pushed it or supported it with their shoulders, from Godalming almost to Pentworth; and the nearer we approached to the Duke's house, the more unaccessible it seemed to be. The last nine miles of the way cost us six hours' time to conquer them, and, indeed, we had never done it if our good master had not several times lent us a pair of horses out of his own coach, whereby we were enabled to trace out the way for him." His Grace's park and the common roads were about alike impassable.

We are told that the hoop-skirts of the ladies had attained such enormous dimensions in 1707 as to claim the notice of the satirists and others. It is related in a periodical of the time (satirically, of course) that "for the service of ladies wearing hoops, one Bill Jingle, coach-maker, has built a round chair, in the form of a lantern, six yards and a half in circumference, with a stool in the middle of it, so as to receive the passenger by opening in two in the middle, and closing mathematically when she is seated." Besides the foregoing *useful* invention, Bill Jingle invented another coach into which the *hooped ladies* of that day were admitted from the top. "A lady's woman" in her hooped petticoat was even let down from a balcony and drawn up again by pulleys, to the great satisfaction of "my lady," and all who beheld the interesting scene.

At this time a writer in "The Tattler" complains that "the horses and slaves of the rich take up the whole street; while the peripatetics are very glad to watch an opportunity to whisk cross a passage, very thankful that we are not run over for interrupting the machine that

carries in it a person neither more handsome, wise, nor valiant than the meanest of us. For this reason, were I to propose a tax, it should certainly be upon coaches and chairs; for no man living can assign a reason why one man should have half a street to carry him at his ease, and perhaps only in pursuit of pleasures, when as good a man as himself wants room for his own person to pass upon the most necessary and urgent occasions. Until such an acknowledgment is made to the public, I shall take upon me to vest certain rights in the scavengers of the cities of London and Westminster, to take the horses and servants of all such as do not become, or deserve such distinctions, into their peculiar custody. The offenders themselves I shall allow safe-conduct to their places of abode in carts of said scavengers, but their horses shall be mounted by their footmen and sent into the service abroad; and I shall take this opportunity, in the first place, to recruit the regiment of my good old friend, the brave and honest Sylvius." This writer further says, "I have given directions to all the coach-makers and coach-painters in town to bring me in lists of their several customers; and doubt not, but with comparing the orders of each man, in the placing his arms on the door of his chariot, as well as the words, devices, and ciphers to be fixed on them, to make a collection which shall let us into the nature, if not the history of mankind, more usefully than the curiosities of any medalist in Europe."

The next illustration is copied from a print representing a procession of the members of both Houses of Parliament to St. Paul's Cathedral

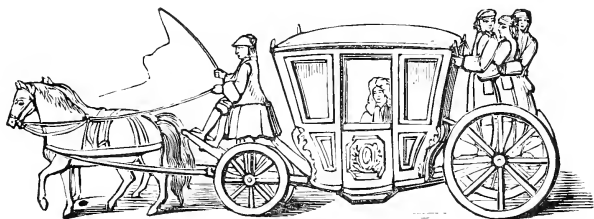

STATE COACH OF 1713.

in the reign of Queen Anne, July 7, 1713, to return public thanksgiving to God for the Peace of Utrecht. It is supposed to represent the fashions in coaches at the time "when stateliness was chiefly considered, and as many footmen carried behind as could be conveniently

borne; two, three, and four of these useless incumbrances generally appeared, while on state occasions the absurd number of six hung on behind, clasping each other's waists; an uncomfortable mob, and a living satire on the pride which hired and supported such cumbrous adjuncts."

The next illustration, taken from the same print as the foregoing, is a singular one in many respects. It looks very much like an attempt to imitate the sedan-chair we have previously considered in these pages. The carriage-body is thrown back upon the perch in a singular manner,

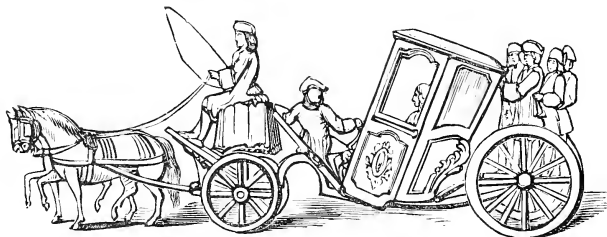

SEDAN CHARIOT OF 1713.

which must have rendered it a hard thing to travel in. The coachman is more to be envied than either of the other attendants, he alone being furnished with a comfortable seat. Not content with two, the stateliness of the occupant requires no less than five footmen, — four behind, and one *perched* on the front in a rather uncomfortable position. Could this circumstance — the *perching* of a footman on the reach — have given to it the name of a "perch," as this portion of the vehicle is frequently called?

Queen Anne was accustomed to go year after year to congratulate the Duke of Marlborough on his successes, and in processions, after the members of the House of Commons, headed by their Speaker, the Masters of Chancery, the Judges, and the Peers of the realm, in these low hanging coaches, to open Parliament, as well as in the public processions to St. Paul's. One of these pageants is thus described: "Then came the Queen in her state equipage, drawn by eight horses, and having by her side the Duchess of Marlborough, the wife of the Conqueror, and her Majesty's early and bosom friend. The streets through which the procession passed were lined by the Westminster militia and the city trained bands; the balconies and

windows were hung with fine carpets and tapestries, and crowded with spectators. The Queen was received at St. Paul's by the Peers, and preceded into the choir by the great man himself, Marlborough, carrying the sword of state."

Two years later Queen Anne went to St. Paul's again for a similar purpose; and very soon after disowned the man to whom she owed so much, dismissed him from all employment, and left him as helpless as it was possible to meet the charges of peculation which his enemies had brought against him. The "dear Mrs. Freeman," as the Queen delighted to call the Duchess (she herself assuming the name of Mrs. Morley), was now as much hated as she had been previously loved, though with some reason: there is no doubt the masculine-minded spouse of Marlborough endeavored to advance his interests and the interests of his party with too high a hand, and in a kind of reckless forgetfulness of her misfortunes and very decided political principles.

The poet Gay has left us a vivid picture of some of the common accidents in the reign of this queen, when cartmen were the greatest enemies of coaches. He says in the "Trivia": —

"I've seen a beau, in some ill-fated hour,
When o'er the stones choked kennels swell the shower,
In gilded chariot loll; he with disdain
Views spattered passengers all drenched in rain;
With mud filled high, the rumbling cart draws near.
Now rule thy prancing steeds, laced charioteer!
The dustman lashes on with spiteful rage;
His ponderous spokes thy painted wheels engage, —
Crushed is thy pride, down falls the shrieking beau,
The shabby pavement crystal fragments strow;
Black floods of mire the embroidered coat disgrace,
And mud enwraps the honors of his face."

And again, —

"Where a dim gleam the paly lantern throws
O'er the mid-pavement, heapy rubbish grows,
Or arched vaults their gaping jaws extend,
Or the dark caves to common sewers descend;
Oft, by the winds, extinct the signal lies,
Or, smothered in the glimmering socket, dies —
Ere night has half roll'd round her ebon throne.
In the wide gulf the shattered coach, o'erthrown,
Sinks with the snorting steeds; the reins are broke,
And from the crackling axle flies the spoke."

The kind of carriage used for traveling in the times of George I and II may be seen below, drawn by six horses, the foremost of which is ridden by a postilion with heavy jack-boots and spurs. The form of the body is similar to the one preceding the last, and like it has footmen perched up behind. A footman precedes the carriage, having in

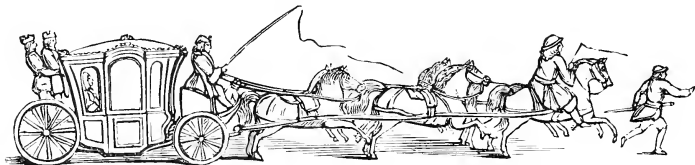

CARRIAGE OF THE ARISTOCRACY.—TEMP. GEORGE I AND II.

his hand a gold-headed cane. These footmen, attendant upon the English aristocracy under the pretense of clearing the way, are said to have been copied from Oriental usages. They were gayly attired in clothes of value, and an amusing tale is related of a smart chap who "came it over" the Duke of Queensbury by applying to him for a situation, and having been supplied with a suit of clothes, he afterwards gave his unsuspecting Grace a fine specimen of his fitness for the situation he had assumed by running up Piccadilly until he fairly outstripped the horses, and disappeared in the crowd with the garments he wore.¹ This example is what is called "a coach and six," meaning a coach drawn by six horses. The extra horses were added for show, as well as the attendants.

Though built somewhat lighter than formerly, these coaches were an improvement over those preceding them, but still very clumsy, and calculated to last a long time. In fact, some of these were, in the strictest sense, "heirlooms," remaining a long time in the family, and kept in repair for its use.² The antiquary, Brown Willis, had one of these, which a contemporary writer thus describes: "The chariot of Mr. Willis was so singular that from it he was himself called 'The Old

¹ "These men," says Fairholt, "filled the place of the modern coach-dog, being about as useful, and not quite as ornamental. They disappeared in the reign of George the Third."—*London Art Journal*, 1847, p. 245.

² A correspondent of *The N. Y. Coach-maker's Magazine*, George N. Hooper, Esq., Coach-maker to her Majesty, says, "The best London carriages are not only very highly finished, but are so soundly put together that many are kept in use that have been running (with periodical repairs) twenty-five, thirty, and even forty years."

Chariot.' It was his wedding-chariot, and had his arms on brass plates about it, not unlike a coffin painted black." Dr. Darrell humorously satirized it in one stanza, which ran thus:—

“ His car himself he did provide
To stand in double stead,
That it should carry him alive,
And bury him when dead.”

From a desire of introducing something lighter, the *sedan-cart* was invented, *capable of being drawn by a single horse*, although, viewed from a modern standpoint, it would appear clumsy enough. This was

designed for the use of a single person, in times when crinoline did not spread itself quite as much as it has since, but two might be got in by squeezing. The body, as may be seen, is peculiar in form, accommodated to a reclining position. This



SEDAN-CART.

reclining position was originally obtained in hanging off the body, but here it is furnished by accommodating construction. Hung off without springs, on two wheels, placed far from the horse and subjected to his amblings, this vehicle must have proved a miserable *pleasure-carriage*. The driver has about the best seat, and for invalids to ride in, the vehicle, we should judge, would be certain death. They are said to have been used by the middle classes only.

Such was the condition of the roads in the country that sedan-chairs were used in place of carriages, and were even fashionable among the nobility and gentry of London, where they were used in visiting public places of amusement and in making social calls upon their friends. For these purposes they were in much demand, although the great number produced much inconvenience in the crowded streets of cities, by the disputes for precedence, which were often of the most violent nature. An example of this kind may be found in "Mist's Journal" of Saturday, July 8, 1721, which shows that manners have changed somewhat within a century and a quarter. We read that, "On Thursday se'might the Right Honorable the Lord Carteret, one of her Majesty's principal Secretaries of State, passing through St.

James's Square in a chair, was met by the Lady Harley in another, when, a dispute arising between the footmen about giving the way, they immediately came to blows, and the chairman and footmen being engaged with their poles and sticks, one of them struck his lordship as he was getting out of his chair, but whether accidentally or designedly we know not. In the mean time that person is committed to Newgate, and three of his brethren are bound over to the next session."

In 1731 the English government imposed a tax on the owners of coaches. Then again rhyme was invoked to the rescue: —

"Before *Bohemian Anne* was queen,
 Astride their steeds were ladies seen;
 And good Queen Bess to Pauls I wot,
 Full oft aside has jogg'd on trot:
 Beaus then could foot it through all weather,
 And nothing fear but wear of leather.
 But now (so luxury decrees)
 The polished age rolls on at ease;
 Coach, chariot, chaise, berline, landau,
 (Machines the ancients never saw),
 Indulge our gentler sons of war,
 Who ne'er will mount triumphant car.
 The carriage marks the peer's degree,
 And almost tells the doctor's fee;
 Bears every thriving child of art: —
 Ev'n thieves to *Tyburn* claim their cart.

"O cruel law! replete with pain,
 That makes us use our legs again:
 Or, half our pain obliged to lack,
 Bids us bestride the others back.
 A skulky stage would suit with many,
 Who cannot reach an eighteen penny.
Rack must enhance the price of pills,
 Or drive again — on pair of wheels.
 The goodmate too will be to seek
 Who mounts his chariot twice a week:
 Or if the Hackneyman should grumble,
 I fear our Phaeton must tumble.
 O cruel law! to raise the fare
 Of christmas turkey, chine and hare:
 The 'vails on wages to retrench
 Of county serving man or wench,
 Who twice a year ride up and down,
 Betwixt their native place and town.

“O cruel tax! who must not say!
Which only those who will — need pay?”

The following advertisement appears in the “Gentlemen’s Magazine” for 1731: “Married the Rev. Mr. Roger Waina, of York, about 26 years of age, to a Lincolnshire lady upwards of eighty, with whom he is to have £8,000 in money, £300 per annum, and a coach-and-four during life, only.”

In a former chapter we have given a sedan-chair from Sandys’s “Travels,” and in this, on page 293, added another from “Coach and Sedan.” It may interest the reader to compare the much-improved sedan with those aforementioned.¹ The sedan of 1750 was richly decorated with brass chasings, moldings, carvings, and tassels. It is much lighter, too, than previously made, and more artistic taste is shown in the form of the body. This was in use for many years. Probably it is to this chair Dean Swift alludes, when he says, —

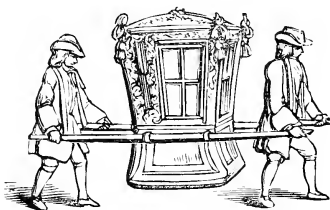

ENGLISH SEDAN-CHAIR, 1750.

“Box’d in his chair, the beau impatient sits,
While sprouts run clattering o’er the roof by fits,
And ever and anon, with frightful din,
The leather sounds — he trembles from within!”

The chair here depicted was for private use, furnished with crimson velvet cushions and damask curtains, and the chairmen generally were sturdy, athletic Milesians, reveling, where employed by the aristocracy, in all the finery of embroidered coats, epaulettes, cocked hats, and feathers. The public sedans were of a more democratic caste, trimmed with plain leather, secured by brass nails, as may be seen in Hogarth’s plate of “The Rake’s Progress,” where he is represented as going to a levee at St. James’s. “The hackney² chairmen exerted the

¹ It is related that Charles I, on his return from Spain, where he had gone on a *courting expedition* to the fair princess, daughter of Philip IV, brought back with him three sedan-chairs of very curious workmanship.

² As early as 1744, when there were only six regular stage-coaches in all England, light-bodied chariots were advertised in London, “fit either for town or country, carriages on springs beginning then to supersede the wagon-like coaches of former days.” — *Note to Lady Hervey’s Letters*, p. 57.

power of the strong arm, and were often daring enough, as a body, to influence the fate of Westminster and Middlesex elections in the terror which they produced with fist and bludgeon. But they are gone. No Belinda now may be proud of 'two pages and a chair.' They glide not among the chariot-wheels at a levee or in a drawing-room; the club wants them not. They have retired to Bath and Oxford. We believe there is one chair still lingering about May Fair, but the chairmen must be starving, and the Society of Antiquarians ought to buy the relic."¹

Below may be seen about the last type of an extremely old-fashioned coach. After this (1750) they were made according to an improved and much lighter pattern, under various names, which seem in this respect to have rivaled France. Instead of being made close, some



ENGLISH PRIVATE COACH, 1750.

of them were open and airy, suited to summer travel.² That which particularly claims notice in the engraving is the profuse and elaborate carving on the panels and quarters of the body. This coach appears to have been hung off without a perch, very low to the ground, the hammer-cloth seat maintaining its dignity; and although the foot-

¹ London *Once a Week*.

² This was about the time turnpike roads were introduced into England, effecting great changes in the mode of traveling. "A tradition exists in Scotland, as I am informed by Sir Walter Scott, that chairs or chariots were first introduced into that country in 1745. The nobility were accustomed to travel previously in vehicles resembling Noah's ark, and the gentry on horseback; but in that memorable year the Prince of Hesse appeared in a carriage of the description just mentioned, to the admiration of all Scotchmen, who regarded it as a coach cut in half." — BREWSTER'S *Encyclopædia*, Art. "Carriage."

men are absent, the construction of the coach leads to the conclusion that they must be around *somewhere*.

The following announcement is taken from a periodical of the time: "This day [1750] a remarkable carriage set out from Aldergate-street for Birmingham, from which town it arrived on Thursday last, full of passengers and luggage, without using coomb, or any oily, unctuous, or any liquid matter whatever, to the wheels or axle, its construction being such as to render all such helps useless. The inventor has caused to be engraven on the wheels, *Friction Annihilated*; and is very positive that the carriage will continue to go as long and as easy, if not longer and easier, without greasing, than any of the ordinary stage carriages will do with it. This invention, if really answerable in practice, is perhaps the most useful improvement in mechanics that this century has produced."

Our next illustration is a drawing of an English *single-horse gig* of 1754, which is supposed to be the original of the more modern Stanhopes, tilburies, whiskies, Dennetts, and buggies, of which we shall have occasion to speak hereafter. Here the old gentleman is seen jogging leisurely along, with his horse at a trotting gait. The body of the gig, rude in design, is hung off on leather straps pendent from iron braces at the back, springs not yet having become fashionable in two-wheeled carriages.

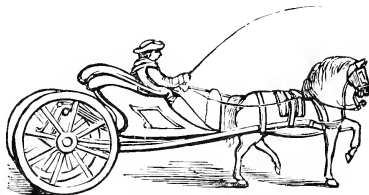

ENGLISH GIG, 1754.

In August of the same year appeared an advertisement stating "That a handsome Machine, with steel springs for the ease of passengers and the Conveniency of the Country, began on Monday, the 8th of July, to set off from Chelmsford every morning at 7 o'clock, Sunday excepted, to the Bull Inn, Leaden Hall Street, to be there by 12 o'clock, and return the same day at 2 o'clock, and to be at Chelmsford by 7 in the evening. Fresh horses will be taken at the White Hart at Brentwood and the Green Man at Ilford. To be performed, if God permits, by Tyrrell and Hughes."

About this time the following inventor's advertisement appeared: "All the Nobility and Gentry [in England] may have the carriages

of their Coaches made new, or the old ones altered after this new invention, at reasonable Rates; and Hackney and stage-coachmen may have Licences from the Patentee, Mr. *John Green*, and Mr. *William Dockura* his partner, at the rate of 12*l.* per week, to drive the Roads and streets, some of which having this week begun, and may be known from the common Coaches by the words Patent Coaches, being over both doors in carved letters. These Coaches are so hung as to render them easier for the Passenger and less labor to the Horses — The Gentleman's Coaches turning in narrow Streets and Lanes in as little or less room than any *French* carriage with Crane-neck and not one third part of the charge. The manner of the Coachman's sitting is more convenient, and the motion is like that of a Sedan, being free from that tossing and jolting to which other Coaches are liable over rough and broken Roads, Pavements or Kennels. These great conveniences (besides others) are Invitations sufficient for all Persons (that love their own ease and would save their horses' draught), to use these sort of Carriages and no other, since these Coaches need no alteration. All persons may be further informed at Mr. *Green's* house, in Carteret Street, by the cock-pit Royal in Westminster, and at Mr. *Dockura's* house in *Little Saint Helen's* in *Bishopsgate Street*, who hopes his Partner and he shall fare better by this Invention than he did by setting up that of the Penny Post."

From the "Tales of an Antiquary" we take the following description of stage-coaches in 1755: "In my young days, stage-coaches were constructed principally of dull black leather, thickly studded by way of ornament with black, broad-headed nails, tracing out the panels, in the upper tier of which were four oval windows, with heavy red wooden frames, or leather curtains. Upon the doors, also, were displayed, in large characters, the names of the places where the coach started and whither it went, stated in quaint and antique language. The vehicles themselves varied in shape. Sometimes they were like a distiller's vat, somewhat flattened, and hung equally balanced between the immense front and back springs. In other instances they resembled a violoncello-case, which was, past all comparison, the most fashionable form; and then they hung in a more genteel posture, namely, inclining on the back springs, and giving to those who sat within the appearance of a stiff Guy Fawkes uncasily seated. The roofs of the coaches, in most cases, rose in a swelling curve, which was sometimes

surrounded by a high iron guard. The coachman and the guard, who always held his carbine ready cocked upon his knee, then sat together, not, as at present, upon a close, compact, varnished seat, but over a very long and narrow boot, which passed under a large, spreading hammer-cloth, hanging down on all sides, and finished with a flowing and most luxuriant fringe. Behind the coach was an immense basket, stretched far and wide beyond the body, to which it was attached by long iron bars or supports passing beneath it, though even these seemed scarcely equal to the enormous weights with which they were frequently loaded. These baskets were, however, never great favorites, although their difference of price caused them to be frequently well filled."

In the following cut we have the picture of a stage-coach of the time of Hogarth, or at least a similar one to that represented in his print of "The Country Inn Yard," which he so ludicrously depicts. Instead of two, it would seem to require at least four horses to move

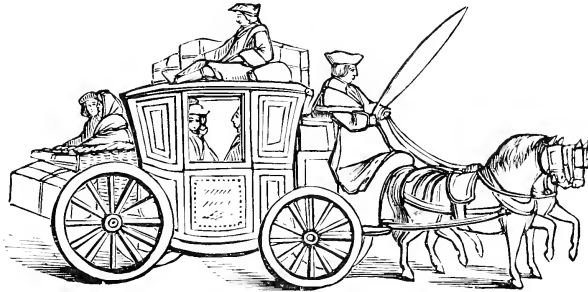

ENGLISH STAGE-COACH, 1755.

it with success. The model is far behind, in symmetry, that of the pleasure-carriages of that period. The driver seems to be cramped up in an illy constructed boot, and the low-fare passenger with the baggage on the roof sets all hopes of comfortable traveling at defiance. The twain *bundled* in the box (basket) with the trunks, in rear of the body, are, if possible, still more inconveniently placed; nor are the inside passengers much better off. The wheels of these old stage-coaches were large, massive, ill-formed, and usually of a red color, and the three horses sometimes affixed to the machine — the foremost

of which was helped onward by carrying a huge, long-legged elf of a postilion, dressed in a cocked hat, with a large green and gold riding-coat — were all so far parted from it by the great length of their traces that it was with no little difficulty that the poor animals dragged their unwieldy burden along the road. It groaned and creaked at every fresh tug which they gave it, as a ship rocking or beating up through a heavy sea strains all her timbers with a low, moaning sound as she drives over the contending waves.¹

It was some time before stage-coach traveling was performed at night, the practice of which probably suggested the necessity of a guard, because of dangers from robbers, who frequently left their victims apparently dead in securing their ill-gotten gains.

There are some very gorgeous ceremonies peculiar to European cities, from which happily our country is free. Among these is the Lord Mayor's Show, annually made on the ninth day of November, when a new magistrate is inducted into office. This now useless expenditure of money has grown out of a fondness for pageantry among the gayer classes in earlier times. When King John in 1215 first granted a mayor to the city of London, it was stipulated that the man elected to the office, before entering thereon, then a lifelong tenure, should be presented to the king or his justice at Westminster for approval. This appearance was made by a party on horseback, the water procession in barges not having been added until 1436. Since that time it has been no uncommon sight to find "Neptune," in his chariot on the Thames, addressing the candidate previous to his appearance at Westminster. Occasionally a chariot was seen in the procession, but no Lord Mayor appeared in a coach until 1712. A coach was built for this special purpose in 1757, at a cost of £1,057 3s.

¹ The first post-chaise built in England is said to have been constructed in Queen Street, Lincoln's Inn, in a building where the same business is, or was until recently, carried on. It had but two wheels, and was open in front. One writer describes it as having very much the appearance of a bathing-tub. We learn from the *Historical and Descriptive Account of the British Post Office*, recently published in England, that one John Palmer was the first to advocate carrying letters in what has since been called mail-coaches. This was in 1783, and under much opposition from the post-office officials; but continued perseverance led to his final installation of comptroller-general of mail-coaches. Under his management receipts largely increased, and it is said that Palmer's coaches were so well guarded that they were never robbed. The transmission of the mails between Edinburgh and London was done by him in six hours less than it had previously ever been.

For some forty-five years previously this dignitary was provided with a coach from those in common use.

It appears from an entry in the "British Chronicle" of Wednesday, the 9th of November, 1757, that this coach was built "by subscriptions of £60 each from the several aldermen then under the chair, and the aldermen entered into an agreement that every gentleman thereafter elected alderman should on his admission subscribe £60 towards the expense of building the coach, and when elected mayor £190, which £100 was to be allowed him for ornamenting and beautifying the same." It is thus described:—

The under-carriage ("carriage-part") has a double perch terminating in dolphins' heads. Over the back axle-tree is an open frame-work, to which the braces supporting the body are attached; the ends of which frame-work are ornamented with two griffins, and in the center is the shield of the city arms, supported by effigies of Commerce and Plenty. Two marine figures, supporting a large scallop-shell, supply a foot-board for the driver. The massive wheels, as well as some other portions of the under-carriage, are richly carved, painted red, and gilded. The bosses covering the end of the hub are very elaborate, and likewise gilded.

The body of this coach is "hung off" upon four thick leather braces, attached to as many parts of frame-work, fastened with large brass buckles, ornamented with the city arms. The lower front panel—supposed to have been painted by Cipriani—represents Faith beside an altar, supporting Charity, with Hope directing the spectator's attention towards a picture of St. Paul's; the lower back panel, Genius of the City, seated, into whose lap Riches and Plenty are pouring money and fruit, a ship being represented in the background, Merchandise in front; the upper back panel, Genius of the City, accompanied by Neptune, receiving Trade and Commerce. This same Genius of the City makes her appearance on both door panels: on the right, having in her hands the sword and scepter, Fame presents her with a Lord Mayor in the act of being crowned, the accessories being a table, on which are grouped the sword, mace, and a cap of maintenance; in a small lower panel, the staff of Mercury and a cornucopia. On the left, this Genius stands with her right hand resting on a civic shield, with Mars directing his spear to a scroll held by Truth, on which we read the name of "Henry Fitzalwin, 1189," reputed as being the first

mayor, the Tower of London with shipping forming a background; in the small lower panel, the city sword and scales of justice. One side panel represents Truth holding a mirror; another, Temperance with a bridle; a third, Justice holding the scales; a fourth, Fortitude. At the lower angles of the doors, as well as those of the front and back panels, are emblazoned the arms of the city and those of the ruling Lord Mayor. On the roof are eight vases. The central figure—what remains of it—is covered with the arms of the city, from which, as the base, scroll-work trails over the roof in every direction.

Plate-glass serves for the windows. Over the doors are Phrygian caps, with wings surrounded with scroll-work; between the upper and lower panels, helmets, spears, and flags. Other diminutive figures are emblematical of the four quarters of the globe. Over the back panel are the serpent and dove, representing wisdom and innocence.

The student curious in such matters will find a very full history of these Lord Mayor's Shows in Knight's "London," which it appears varied with the name or business character of the incumbent, a punning allusion to which frequently supplied a "central idea" for gratification, as when, in 1591, William Web was inaugurated, "in the hinder part of the pageant did sit a child representing Nature, holding in her hand a distaff, and *spinning a web*, which passeth through the hand of Fortune, and is wheeled up by Time."

From a work published in 1768 we extract the following: "There is of late an admirable commodiousness both for men and women of better quality to travel from London to almost any town in England, and to almost all the great villages near this great city, and that is by stage-coaches, wherein we may be transported to any place, sheltered from foul ways; and this not only at a low price, at about a shilling for every five miles, but with such speed as that the posts in some foreign countries make not more miles in a day; for the stage-coaches called flying coaches make fifty or sixty miles in a day, or from London to Oxford or Cambridge; sometimes seventy or eighty or one hundred miles, as to Southampton, Bury, and Norwich."¹

The brouette, a French invention, previously noticed on page 230, was introduced into England about this time. These were sometimes known as *vinaigrettes* (sour), and not improperly so called by the

¹ *Magna Brit. Notitie.*

sedan chairmen of the day, who, finding their business injured by this Continental interloper, had their tempers very much *soured* at the loss of patronage in consequence. Indeed, the owners of sedans tried their best to have them prohibited, and for some time with success. It took some years to overcome the prejudice raised against them in England before they were once more seen on the street, coming into general use in 1770. As made in England they looked very much like a sedan-chair supplied with wheels, the movement of which was still restricted to manual labor, as shown in the illustration. Two legs framed into the shafts serve to support the machine when at rest. We learn that at the present day, in one or two London parishes, similar contrivances are still employed for the removal of sick paupers, for which purpose they seem well adapted.

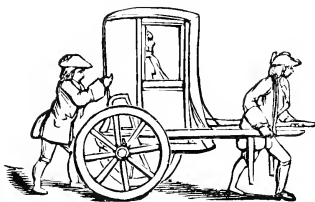

ENGLISH BROUETTE.

While the war was being prosecuted by the owners of the sedans against brouettes, there one day appeared a novelty, which set all London in an agitation. This was a *high-flier* in the form of a phaeton, of which an illustration is given below. It soon became popular

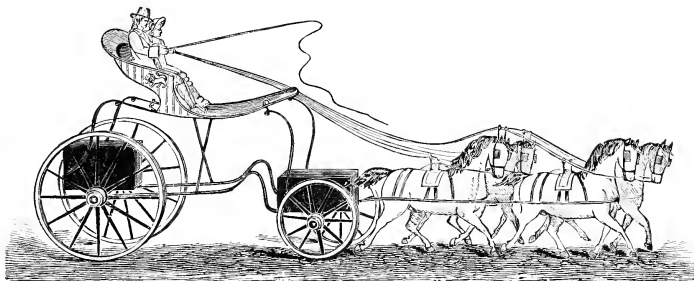

ENGLISH HIGH-FLIER PHAETON.

among the sporting young men of that day, and continued so for many years. Adams observes that "to sit in such a seat, when the horses were going at much speed, would require as much skill as is evinced by a rope-dancer at a theater. None but an extremely robust constitution could stand the violent jolting of such a vehicle over the stones

of a paved road." Fairholt, in the "Art Journal," thus alludes to these phaetons: "The insecurity of the springs, the ugly box in front, and the unsightly open one for servants behind, the tottering danger of the seat-holders, who reached their elevation by means of a ladder, which was in some instances permanently fixed to the side, all rendered

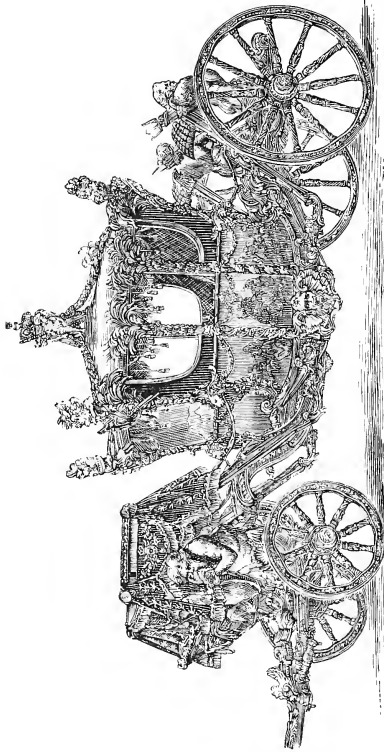

STATE COACH OF ENGLAND, 1762.

it inconvenient and dangerous. It was still received with much favor among 'the bucks and bloods' who loved display and thought the risk of a neck nothing in comparison with a dashing equipage, calculated to make the groundlings stare. It came into fashion under the highest auspices, and was a favorite driving carriage of the Prince of Wales, afterwards George IV. When the novelty of the thing had ceased, and commonsense returned, it was gradually lowered, until the phaeton assumed a convenient form like that we now see.'

George III two years afterwards (1762) ordered a coach built after a design by Sir William Chambers, weighing about four tons, and, as we heard an Englishman say when viewing it on exhibition at South Kensington, "enough to make one sea-sick to ride in it." The costs were: for the coach-maker, £1,763 15s. 6d.; for the carver, £2,500; gilder, £933 14s.; painter, £315; laceman, £737 10s. 7d.; chaser, £665 4s. 6d.; harness-maker, £385 15s.; mercer, £202 5s. 10½d.; bit-maker, £99

9s. 6d.; milliner, £31 3s. 4d.; saddler, £10 6s. 6d.; woolen draper, £4 2s. 6d.; cover-maker, £3 9s. 6d.; total, £7,662 4s. 3½d., or about \$36,778.¹ Length, twenty-four feet; width, eight feet three inches; height, twelve feet; pole, twelve feet long. Of it a rhymer has said:—

“Yield, ye triumphal chariots, yield the prize!
 Nor boast your feats, ye fabled deities!
 Though called a coach, behold a palace move
 Grander than any ye can shew above.
 Even Sol himself, suspended on his way,
 Stoops to behold a brighter car by day,
 Dreads that another Phaeton has driven
 His blazing carriage through the road of heaven,
 While Jove, still mindful of Promethean skill,
 Fears that his throne has left the Olympian hill;
 Neptune, alarmed to see the Tritons here,
 Thinks an usurper of his ocean near;
 Mars with surprise beholds the warlike car,
 And sees, or thinks he sees, a rival god of war;
 Well may they fear, united on his throne,
 To see their separate powers in George alone.”

The following picture, *painted* by an Englishman, must at least amuse the reader: “The preparation of the royal equipage for a grand state occasion is a real sight. The tails of all the royal studs being properly adjusted (why should not horses of fashion, like their mistresses, wear false hair?), they are with some little trouble harnessed, for many of them are entire animals, and their mode of life inclines them to wax fat and kick against the pricks. And now comes the important operation of mounting the state coachman on his box. This is by no means done with a spring and a jump; on the contrary, it is a solemn and laborious affair. There must be no haste, no jesting; otherwise the magnificent posy in his buttonhole will be displaced, and all the powder shaken out of the prim curls of his periwig. A ladder is procured, and he mounts to his seat at the top of the large vehicle, and there he sits, a perfect ‘bright poker’ of a coachman, the postilions being really in command of the animals, in conjunction with the state-grooms, who walk beside them.”

Another Englishman thus describes a modern state show: “There

¹ The original bill amounted to £8,000, but was reduced to the amount mentioned in the text, after taxation.

was curiosity, decorum, respectful welcome everywhere, but no popular enthusiasm. . . . Probably the spectators hardly discriminated the royal carriage from the others, missing the gorgeous old gilt, gilt-gingerbread shandrydan commonly used on such occasions; and then the Queen sat so far back that she was hardly visible, except to those who happened to be close to the carriage windows. . . . However, there were the orthodox six pair of cream-colored horses attached to the royal carriage, and the same number to six other vehicles. The color, you know, is sacred to British and Hanoverian majesty. When Bonaparte the First gobbled up the latter, he also annexed all the cream-colors he could find in the stables to use at his own coronation, — a practical joke which induced old George III thenceforth to sport only black horses." It has been estimated that the stud from which eight horses are annually selected for the two hours' work required, costs the English nation something like £1,000 an hour!

The "flying machines" of 1765 are thus described by M. Crosley, a French traveler, who rode in one from Dover to London in that year. He says, "The great multitude of passengers with which Dover was crowded afforded a reason for dispensing with a law of the police by which public carriages in England are forbidden to travel on a Sunday. I myself set out on Sunday, with seven more passengers, in two carriages called 'flying machines.' These vehicles, which were drawn by six horses, go twenty-eight leagues in a day, from Dover to London, for a single guinea. Servants are entitled to a place for half that money, either behind the coach or upon the box, which has three places. The coachmen, who were changed every time with our horses, were lusty, well-made men, dressed in good cloth. When they set off, or were for animating their horses, I heard a sort of periodical noise, resembling that of a stick striking against the nave of the fore-wheel. I have since discovered that it is customary with the English coachmen to give their horses the signal for setting off by making this noise, and by beating their stools with their feet in cadence; they likewise use the same signal to make them mend their pace. The coach-whip, which is nothing else but a long piece of whalebone covered with hair, and with a small cord at the end of it, is no more in their hands than the fan is in winter in the hands of a lady, — it only serves them to make a show, as their horses scarce ever feel it."

In a preceding passage we have intimated that vehicles were invented

under various names. One of the results of later improvements was the *barouche*, an engraving of which is given below, the upper portion of which was so contrived that it could be turned down at the pleasure of the passengers. This vehicle, pronounced light in its day, would now be called a clumsy affair. Our picture is copied from a print intended to ridicule the follies of the year 1767, among which riding in carriages was classed, as a modern writer observes, "after the ordinary fashion of moralists, who generally contrive to be on the safe side by condemning everything new." This



ENGLISH BAROUCHE, 1767.

party picture was designed to represent "British nobility *disguised*." The state of the pavements, until the middle of the last century, gave but poor encouragement to the building of light carriages, and the fears of an inexperienced people put a check upon the use of pleasure-carriages; but from that time we find them coming rapidly into use.

In this year a Mr. Young "found the lanes so narrow that not a mouse could pass a carriage, and ruts of incredible depth; wagons stuck fast, until a line of them were in the same predicament, and required twenty or thirty horses to be fastened together to each to draw them out one by one." Malcolm, in his "Anecdotes of the Manners and Customs of London," tells us that "those honest city tradesmen and others who so lovingly carry their wives and mistresses to the neighboring villages in chaises to regale them on a Sunday, are seldom sensible of the great inconveniences and dangers they are exposed to; for besides the common accidents of the road, there is a set of regular rogues kept constantly in pay to incommode them in their passage, and these are the drivers of what are called waiting-jobs, and other traveling hackney-coaches, with sets of horses, who are commissioned by their masters to annoy, sink, and destroy all the single and double horse chaises they can conveniently meet or overtake in their way, without regard to the lives or limbs of the persons who travel in

them. What havoc these industrious sons of blood and wounds have made within twenty miles of London, in the compass of a summer's season, is best known to the articles of accidents in the newspapers, the miserable shrieks of women and children not being sufficient to deter the villains from what they call their duty to their masters; for, besides their daily or weekly wages, they have an extraordinary stated allowance for every chaise they can reverse, ditch, or *bring by the road*, as the term or phrase is. I am credibly informed that many of the coachmen and postilions belonging to the gentry are seduced by the masters of traveling-coaches to involve themselves in the guilt of this monstrous iniquity, and have certain fees for dismounting persons on single horses and overturning chaises, when it shall suit with their convenience to do it with safety, that is, within the verge of the law; and in case of an action of indictment, if the master or mistress will not stand by their servant, and believe the mischief was purely accidental, the offender is then defended by a general contribution from all the stage-coach masters within the bill of mortality." This is a very sad "tale of the day," scarcely credited by those living in later times.

It is stated that a gentleman of the name of Moore in 1770 invented a kind of coach which was, in truth, an embryo omnibus, and is described as having been a common coach reversed, containing six passengers, swung between two large wheels nine feet six inches in diameter; and with the driver perched upon the roof, and one horse in shafts, is stated to have carried seven persons with ease from Cheapside to the summit of Ludgate Hill.

The "flying coach" previously alluded to under the name of "a flying machine," is said, in the Diary of Anthony Wood, to have completed the journey between Oxford and London in thirteen hours, which is certain evidence that the improved roads and improved vehicles were all contributing to render traveling more expeditious and pleasant. Still there were those whose prejudices or interests concocted serious charges against their use. One was, that they were very liable to overturn, and endanger the life of the passenger. In the "Gentleman's Magazine" for 1771, we find a correspondent stating the cause of these accidents and suggesting remedies. He says that the bodies are suspended too high from the ground, and too heavily laden with passengers on the roof. He wishes that carrying passengers on the top could be strictly forbidden, but is apprehensive that,

though it were, the ambition of coach-owners would raise the inside fares so high that it would prevent many from riding in coaches. Another cause is ascribed to the excessive roundness of turnpike roads, which was frequently so great that one coach could not pass another without great danger of upsetting. This "reformer" suggests, as one remedy, that it should be made imperative on coach proprietors to have their axle-trees made longer, so as to track five feet eight inches instead of four feet eight. This improvement would not only render the coach less liable to overturn, but allow of the body being made larger, so as to contain six passengers. This would lessen the price of an inside seat, and traveling, in consequence, become much cheaper. What effect our speculator — for he evidently was not a coach-maker — may have had, may be inferred from the following information, derived from the "Annual Register" for 1775, where we are told that "the stage-coaches of the day generally drive with eight inside and often ten outside passengers each." It is there stated that there were upwards of four hundred of the coaches included in the terms flies, machines, and diligences, "and of other four-wheeled carriages seventeen thousand."

In the year 1779, Alexander Cummings, Esq., F. R. S., wrote a paper on the comparative merits of cylindrical and conical wheels, a subject which in our day seems unworthy the thought bestowed upon it. Any mechanic of the least practical observation would at a glance pronounce a conical wheel simply an absurdity, and yet such found strenuous advocates for their superiority over all others in earlier times. He says: "The cylindrical wheel, having all its parts of equal diameter, will, in rolling on its rim, *have an equal velocity at every part of its circumference, and necessarily advance in a straight line,*" with the least possible resistance, leveling the substance on which it rolls.

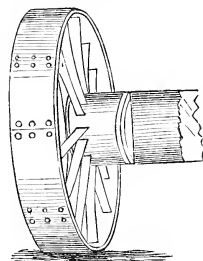

CYLINDRICAL WHEEL.

"When wheels with cylindrical rims are connected by an axis, the tendency of each being to advance in a straight line, they proceed in this connected state with the same harmony and unity of consent that exist in the parts of the same cylinder with the same facility of motion so favorable to the horse, and with all other properties that have been

stated as favorable to the roads, *there is no more friction or resistance in this connected state of the pair of wheels* than is applied to the same, and *than if each rolled separately or unconnectedly.*"

Per contra: "But as *conical rims* have been universally preferred for a series of years, it is natural to suppose that there were obvious reasons for such preference; let us then endeavor to investigate the properties that must necessarily arise from the shape of the cone, and see from them how far the *consequent effects* can justify the preference so long given to the conical rim."

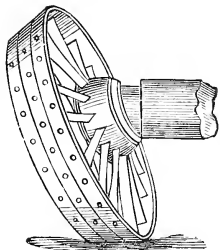

CONED WHEEL.

in order to show its absurdity.

We have not space to enter fully into the mechanical operations of a coned wheel; suffice it here to say that a small expenditure of judgment will satisfy any one that a wheel with the hub rubbing and cutting into an axle-tree at the shoulder, as is here shown, must not only prove detrimental to the axle-tree, but require more strength to move it, indeed tax the horse beyond endurance. Such "a monstrosity" is beneath the contempt of modern mechanism, and is only introduced here

The next engraving represents the coach of the Lord Chancellor of

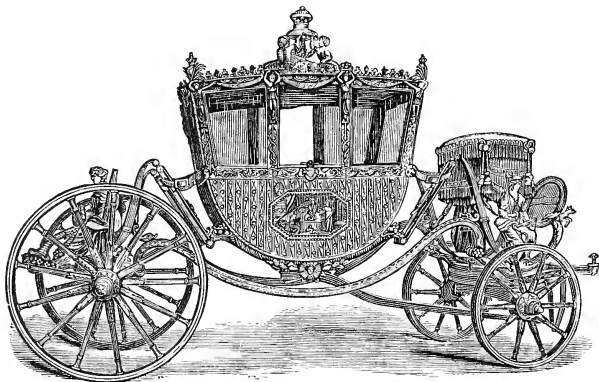

COACH OF THE LORD CHANCELLOR OF IRELAND.

Ireland, built in 1780, and lately shown in the South Kensington collection. The allegorical decorations on the panels are by W. Hamilton, B. A. Some of the improvements made in carriages during the eighteen years since the English state coach was built are observable in this, although, in all probability, it is more in accordance with the Lord Chancellor's fancy than the fashion then in vogue. Like most vehicles contrived for the state, it may be said of it that "it is more for ornament than use."

The year 1784 is remarkable for the introduction of umbrellas into London from Paris, and the decided opposition they met with from the chair and hackney men, as being detrimental to their business, regardless as usual of the public welfare.

John Collinge, a London coach-maker, in 1792 invented a complex but valuable axle and box, so constructed that it will run three months without oiling, and is almost noiseless. The greatest drawback is the difficulty of supplying parts when such are lost, as we have found out by experience. For this reason the American half-patents and other inventions have been substituted.

In the latter part of the eighteenth century much attention was given to road-making in England, and one objection which Cummings brought against the use of conical wheels was that they injured the roads. To repair — or at least to prevent — such damage we shall suppose Robert Bealson, Esq., in 1796 invented "a simple contrivance for preventing the wheels of carriages making ruts in roads." He tells us that, "although several machines have been invented for facilitating the *repair* of

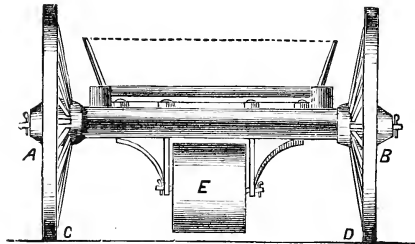

ROAD PROTECTOR, 1796.

roads, and filling up of ruts made by carriages, yet no method has ever been proposed, so far as I know, to *prevent* the wheels of carriages *making* ruts." Thinking it "easier to prevent an evil than to cure it afterwards," he gives us what he calls "a road protector." In the diagram, *A* and *B* are the wheels; *C*, *D*, supposed level of the road; *E*, the broad roller, one and a half inches from the ground,

only to come into service when the wheels sink below the surface of the ground. Mr. Bealson fairly exults under the idea that, "by keeping the protection a little higher than the lower level of the wheels, it is evident that on good hard roads or streets the wheels will always bear the weight of the load, nor can they make any ruts, or sink into old ones, however deep they may be, while the middle of the road remains firm, for the protector will roll upon the middle, which will certainly be a much easier draft for the horses than if the wheels were in deep ruts."

The following year, Henry Overend, of Bristol, invented "a wheel-carriage, or machine, which may be used as a wagon, cart, or dray, in a more perfect or expeditious manner and with fewer horses than usually and heretofore done," assuring us that the engraving, a copy of which is given below, is a correct drawing of his machine. Mr. Overend says his machine hung about "a foot from the ground, but that it

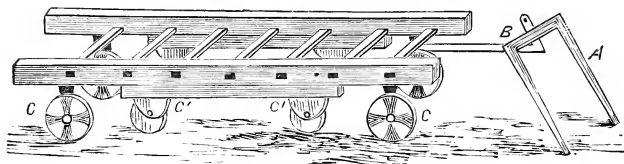

CART AND WAGON COMBINED, 1797.

could be made either higher or lower, as the occasion may require, upon the same principle and proportion."

In the diagram, *A* denotes the shafts, which may be shifted to either end of the machine; *B*, iron receiver for the shafts; *C*, *C*, *C*, *C*, the iron wheels; *C'*, *C'*, patent caster-wheels fixed on the center of the bars of the machine. How such a machine could be "moved in an expeditious manner" would puzzle any modern coach-maker. This machine is confessedly the invention of "a gentleman," and therefore a failure.

Notwithstanding these "eccentricities," the invention of *gentlemen*, carriage-making made rapid strides during the last quarter of the eighteenth and the first quarter of the nineteenth century, as appears from W. Felton's "Treatise on Carriages and Harness," the first volume of which appeared in 1794, and the second in 1795. In his introductory remarks he says, "The art of coach-making within this last

half-century has arrived to a very high degree of perfection, with respect both to the beauty, strength, and elegance of the machine. The consequence has been an increasing demand for that comfortable conveyance, which, besides its common utility, has now in the higher circles of life become a distinguishing mark of the taste and rank of the proprietor." He, however, complains because "more than a third part of the master coach-builders were in fact only harness-makers, whose judgment in the construction of a carriage can go little further than that of a shoemaker; yet these *professors*, aided and supported by the coach-makers, have always opposed, and still continue to oppose, every other tradesman concerned in the manufacture of the principal materials of which a carriage is composed, such as wheelwrights, smiths, painters, carvers, joiners, etc., either of whose judgment must far exceed that of harness-makers, and many of whom possess a knowledge little inferior to the professed builder himself. But thus united, they strenuously oppose every new adventurer in the trade, though ever so well qualified, if not bred a harness or a coach maker, and connected with them in this association. They (the associators) have been pleased to dignify themselves with the title of *Brights*, and to bestow upon their rivals the opprobrious epithet of *Blacks*. This conduct has an evident tendency to a monopoly, and of consequence is a discouragement to the ingenious and enterprising tradesman, whose talents might otherwise raise him to eminence in his profession."

A custom still in practice, which on the score of honesty ought to have been abolished long ago, prevailed in Felton's time. He says, "A practice has been introduced, and a long time continued, that the gentleman of the whip receive *douceurs* from the tradesmen employed in building or repairing of carriages, no doubt with the original intention of encouraging the coachman to take good care of the carriage and preserve his interest with the employer. It is very likely the zeal and activity of the coachman will in a great degree be proportionate to the encouragement given him. Very extravagant expectations are formed by many, which, if not complied with, are sure to draw the resentment of the disappointed coachman upon the tradesman, and, if complied with, he has no other method of reimbursing himself for this very unfair transaction than by charging an exorbitant price for his workmanship; so that ultimately his employer suffers a manifest injury.

If the coachman be honest, attentive to his master's interest, and a tolerable judge of his business, he will discover that *any* repair is necessary, and in some measure to what extent that repair ought to be carried; but if swayed by sinister motives, and the tradesman should happen to be of the same complexion, a wide field opens for collusion between the two, and *the proprietor is sure to be imposed upon.*"

At the period of which we write, the S-spring, the original of the C-spring, had in various forms come into practical use. This will be manifest as we progress with our history. In the accompanying illustration we give the

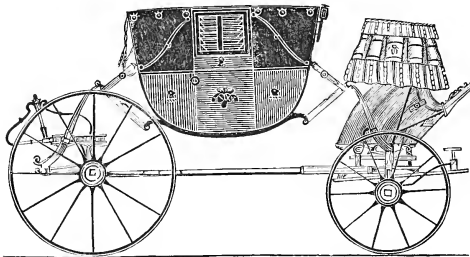

TOWN COACH, 1796.

reader what Felton calls a "neat ornamented, or *town coach*," which in his day sold for £190, or about \$912. This was hung upon S-springs, but we shall also find in other carriages the scroll, the

worm, the French horn, the double and single elbow, and the grass-hopper springs, each accommodated to the position for which it was designed. A set of springs then cost £3 18s., or about \$19. The singularly constructed box under the driver's seat is known as the "Salisbury boot," and the trimming of the seat is called the "hammer-cloth." Instead of glass, we find the doors supplied with blinds, and the footman's rack much like those already introduced in previous examples. The carriage for the first time exhibits a lamp, footmen-holders, etc.

The *traveling coach* of the latter years of the eighteenth century is shown in the next engraving. As these were principally intended for Continental journeys, strength and convenience were first to be considered, and plain, strong-built crane-neck carriages preferred, since "the roads on the Continent are very rough, and in the towns very narrow; and as there is not much opportunity for cleaning or mending on the way, the plainer and the stronger they are built, the better for the purpose." The great expense of these carriages was chiefly owing to

the many conveniences required for the passenger's luggage in that age. Felton's detailed description may prove interesting: "The *carriage* is a crane-neck; strong straked wheels [tire in pieces]; patent anti-attrition axles and boxes; a raised hind end, with short plain blocks; a common coach-box with a traveling seat; a platform budget before, with a large trunk within it, and inside straps and laths to ditto; a trunk behind with ditto, and two leather belts; a chain-belt for security, and an oil cover

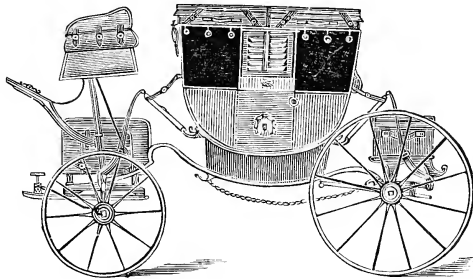

TRAVELING COACH, 1796.

for the trunk; the springs covered; a drag-staff [a short pole, or leg, let down at the hinder part of the coach in *ascending* a hill, while the horses rested]; a chain; and a tool budget for the coachman's convenience. The *body* plain, with a sword-case, lined with second [quality] cloth, and trimmed with a two-inch lace, and two and a half ditto for the holders; squabs, or sleeping-cushions, faced with silk; venetian blinds; seat-boxes; Wilton carpet; double-folding steps; the plating with composition metal; a five-eighths-of-an-inch molding all around the middle and roof, up the corner-pillars and side of the doors; a set of circles for head-plates; a pair of sword-case frames; a well at the bottom; two imperials for the roof; the *painting*, varnishing, etc., plain; mantles, with ciphers on the door-panels; crests on the stiles; main and check braces, with buckles, and French pole-pieces." The "loop-irons," seen in the two last engravings, are singularly at variance with the preconceived ideas of modern coach-building.

For show on certain occasions, a *crane-neck coach*, with considerable artistic taste, was built, a drawing of which is given on next page. Here a profusion of carved ornaments and figures in gilt, with beautiful paintings, decorate the outside; rich velvet linings and silk trimmings the inside. This coach was built on the same principle as the state carriages, such as in that day were shipped to the East and West Indies, "it being made very airy, with side and end lights or

windows; the kind of carriages used chiefly in those places are crane-necked, but are built much lighter than what is necessary for

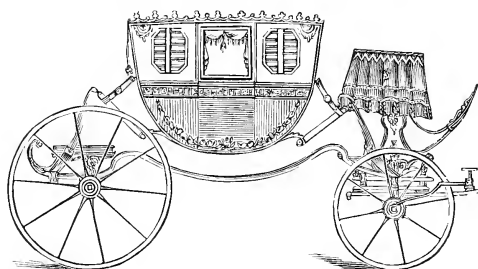

CRANE-NECK COACH, 1796.

this country [England], as the horses not being so strong, and the roads of soft, sandy soil, a heavy carriage would sink therein, and be obstructed by its weight."

The next carriage is known as the *landau*.

This differs but little from the coach, except that the top may be thrown down at pleasure, affording air and prospect in fine weather. Felton pronounces them "the most convenient carriages of any, as so many persons may be accommodated with the pleasure of an open and a close carriage in one, without the care of driving, as in other open carriages, or the expense and incumbrance of keeping two, and the expense for duty saved thereby, are advantages worth the notice of those who wish to be thus accommodated." But it seems "the care of driving in other open carriages" prevented the general use of *landaus* in former days as

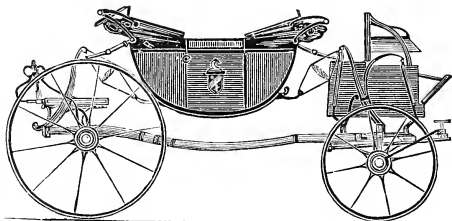

ENGLISH LANDAU, 1796.

in our own; and besides, the cost is a no inconsiderable sum for the common people to be at, — no less than £190. For country use in summer jaunts, these carriages have always been popular in Europe.

For the use of a fashionable and exclusive class of customers, a *vis-à-vis*, or *sociable*, was built, and finished in a superior manner to the generality of carriages, and somewhat lighter in the body than the common coach, at much less expense. These *sociables* were originally intended for two passengers, who sat facing each other, — hence the

name, "vis-à-vis" (face to face); and, being narrow, were proportionably warmer, and the passengers not so easily tossed about.

The *post-chaise* was another variation from the coach model, designed for expeditious traveling, the draft of which was not impeded with unnecessary and cumbersome weight, but made light and plain. The absurd custom of the driver, in riding the near horse in traveling, was a long time practiced, although it was evidently the destruction of a great many horses; "for," says a writer of the times, "if a man is a sufficient burden for a horse to travel with, to impose also an equal share of the draft of a carriage, with his yoked companion, must soon fatigue him and impede the traveling thereby, unless the poor animal is scourged to exertion beyond his natural strength to keep pace with the other horse; any simple contrivance on the carriage for the driver to sit in would lessen the fatigue, both to man and horse, and be more likely to promote speed." These post-chaises, in the absence of facilities for travel enjoyed by us, were found very convenient, and were kept for public hire, as well as for private use, by such as were able to stand the expense. *Posting* by public conveyance submitted the traveler to some inconveniences, such as the trouble of changing his luggage to another vehicle at the end of a post. This could only be avoided where an individual was the owner of his own chaise. The expense, whether by public or by private conveyance, was about the same.

The next engraving represents a *town chariot* of the close of the past century, which was considered a very genteel carriage. It was far more convenient than the coach, being lighter and more airy. These vehicles complete seventy-five years ago cost about one thousand dollars. That the reader may have some knowledge of the details, we reproduce them from Felton's work: "The carriage [or running gear] is a perch of the bent or crooked form, with iron-plated sides; a whole wheel-front; an iron coach-box on a

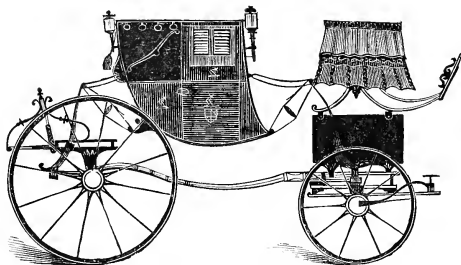

TOWN CHARIOT.

square trunk-boot, raised on neat carved blocks; a raised hind-end, with neat carved blocks; a footman cushion, with plated moldings to the frames, and carved high standards; hooped tire wheels, with molded felloes and common axles and boxes. The *body*, with round sides, a sword-case back, contracted door-lights, lined with second cloth, trimmed with three-and-a-half-inch lace, swinging holders, a pair of silk squabs, plate glasses, with laced glass frames, and silk spring-curtains; venetian blinds, sliding seat boxes, a Wilton carpet, and double folding steps. The *plating* with silver, a small three-eighths-inch molding, or quill-bead, in double rows around the side panels, and in single row round the front and door lights; a half-inch molding all around the middle and roof, up the corner-pillars and sides of the door, and along the bottom-sides; four silver scroll ornaments; an octagon, and a pair of sword-case frames; a pair of plated thick joints, with barrel props and caps for them; eight silver crest head-plates, with silver circles; a set of case-plated metal wheel-hoops; a plated pole-hook and check-brace rings, and five Italian full-plated lamps. The *hammer-cloth* of livery, trimmed with a two-and-a-half inch, a bottom row of one-inch, and a middle row of four-inch lace, one bottom row of seven-inch ornamented fringe; four three-and-a-half-inch double lace footmen-holders. The *painting* 'picked out' two colors; the panels polished; the arms on the doors, and crests on the quarters and stiles; the main and check braces with whole buckles; and a set of worm springs, with French pole pieces."

The *landaulet* was another very convenient carriage for a small family not able to keep more than one at a time. The strongest

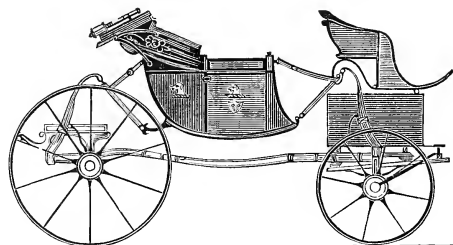

LANDAULET, 1796.

objection to these, and indeed to all heavy carriages where the top is thrown down, is that the driver's seat obstructs the view in front, and deprives the passenger of much of the pleasure he might enjoy were it otherwise.

Sometimes these demi-landaus, as they were occasionally called, car-

ried a concealed seat in the coach-box (the box seen under the seat), put in its place, or taken off when required, at the option of the owner. The modern mechanic will not fail to notice the objectionable manner in which the lamp is placed when the top is down, and the strange taste shown in the formation of the "body-loop."

The *post-chaise*, another carriage much used by Englishmen in traveling on the Continent, would be well represented by removing the front quarter from the town coach on page 336, and supplying a standing front pillar to it like the one on page 339.

The *chariots*, of which we give an illustration, were generally finished handsomer and richer than the coaches of Felton's day, and formed a prominent object in all showy processions. The elegance in these vehicles consisted principally in the carved and gilt ornaments to the under-carriage, the fanciful paintings on the panels of the body, and the inside linings of silk and velvet.

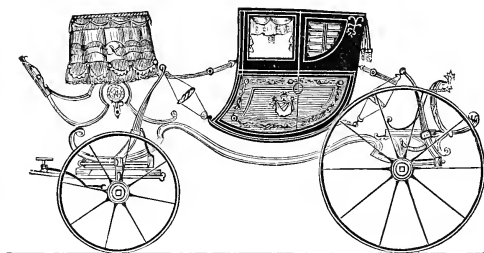

CHARIOT, 1796.

Felton tells us seventy-five years ago, that "A *sulky* is a light carriage, built exactly in the form of a post-chaise, chariot, or demi-landau, but, like the vis-à-vis, is contracted on the seat, so that only one person can sit thereon, and is called a *sulky*,¹ from the proprietor's desire of riding alone." These vehicles were lighter in draft than many others, being so narrow on the seat that "the passenger sits more warm, and is less incommoded by the jolting of the carriage."

The *phaeton* variety of carriages had been in use previous to the close of the eighteenth century, and "deservedly regarded as the most pleasant sort of carriage in use, as they contribute more than any other to health, amusement, and fashion, with the superior advantage of lightness over every other sort of four-wheeled carriage, and are much safer, and are more easy to ride in, than those of two wheels." Much

¹ The sulky of our day is quite a different affair from the one described by Felton, but its exclusive use by men has won for it the name of *selfish* from the ladies.

scope is given, in the construction, to fancy, and perhaps in no other class of carriages has so much taste been displayed. A very good representation of this class of vehicles is found in the first illustration on this page. They were hung very high, and might very appropriately be termed "high-fliers," as we have seen them called thirty years before. Our example was known as the *perch-high phaeton*, in contradistinction to the *crane-neck phaeton*; and although it did not present the same

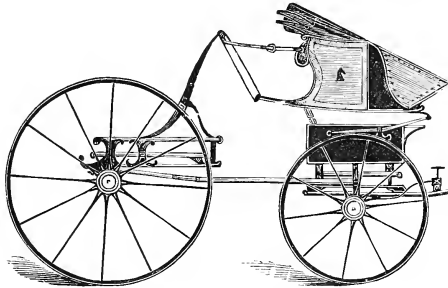

PHAETON, 1796.

facilities for traveling as this last, could be made much more substantial, — a matter of no small importance to travelers. The body is, in form, the original of the gig, and the type has been a long time followed out in England. The most striking peculiarity in this vehicle to a modern craftsman is the manner of hanging up the body, the load resting almost entirely upon the forward wheels. The tendency evidently was to make it draw heavier, and besides increased the danger of breaking the front axle-tree. To overcome these disadvantages, longer perches than ordinary were used, which gave them an unartistic appearance. This phaeton was generally used to a single horse. The cost of such a phaeton was £93, or \$450.

A fine example of a one-horse or *pony phaeton* is illustrated in the next picture. Felton's remarks in regard to phaetons generally are so sensible and practical that we may profitably reproduce them here: "A pair of ponies from twelve to thirteen hands high are about equal for draft with a horse

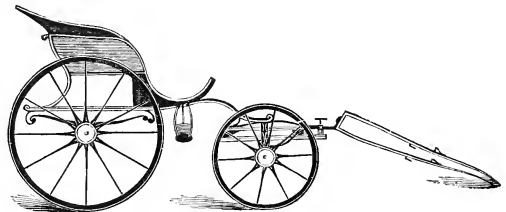

PONY PHAETON.

of fifteen, and a phaeton of the same weight is equally adapted for

either; excepting only that each should be built of a proportioned height for the advantage of both horse and driver. A low phaeton and a high horse are equally as absurd as a high phaeton and a low horse; yet timid and infirm people prefer low phaetons, — the infirm, because they are easy of access; and the timid, because they are more easy to escape from in time of danger, without considering that the danger often arises from not having a proper command of the horse when any accident occurs to startle him. Those phaetons are frequently designated for one horse or a pair of ponies, and sometimes for one or two horses alternately; a medium should then be observed in the building, that it be neither too high for the ponies nor too heavy for the one horse; a pole and shafts are then necessary, — the pole for the pair, as usual, and the shafts for the single horse.”

Another of the phaeton class was called a *pony-berlin phaeton*. The body — a half-paneled chaise body — was hung a ridiculous distance from the horse, on what was called a crane-neck, and being shaped from the wood unbent, was very liable to break. Judging from appearances, they were hard-riding contrivances. Another kind was hung on “grasshopper,” which has since assumed the shape of the C-spring, in connection with the common perch; and although it did not answer as well for short turning, was said to be “a safe, light, simple, and cheap four-wheeled phaeton,” — four qualities very desirable in vehicles at the present time, but not obtained in the one under examination, judging from the drawing made seventy-five years ago. They were, however, pronounced “perfectly safe,” — a decision it would be difficult to contradict, since they were made without stint of material. The cheapest phaetons cost £40, and the more costly about £70.

Another vehicle, just coming into use in 1796, was called the *shooting phaeton*, designed for the Nimrods of that day. Gigs had previously been used for hunting purposes, but two-wheeled vehicles were deemed more unsteady to shoot from than four-wheeled ones, and were therefore getting unpopular. The dogs were carried in a box-like contrivance, called a *well*, detached from and hanging under the body over the springs, back and front. These “dog-carts” cost about \$325.

Formerly the *sociable* or *vis-à-vis* was classed as belonging to the phaeton species, although sometimes built with two or three seats, capable of carrying six or nine passengers. These sociables were

designed expressly to meet the wants of pleasure-seekers in the public parks, and for occasional excursions with the family into the country. The body in this example is a simple combination of the different phaetons we have previously described, and at this distance of time seem odd enough. They frequently, when built, were made so as to allow of their being hung upon the carriage-parts of coaches, chariots, etc., after removing the bodies of such. This avoided the expense incurred by keeping two carriages, as the sociable body was only occasionally

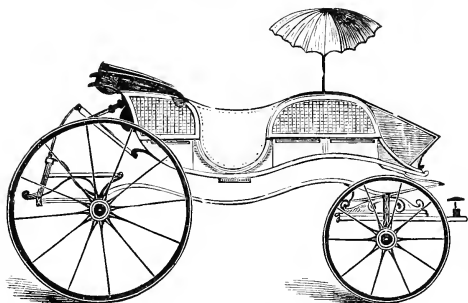

SOCIABLE.

required. This sociable was once known as "a three-tub-bottomed-shaped chaise," and we are assured by a contemporary author that "the body could be built very light and simple, although they carry many passengers; but as they are intended for country use only and in fine weather, they need not be more heavy than a common phaeton, and a great convenience for large families may be furnished at a little expense." These sociable bodies were a union of three other phaeton bodies, with drop-seat boxes to each and a sword-case to one, and all built on one large bottom formed to the shape of the crane-neck, and cost about the same as three single tub-bottom chaise bodies. The side quarters were frequently caned, instead of being paneled, and in such cases the rails only were lined and supplied with cushions and falls. The engraving presents us with the first example where an umbrella was employed, and is interesting in this respect. The space between the front and back seats was supplied with a leather flap, secured in its place to buttons. A folding draw-step assisted the passenger to mount the vehicle. In the front spring we have the rudiments of the later elliptical spring.

We now turn our attention to some of the two-wheeled vehicles of the age of which we write, nearly all being varieties of the chaise and curricule. The *curricule*, of which we give an engraving, was considered an improvement on a former vehicle bearing the same name. Felton

says of them, "They are certainly a superior kind of two-wheeled carriage, and from their novelty, and being generally used by persons of eminence, are on that account preferred as a more genteel kind of carriage than phaetons, though not possessing any advantage to be compared with them except in lightness, wherein they excel every other, having so great a power to so small a draft. They are built much stronger and heavier than what is necessary for one-horse chaises, and the larger they are the better they look, if not to an extreme. They are often made to be used with one or two horses, and are convenient

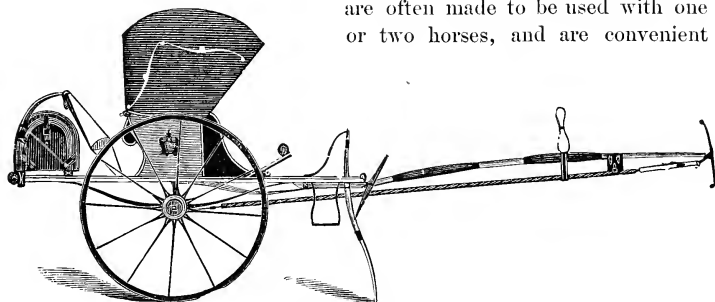

CURRICULE PROPER.

when made so for traveling; for if, by accident, one horse fail, the other may proceed with the carriage as with a one-horse chaise, having the harness also suitably contrived. It is only for occasional purposes that it can be recommended, as a proper-proportioned curricule for two horses is much too heavy to be frequently used with one."

These curricules of Italian origin (Latin *curriculus*) were of three sorts, as the curricule-gig or changeable curricule, the fixed or proper curricule, and the new-pattern curricule. The first was used either as a curricule or gig, and was light enough for a single horse. The proper curricule, of which the above engraving is a representation, were generally owned by "persons of high repute for fashion, and who are continually of themselves inventing some improvements, the variety of which would be too tedious to relate." When not in use a rest was let down to keep the pole from the ground in all cases. The draft was obtained by attaching a long rope from the axle-tree to the pole-crab. The cost of a new curricule of this kind was about £103, or about \$500. The new-pattern curricule differed from the others in the

fore end of the carriage-part only, where there are both shafts and pole for a double security, so that if the pole should break, the shafts may support the carriage.

The *new-pattern curricl*e was brought out in opposition to the others, with "a pretended improvement," the principal object of which was to do away with the pole, the sliding, and the props, by substituting two pairs of shafts, as in the engraving, in which the two horses were hitched as in a chaise, the shafts being semicircular, as in the diagram,

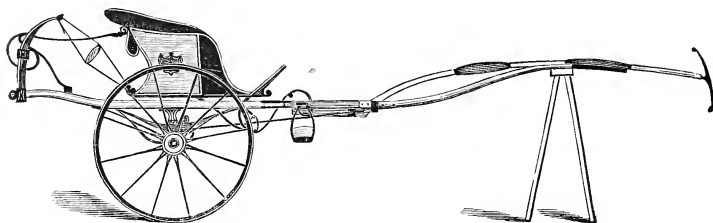

NEW-PATTERN CURRICLE.

and made to turn down "in the manner of a clasp-knife, to form a rest for the carriage instead of the prop; and also, if one of the horses should fall with him, without injury or incommoding the other horse further than stopping him, in consequence of the accident."

Forty years afterwards Adams observes, "The curricl is the only two-wheeled carriage used with more than one horse abreast, and therefore approaches nearest in mechanism to the antique classic car. In form, however, it is very different. The shape of the body is extremely unsightly. The hinder curve and the sword-case are positively ugly. The elbow and head are ungracefully formed, and the crooked front line and dashing-iron are in the worst possible taste. The lines of the carriage-frame work and under-spring are graceful, but the mode of hanging the body is unsightly and inconvenient. The step preserves the general formal character of the whole vehicle. The mode of attaching the horses is precisely that of the classic car, only more elegant. A pole is fixed to the square frame, and is suspended from a bright steel bar, resting in a fork on each horse's back. In spite of the ungraceful form of the vehicle, the effect of the whole was very good. A seat for a servant could be attached to the hind frame, if required. This carriage fatigues the horses much less than one with

four wheels [this is doubtful], on account of its superior lightness, but it has been wholly disused of late years, probably on account of the risk attached to it if the horses become restive. The whole of the security depends upon the strength of the pole, which serves as a lever to sustain the weight of the vehicle and passengers, as well as to guide it. It is not essentially necessary that the vehicle should be ugly in its form, for it affords facilities for constructing the most elegant of all vehicles."

Gigs, or one-horse chaises, were nearly all after the same pattern, being distinguished from each other by the terms *step-piece*, a *tub-bottom*, or a *chair-back gig*. The term "gig" proper was distinguished by hanging the body on braces from the spring, as in the next engraving. Curricles being then the most fashionable style of two-wheeled vehicles, the bodies of these were used in constructing, so as to imitate them as closely as possible when hung off, and these vehicles were then called

gig curricles, as seen here. They were designed to be used chiefly with one horse, al-

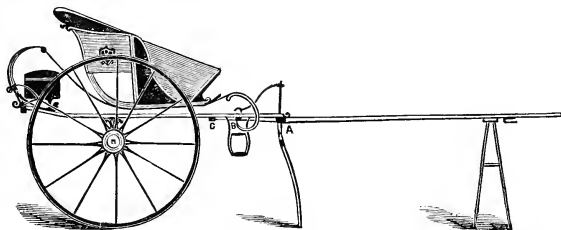

GIG CURRICLE.

though occasionally two were employed. They were made fully as light as the gig, and were found very convenient where the roads did not admit of two horses abreast. When two horses were used, three sockets, A, B, C, answered by which to secure the pole to the vehicle. This carriage has what is called a "trunk-boot," and C-springs behind and French-horn springs in front, the body resting on thorough-braces. The gig curri- cle was worth £54. The chair-back gig was hung from the "whip" or long-tail spring to a peculiarly shaped loop at the center of the back pillar by a loop-strap. The front of the body was mounted on single-elbow springs like those at the hind end of the sociable on page 344.

"Whiskies," Felton tells us, "are one-horse chaises of the lightest construction, with which the horses may travel with ease and expedi-

tion, and quickly pass other carriages on the road, for which they are called *whiskies*." These vehicles were built as light as possible, and hung off on the "cradle-spring" generally, this then being pronounced "easy riding." There were several kinds, such as the *caned whisky*, *half-paneled whisky*, *grasshopper-chaise whisky*, and the *whisky curriole*.

The caned whisky was considered the lightest and cheapest of all others, having a light, airy appearance for summer use, although not

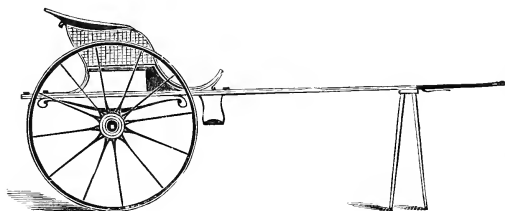

CANED WHISKY.

considered as strong as the paneled body, "but were less in the expense for painting and lining," and chiefly intended for country use in fair weather, conse-

quently they did not require tops, aprons, etc., which go to swell the expense and increase the weight of manufacture. These caned whiskies cost £24 10s., or about \$118.

The half-panel whisky was in form very similar to the caned one, with a sword-case, top, and sometimes with a place for a trunk, as in the curriole proper. These were on what were formerly known as "double-elbow springs," but in our day "cradle-springs." The dash, instead of being attached to the toe-board of the body, was fastened to the front-bar of the carriage. The step was a plain folding one.

The grasshopper-chaise whisky is represented in the next engraving, after an old pat-

tern, but Felton says "a very good one, as all the framings form an agreeably connected line; it being exactly on the same principle as the whisky, which was

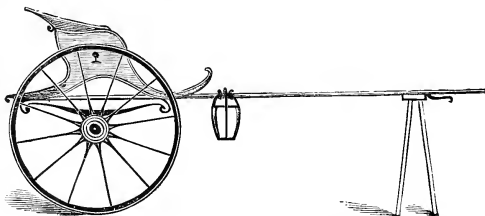

GRASSHOPPER-CHAISE WHISKY.

built from them, having the springs in the same way fixed to the axle-tree, and the body united with the carriage, but only different in its

shape; the framings of the body being much wider, shows more panel, which extends to the shafts at the corners, and is arched up in an agreeable form between the bearings. They have a more solid appearance than the whisky, and are on that account preferred by most persons, and in particular by those called 'Quakers,' and for that reason are by some called 'Quaker chaises,' and by others serpentine or sweeped-bottom chaises. As they are built on so near a principle with the last-described carriage (the half-panel whisky), there is nothing more to recommend them than the design and the superior strength on account of the panels filling most of the framings."

The body of the whisky curricule was after the same pattern as that shown in the gig curricule, and only differed in the carriage-part, as it was arranged for one or two horses, as might be required.

At the close of the eighteenth century, carriage-building had made great advancement in England, but it will be seen that during the early part of the present this advancement was still more strikingly manifest. The "straked-tire" (strips of iron fitted and nailed to the felloes in sections, the joints meeting in the center of the felloes), of primitive origin, was giving place to others of better form, so that in 1800 all wheels were either straked, hooped, or patent-rimmed. We are told that, in constant use, the first "wears out in twelve months, the hoop-rimmed wheel in fifteen months, the patent-rimmed wheel in eighteen months," provided they run "five miles per day in town and eight in the country, which is the shortest time they may be expected to last."

About this time a system of hiring carriages by the year appears to have sprung up. This at first was principally confined to coaches and chariots, built purposely for the occupier, and finished to suit his taste in the same manner as if they were to be purchased, and generally engaged for four years, the time they were expected to last. These were repaired (except in case of accident) and kept by the builder in wheels, who also supplied a suitable harness. Phaetons, curricles, or chaises, when built for hire, were, if only used six months in the summer, charged for as if for the entire year, as the carriage, being unsalable in winter, would be likely to lay idle the remaining half-year. In fixing the tariff of charges, the value of the vehicle let was taken into consideration, and to that added the probable subsequent expense in repairs during the period for which an engagement was made. To

get at the yearly value for the hire, the first costs of the carriage and its subsequent repairs being summed up, was to divide the amount by one more number than the years in use. One year's use was supposed to be the worth of the carriage to the builder when returned to him at the expiration of the engagement, and the others paid for the carriage while being used. To illustrate: when the carriage was used for four years, the costs were divided by five; if for three years, by four; and so on for a shorter or longer period. These contracts bound "the executors, administrators, or assignees" of the parties, except provision was made to the contrary by special contracts in writing, and in no case could the coach-maker demand the return of the carriage where an advanced tax had been paid, the law giving to the occupier a *provisionary* "fee simple" for the unexpired term. Carriages, whether with two or four wheels, were charged per day 4s. (84 cts.); if on Sundays, 5s.; or for a week, 24s. (about \$5). Where a carriage was let for a year or more, the occupier paid the crown duty, but in no other cases.¹

It seems likewise that early in the present century dealers in second-hand vehicles were regularly organized, whose "tricks in trade" would not disgrace some of our more modern horse-jockeys. Felton's forewarnings are so honestly and faithfully given that we must republish them. He says: "The great demand within the twenty years for second-hand carriages, for foreign and home use, has induced many unskillful persons to commence dealers, who call themselves *brokers*, and pretend to buy for the purpose of breaking up and disposing of the old materials, but who in general, instead of breaking up, 'vamp up' and resell such carriages at exorbitant prices, imposing thereby both on the public and the trade. The profit which those dealers realize on an old carriage of £50 or £60 price is commonly greater than the builder's originally was when new, and often exceeds the half of

¹ In later years this system of selling carriages has been somewhat changed to what is termed the "three-year system," under which the carriage was kept in repair for three years by the builder, to be returned to him at the end of the term, but the costs of hire were rather unsatisfactory to the customer, amounting to nearly as much as the purchase outright. To remedy this, Richard Andrews, of Southampton, let his carriages for the same number of years, with the stipulation that when these had expired the carriage became the property of the hirer, upon whom the costs of repairing fell. This mode of selling carriages still prevails in England to a large extent, but in no other country that we are aware of.

what it is sold for; yet many people imagine, if the price is about one half the original value, the purchase is reasonable, when in fact it is not worth one quarter or even an eighth.

"The means whereby these people are enabled to sell their carriages is by giving them a good appearance, and imitating as much as possible the fashion. This they do by ornamenting them, in particular with plated work, new painting, putting in a new lining with some showy lace, new wheels, or ringing [tiring] them with new iron to give them the appearance of new, adding new lamps, etc. All the materials used for this purpose are of the cheapest sort, manufactured on purpose, but which to a person unacquainted look for the moment as well as the best. The expense in fitting is chiefly bestowed in ornament, without in the least attending to the substance of the carriage, which is seldom worth one half for use of what is thus bestowed upon it in ornament.

"Brokers or dealers find a great convenience in *repositories*, now established in numbers, as they can there vend their carriages without being questioned as to their quality, which might otherwise detect the imposition; others who are of the trade sometimes make a convenience of a repository for the same reason as the brokers, as they may there vend what in their own shops they would be ashamed of. From the apparent advantages of purchasing from the repositories, people are induced to buy from them in preference to dealing with a private trader; but every person attending those places ought to act with double caution, as the principal stock belongs to the brokers, or dealers in second-hand carriages, who take care to furnish those places with a variety of all sorts. It is therefore the interest of the repository-keepers to recommend the carriages of brokers in preference to those belonging to strangers, which not only serves the brokers, but themselves; for from frequent selling, and being again immediately supplied by the same parties, nothing is lost by the rent for standing, and much gained by commission, while a stranger who has but one carriage to sell, the longer it remains unsold and at rent the better; when at last the proprietor, wearied with waiting, and having the expense increased, and the carriage prejudiced by long standing, is induced to accept the broker's price, who mostly becomes the purchaser.

"Another great disadvantage attending those places is, that as a

communication is seldom admitted between the buyer and the seller, they are both liable to be imposed upon, by exacting of the buyer more and paying to the seller less than the carriage was sold for; so that a considerably greater profit than that arising from the commission and standing storage may be derived by the repository-keeper, without adding anything to the value of the carriage thus sold.

"As there are such risks, it is to be recommended that no person will purchase from those places, but under the direction of some sufficient tradesman, who may be competent to judge of the real value of carriages in every state; for although a carriage may look fair by being disguised by paint and putty, which is artfully laid on, yet the carriage may be nearly rotten, and ought rather to be broken up than made use of."

To sell these "old traps" the ingenuity of the brokers was taxed to the utmost, and it was no unusual practice to pretend that it belonged to some nobleman who had parted with it because he had another more convenient, or that the owner had left for the Continent, or was dead. Another device was to put on some *fictional* arms, crests, or coronets, coupled with an old customer's name "of whom they had once bought a carriage," and perhaps the trick was repeated to sell a number of old carriages. It is true this trick could never take with Americans; but in England, where a lord is looked upon as "above the common herd," the case is different; and as the fashion did not change more than once in ten years or more, it was difficult to decide the age of a carriage, even by experts; the value could only be estimated by the wear thereof.

The duties imposed by the English government at the beginning of the present century were onerous, and inimical to coach-making in various ways. These were so laid that the more carriages a gentleman kept, the heavier in proportion he was taxed. On a four-wheeled vehicle the tax was £8 10s. (\$41) annually; and should the same owner have a second carriage, on that he was taxed £9 18s. (\$48); and if a third or more, on them he paid £12 (\$58.20) each. The duty on two-wheeled vehicles was uniformly £3 17s., or about \$18.44. The coach-builders were also made to pay 20s. for every four-wheeled carriage, and 10s. for every two-wheeled cart, those used for business excepted. So detrimental to the interests of trade did these taxes operate, it is said that more than half the members belonging to the

different branches felt a necessity for engaging in some other branch of business to get a livelihood. The reduction of these taxes twenty-five years afterwards saved the business from entire destruction, and gave a new impulse to coach-making, as will be seen in the coach

annexed, where the design is very much altered and improved, although still with some imperfections. Should the reader compare this with the one on page 336, he

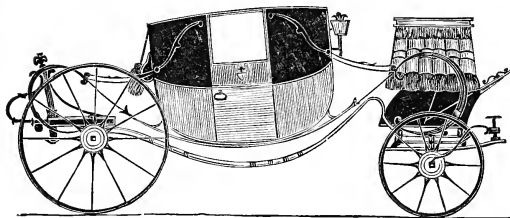

COACH, 1805.

will find that instead of being larger at the top, the bodies had run into the other extreme, and become wider in the center and narrower on the roof, with increased swell to the side panels. The C-spring had also been invented, and in many respects the coaches of 1805 were not inferior to those of the present day. If not quite as profusely ornamented, yet it was much more chaste and neat than its predecessor previously referred to. The price of this coach was £231, or about \$1,118.

The next most popular vehicle was the *post-chariot* for town and country, which cost £202, or about \$978. In this design the sweep of the crest panel is in bad taste, and the body on the whole not much

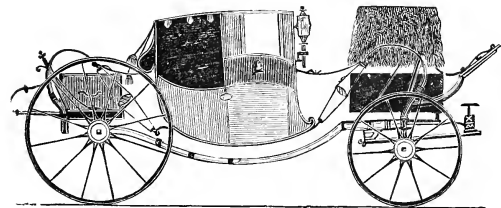

* POST-CHARIOT, 1805.

improved over the one on page 341. The springs are an accommodation of the old whip or S-spring to the form of the C-spring just then coming into fashion, and showing the progress of

art at the commencement of the nineteenth century. Here we find the bear-skin hammer-cloth for the first time, which in traveling was preferable to that of livery then in common use, and this was frequently

ornamented with metal claws at the corners. It was quite fashionable then in painting to finish the carriage with "oil varnish," whatever that may have been.

We have now reached a point in our history when phaetons, formerly so popular, had almost entirely gone out of fashion, and were superseded by the jaunting-car, and the German wagon or barouche, although the curriole and whisky still maintained their popularity. The improvement in the curriole in the course of twenty years may be seen by comparing the improved curriole with the one on page 345.

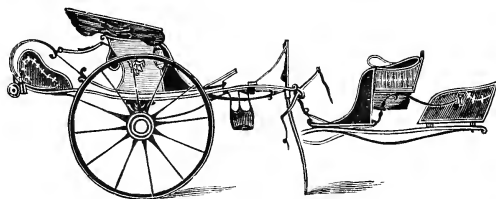

IMPROVED CURRIOLE.

The form of the body differs but very little, but the C-springs and compassed or bent shafts of ash are much more graceful. Here, too, first appears the toe-

spring (called in England the elbow) still retained in many of the gigs turned out from modern shops. The "rumbler" has been shaped to accommodate it to the C-spring, and the step, as a further improvement, is booted with leather, and has a metal cap put over the axles. The old sword-case of our boyhood "sticks out" in all its magnificence. The cost of a new curriole was £94, or about \$455.¹

A contemporary says of the *jaunting-car*, "This sort of carriage is quite novel in this country [England], but from its convenience is likely to become general. Its construction is light and roomy, with seats all round, and a seat in front for the driver, *which mostly is the proprietor of it*. It is capacious enough to hold from four to six persons besides the driver, and so light that one strong horse is sufficient for the draft, though another may be added, either abreast or as a leader, in the manner of a tandem, if required. It is a carriage

¹ "The most celebrated curriole of the last century was built of copper, in the shape of a sea-shell, and was driven by that caricature of dandies, Romeo Coates. The last curriole about town was Count d'Orsay's; and although the shape of the body of the carriage was inelegant, the effect of that kind of beplated luxury was very striking when the horses were perfect and the harness gorgeous and well varnished."—*All the Year Round*.

well adapted for a party on pleasure, or as a family airing-carriage in parks, etc., and supersedes the sociable." It may have a head if required, but everything that gives weight should be avoided. This car is mounted upon "long double-elbow springs, extending from the fore to the hind bar, but the body must be framed on the carriage [shafts], and have only grass-hopper springs under the shafts, which will be

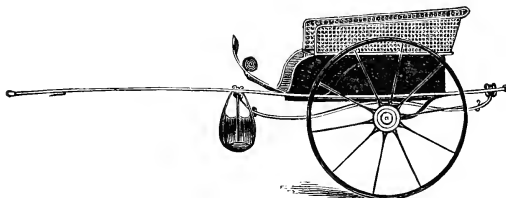

JAUNTING-CAR, 1805.

both lighter and cheaper, but not so elegant or easy. There is in general no lining or stuffing inside, only cushions for the seats, the bodies being generally caned, but are sometimes railed or paneled." The cost of the best in Felton's time was about \$235. In our times jaunting-cars to an Irishman have special charms, and when driven by a good-natured "Paddy" are not without some interest to a stranger. We have one in New York of Irish manufacture, but the sea-voyage to which it was necessarily subjected appears to have taken the *romance* out of it entirely. Very few Americans care to ride in it. Besides this, for an Irishman it requires the surroundings he finds on "the old sod" to make its use pleasant and interesting.

Cars in Ireland are of three descriptions, — the covered car, and the inside and outside jaunting-cars. Covered cars are of comparatively recent introduction, being in fact the hackney-cabs of the larger towns, their sole recommendation being that they are water-proof; for they effectually prevent any view of the country, except through two small windows in front, or by tying back the oil-skin curtain in the rear. The inside jaunting-car differs from the outside jaunting-car in being rather more closed at the sides, both being open vehicles, or, as the Americans say, without tops.

The outside jaunting-cars, which are in European eyes lightly constructed, are the cars *par excellence* of Ireland. They invariably are drawn by a single horse, the driver occupying a small seat in front. A recent traveler, looking at these cars from an inimical standpoint, tells us that "the floor is composed of a few boards, the box having

two sides, which are raised up and down on hinges, raised for no other use, that I can see, except it be to grease the wheels. The sides are of canvas, stitched on wooden frames, which drop from the edge of a seat, and have a foot-board at the bottom of the frame. The backs of the two seats form a narrow *well*, as it is termed, for the storage of luggage in the center, a name by no means inappropriate, as it is generally full of water when it rains. . . . If the car has its full fare of four persons, and the Hibernian Jehu must in that case keep to his stool, it may happen that, twitching the mouth of his jaded beast by way of coaxing him into a trot, he pokes his elbow into his neighbor's face, with which it is just on a level. With this number, in going *up* hill, the whole weight of the front passenger falls upon him in the rear, which is by no means agreeable, particularly if he should chance to be a heavy one; and the same thing must happen to the front passenger in going *down* hill." If there be but *one* in the car, the driver inquires, "An which side of the country would your honor like to see?" Then quitting his seat in front, he perches himself, very much at ease, cross-legged on the opposite side as ballast. This, however, does not prevent his customer's shifting to the front end of his seat in going down hill, nor his involuntary thrust to the other extremity in going up. To *encourage* the passenger, he is told, "Och, your honor will aisily fall into the way of that."

One Bianconi, recently deceased, has become famous in connection with his car system, established in Ireland in 1815. This gentleman built his own cars at his factory at Clonmell. His charges at first varied from one penny to twopence-halfpenny per mile, according to the quantity of business on the road and the speed of the car, which at the slowest was six miles an hour, and at the quickest nine. He took much pains to have his vehicles furnished with comfortable horse-hair cushions, in wet weather changing them every two stages.

In their work on Ireland, Mr. and Mrs. S. C. Hall thus refer to the incalculable benefits Mr. Bianconi has conferred on the citizens by his system: "In the interior of the country, from which the farmers come to the little villages, they have only a few places for obtaining their commodities, and at an enormous rate; but since the introduction of these cars, people in business, who hitherto were obliged to go to market at a very heavy expense, which prevented their doing so frequently, now find their way to the larger towns, and have been enabled

to secure supplies at once from the first-cost market; and from the cheapness of bringing the articles home, they were enabled to reduce their prices considerably, and in those districts the consumption has in consequence wonderfully augmented, and shops or fresh sources of competition continually increase, thereby enabling parties to use articles hitherto inaccessible to them. A great saving of time is also effected; for example, it took a man a whole day to walk from Thurles to Clonmell, the second day to transact his business, and the third to walk back; now, for seven shillings, he purchases two clear days, saves himself the trouble of walking sixty English miles, and has four or five hours to transact his business."

On page 329 we have illustrated the earlier English barouche. In the next engraving we give an improved design, constructed much lighter. This became very popular with the "sporting bloods" of the period in visiting the race-courses, when the proprietor generally acted as driver, having in all such cases a shifting dickey-seat provided for that purpose,

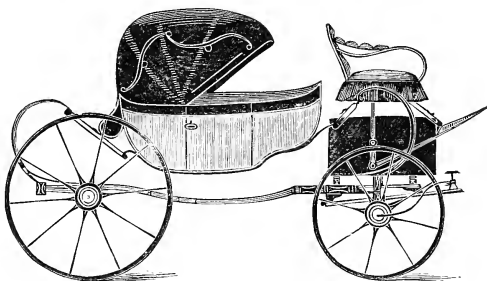

BAROUCHE, 1805.

as seen in the picture. One striking peculiarity in this vehicle is, the hanging-off loops are continued the entire length of the body on the lower edge of the bottom side. This gave strength and solidity to the whole, which was highly gratifying to the public at a time when the people were less regardless of danger than in modern times. The price of this barouche was £200, or about \$968.

The *telegraph* was a singular vehicle, sometimes used as a dog-cart. These carriages were made after different patterns, with large bottoms for the stowage of dogs used in hunting. Some of these bodies were full paneled and fancifully molded off, and nearly all built upon the shafts, in the manner of the jaunting-cars previously noticed. We have illustrated the most fashionable style of the telegraph, the lower part of the body of which is made after the prevailing design for a

Salisbury boot to coaches, and is furnished with what was known as the barouche seat. Our example is hung on four long steel springs, two attached to the carriage-part, parallel with the hind and fore bars, uniting

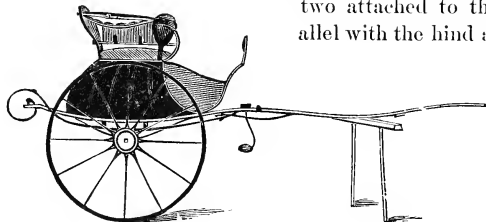

TELEGRAPH, 1805.

at the extremities by cross-shackles. Some others were hung upon long bottom springs connecting with the carriage-part by short scroll-springs,

having long braces from the jacks behind to the loops forward. The price for a telegraph was £64, or about \$310.

A score of years had now passed since Felton's exposition of some of the "tricks of trade" had been given, but instead of improvement we still see rascality flourishing in a new phase. We now find that "the encouragement given by the public to repositories has induced many persons no way connected with the trade to speculate in supplying them with articles of the most abominable kind, and which may properly be termed gingerbread carriages; and now that a change has taken place in the fashions, a fresh opportunity presents itself for vending their gay painted trash; and though many have bought experience from those places, yet a caution is necessary to prevent those who have not yet been taken in by them.

"Those places are principally supplied by persons working in garrets or kitchens, who vamp anything up for sale that can safely go in and out of the repository without failure; and many old carriages which ought to be broken up are dressed up in a fashionable style and frequently sold there for as much as would have purchased a new one from a coach-maker. The facility with which gentlemen are supplied induces them to attend those places; but as caution is necessary, none should purchase from them except on the recommendation of a respectable tradesman, in particular those new-fashioned fitted-up carriages. Gentlemen, likewise, who are unacquainted with the fraudulent practices of those places, are induced to send their old carriages there for sale; but unless a price is put on them as the repository-keeper thinks will put an extraordinary profit in his pocket, it may stand till the

expense thereof amounts to its value, when it comes into his hands without his advancing a shilling; as their own stock, or that of their regular customers, is always certain of having the best recommendation, although not half the value of the others. It may appear incredible, but can be affirmed on oath if desired, that carriages to a superficial observer shall appear alike in every respect, and one shall cost nearly double the sum which the other did. Hence arises the opinion that the repositories are cheaper than the manufacturers; but the one, having credit to preserve, builds of good materials; the other deals for ready money only, *and mostly sells his goods and customers at one time.*"

A coach-maker of London, one Obadiah Elliott, in 1805 obtained a patent for "certain improvements in the construction of coaches, chariots, barouches, landaus, and various other four-wheel carriages, without a perch"; and in the drawings illustrating his specifications, we for the first time find something that looks like the elliptic spring applied to a vehicle. It is true that we have an inkling of the future mechanical perfection in the front part of the sociable on page 344, and as the result of our researches give it as our opinion that this *ne plus ultra* of inventions is the growth of several years.

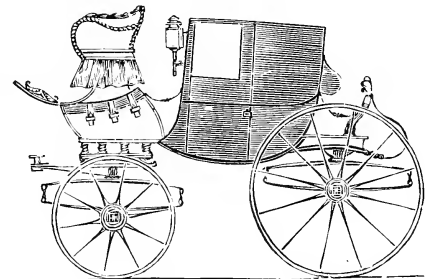

O. ELLIOTT'S CHARIOT, 1805.

About the time of Elliott's invention, a gentleman in England secured a patent "whereby persons riding in carriages may on occasions, and in circumstances of imminent danger, liberate themselves and escape impending danger by freeing the horse or horses instantly from the carriage; and in case of two-wheeled carriages, causing them to stand in the same horizontal position as they were before the horse or horses were freed from them, by the carriage stopping in the space of a few yards, without any violent concussion or danger of overturning the person in the carriage, who may sit the whole time with perfect ease and safety." We give a condensed description of it:—

When applied to a curriole, which we have lately seen was quite popular in England, the splinter-bar was made of the best seasoned ash, with a recess formed in the back of it to receive an iron shaft or spindle, half an inch in diameter, of two lengths, to which were fixed four iron hooks, one at the end of each shaft, moving in a circular position; also an iron lever, with two flanges, one of which was fixed to each shaft by nuts and screws. That part of the apparatus which fell to the ground to assist in stopping the carriage was called the "anchor." This was made of wood and iron, or iron alone, fixed to the axle-tree by two couplings on each side, nine inches from the center, with small holes in them, sufficient to admit an iron pin, which passing through the two iron flanges attached to the anchor as well as through the couplings; the anchor by that means moved from the center of the small iron pin at the axle-tree, the lever resting on the anchor, as it might either be enclosed in a groove made to receive it on the upper side of said anchor, or the lever might be so constructed as to lay on each side of the anchor supported by bolts or rollers. By this means, when the apparatus was raised as high as the carriage would admit of, it was secured in position by a spring bolt, to which was attached a strap leading into the carriage, which in supposed danger was pulled, freeing the anchor and lever, thereby stopping and supporting the carriage. For carriages with four wheels the apparatus was the same, except the fixing of the anchor, which to be effective was to be placed upon the hind axle-tree or the perch, and which, the moment it fell to the ground, steadied the carriage and prevented its swerving from the road. By means of two iron flukes attached to the anchor, the carriage was stopped within twelve yards!

The *Stanhope* came into use somewhere about 1815, and received its name from the inventor, Hon. Fitzroy Stanhope, a brother of the Earl of Harrington. It was popular in England for a short period, and not long after adopted in America, but has since been laid aside. The body rests on two cross springs, the ends of which are suspended from the two side ones. This arrangement gives an easy motion to the rider, but is very hard on the horse's back, on account of the concussion of the wheels on rough roads.

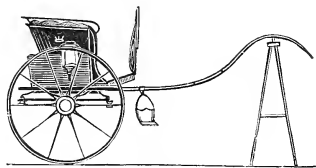

STANHOPE GIG.

"The connection between the side and cross springs," Adams says, "was formerly merely links, as in ordinary stage-coaches; . . . but the jingling noise soon caused noiseless shackles to be continued, working on smooth centers." Leather braces have since been substituted as being still less noisy. Our engraving gives the general features of a Stanhope, from which there has been but little change since.¹

The next engraving represents a *Tilbury*, invented by a carriage-builder of that name, which, being much lighter than the Stanhope, was very popular at one period, although, like it, very hard on the horse. Originally these are said to have been made without springs and hung on thorough-braces, like the gig, of which these two-wheeled vehicles are but modifications. The cross-spring of the Stanhope in this instance is fixed on the top of an iron frame, secured to the back ends of the long shafts, its peculiar arrangement making it liable to twist by the uneven movements of the vehicle.

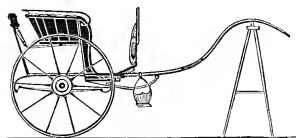

TILBURY.

Although this carriage looks lighter, it is said to weigh more than the Stanhope, by reason of the great weight of iron required in the construction, having altogether seven springs and other

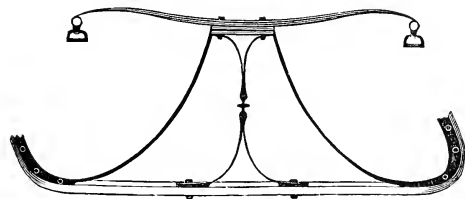

TILBURY SPRING.—REAR VIEW.

weighty fixtures about it. Messrs. Hooper & Co., of London, inform us that this vehicle dates from about 1828.

The engraving on next page represents an English *curricule phaeton* of about the year 1815. We suppose it receives the name "curricule" from the shape of the body, and "phaeton" because it is set on four wheels, the combination making a very useful carriage for the times in which it originated. The manner in which the lamp is secured to

¹ This and the next design were furnished by Messrs. Hooper & Co., of London. Charles, Earl Stanhope, was the inventor of numerous useful articles, among which is the printing-press, which bears his name. Born 1790; died 1807.

the front-pillar is worthy of notice, as being placed in the most favorable position for effective illumination, and out of the way of the passenger on entering the phaeton, — a matter often overlooked by coach-builders.

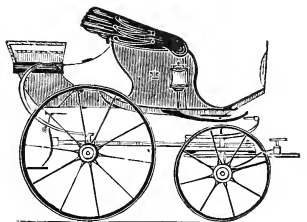

CURRICULE PHAETON.

sably necessary to four-wheeled carriages of every kind," because it could be turned in a very limited space, and besides allowed a shorter coupling of fourteen or fifteen inches, *thereby diminishing the draft*, giving it security; allowing of higher front wheels and hanging the body lower; it was not so easily broken as the *stiff* axle, required only six pieces, including the pole, whereas on the old plan twenty were used. To crown all, the inventor says, "The light and airy appearance, the beauty of good lines, combined with solidity, have always been with gentlemen of taste and the coach-maker of ingenuity the principal object in the building of carriages. All these qualities are here combined in one simple but most valuable invention, producing at once safety, ease, and elegance."

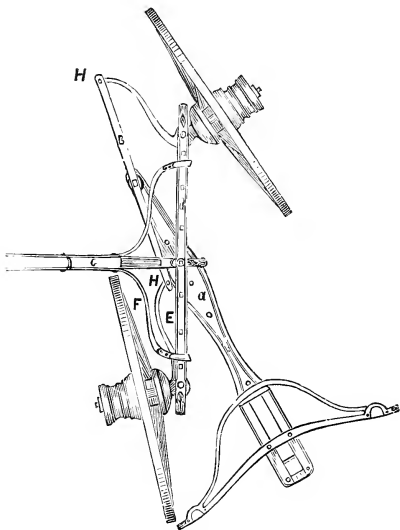

ACKERMAN'S MOVABLE AXLE.

This was indorsed by George Lankensperger, of Munich, coach-maker to his Majesty the King of Bavaria, who had "experimented"

with it on numerous customers of his among the aristocracy of that kingdom.

The next engraving represents a *chaise-de-poste*, or post-chaise, built by Adams & Hooper, of London, about 1825. This, for a short journey into the country previous to the institution of railways, was a very convenient carriage for a small party, as well as easy riding, it being suspended upon C-springs. In this instance three lamps are employed, sufficiently indicative of bad roads.

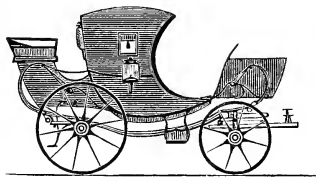

POST-CHAISE, 1825.

At the hind end is fixed a seat for two servants, and in front a box, answering at the same time the purposes of a driver's seat and trunk for baggage.

Another carriage for Continental travel is seen in the next illustration. In Europe it is called an *eilwagen*, or *britzscha chariot*, which

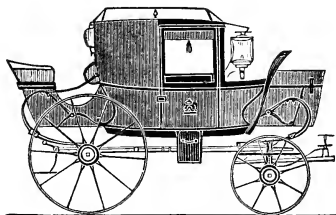

BRITZSCHA CHARIOT.

Adams tells us "is distinguished from the ordinary posting chariot by the form of the body, the lower part of which is shaped something like a *britzscha*." This drawing represents the chariot built by Messrs. Adams & Hooper, of London, for the Earl of Winchelsea, in 1825. The box under the seat extends the body so that there is

ample room to lie at full length while traveling, the folding steps being placed outside and out of the way of the sleeper. This and the previous carriage have lamps placed behind for the convenience of readers at night. An imperial is fixed on the roof for carrying baggage, in addition to other conveniences found in the post-chaise.

The first railway coach in England, built after a design by George Stephenson, was started as a passenger coach on the Stockton and Darlington Railway, Oct. 10, 1825. It was drawn by a single horse twelve miles in two hours, fare one shilling, and called the "Experiment," which proved so successful that old stage bodies, mounted on under frames, with flange wheels, were improvised to accommodate the public. This, as we shall see in the end, proved the death of

post-coaches used by Continental travelers. In Smiles's "Life of George Stephenson" occurs the following passage:—

"There were two separate coach companies in Stockton, and amusing collisions sometimes occurred between the drivers, who found on the rail a novel element of contention. They could not pass each other as on the road, and as the line was single, with four sidings in the mile, when two coaches met, or two trains, the question arose which of the drivers should go back. This was not always settled in silence. As to trains, it came to be a sort of understanding that empty should give way to loaded wagons; and as to trains and coaches, that passengers should have preference over coals; while coaches, when they met, must quarrel it out." At length, midway

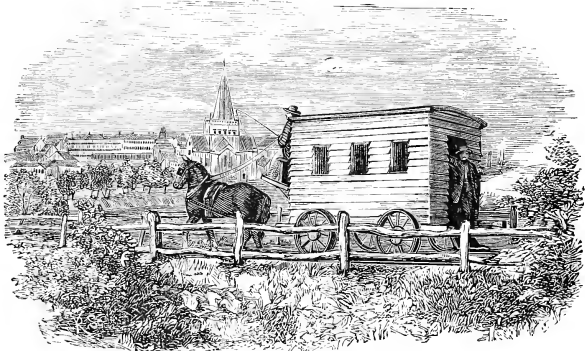

FIRST ENGLISH RAILWAY COACH.

between sidings a post was erected, and the rule was laid down that he who had passed the pillar must go on, and the "coming man" go back. At the Goose Pool and Early Nook it was common for the coaches to stop, and there, as Jonathan would say, passengers and coachmen "liqoured." One coach, introduced by an innkeeper, was a compound of two mourning-coaches,—an approximation to the real railway coach which still adheres, with multiplying exceptions, to the stage-coach type. One Dixon, who drove the "Experiment" between Darlington and Shildon, is the inventor of carriage lighting on the rail. On a dark winter night, having compassion on his passengers, he would buy a candle, and place it, lighted, among them on the table of

the "Experiment," the first coach that indulged its customers with light at night. And this idea probably was suggested by the practice of hanging a lamp at the rear window of a post-chaise or chariot in traveling.

In 1826 Col. Viney and G. Pocock patented a carriage, to be moved along by the mere force of the wind acting upon one or more kites attached to the carriage, which they called a *charvolant*, a picture of which is here given. The kite, *a*, is jointed in the middle so that

it may be folded up and put away when not in use. The cords, *b, b*, regulate the position of the kite and assist the steering, for which purpose the ends of the cords pass through the dead-eye, *c*, to the hands of the passenger,

who shortens or lengthens them at will, so as to turn the car

either to the right or left. By the cross

handle, *e*, and the stem, *e, f*,

which acts on the axis of the fore wheels by means of an endless

band or cord passing about a pulley, *f*, and fixed on the lower end of the stem, *e, f*,

and the pulley, *g*, fixed on to the bed of the axle-tree of the fore wheels, the machine is stopped or its motion retarded by the drag, *k*, which is attached to the perch by a spring to keep it off the ground until needed, when the fluke end is pressed into the earth by the lever, *h*, acting on the connecting piece, *i*. This machine, like a great many others invented by "outsiders," is of little service in practical use.

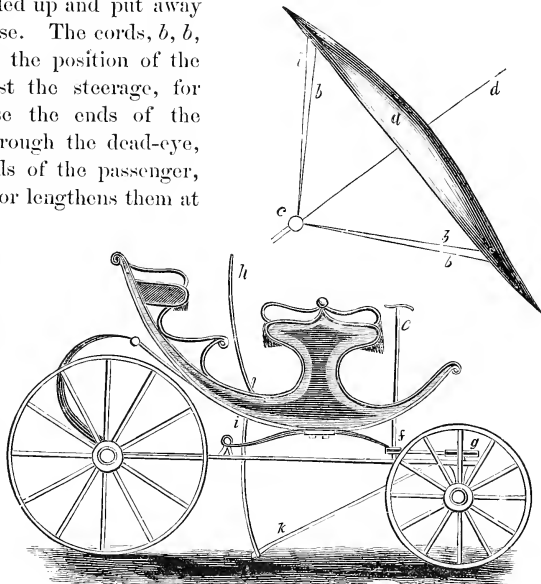

VINEY AND POCOCK'S CHARVOLANT.

A late writer tells us that English carriage constructors, as a class, are not an inventive race, they having only given names to the whisky, gig, Stanhope, Tilbury, Dennet, buggy, and jaunting-car, all other varieties having a foreign origin, six of those named being only variations of the same thing. This, however, is no proof that they are lacking in inventive talent.¹

We have now reached a point in our history where Continental traveling was at its height by the nobility of England. The next four illustrations will show with how much success the British coach-builders were supplying the needed requirements of their customers when the construction of railways abroad changed the entire order of things,

and put an end to a very profitable trade, as previously hinted.

The first design represents a chariot of singular construction, which when in use served the purposes of a lodging-house at night as well as a traveling carriage, the extension beneath the

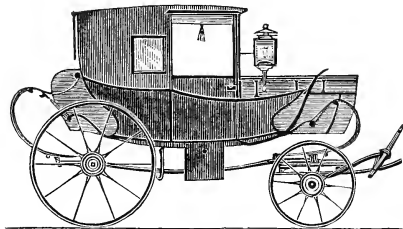

TRAVELING CHARIOT.

driver's seat supplying the additional space required for the sleeper's feet. The accommodations in this vehicle were extremely limited, the requisite boxes and "other fixings" for transporting luxuries in long journeys being conspicuous by their absence.

The second design represents a traveling coach of more showy pretensions, having, in addition to the sleeping arrangements of

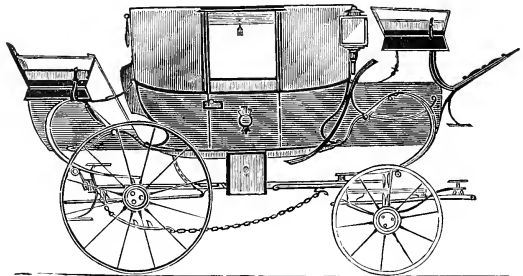

CONTINENTAL TRAVELING COACH.

¹ See William B. Adams's *English Pleasure-carriages*, p. 156.

the foregoing, a rumble added for the accommodation of the servants attendant upon "his honor" when abroad. The drag-chain secured to the reach is indicative of uneven roads, in lands where age might have served to have leveled them. Adams, in referring to these posting vehicles, informs us that "the lumps are black, and made to shift and hide the glass in the daytime. For town use, the traveling furniture can be shifted, and a hammer-cloth seat and standard substituted. For persons who wish to lie at full length, the front panel can be taken away, and the fore end lengthened into a boot called a 'dormeuse.'" ¹

The third design represents a *composite chariot*, — chariot and gig in combination, — likewise accommodated to travel on the Continent. Although an inelegant and clumsily constructed machine, it appears to have had many conveniences not found in the more simple post-chariot of former days.

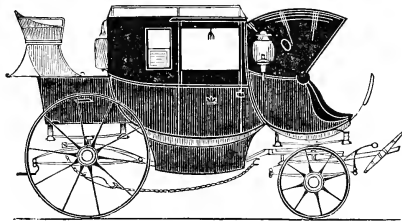

COMPOSITE CHARIOT.

The next illustration represents a four-horse *post-chariot*, built by Messrs. Adams and Hooper, of London, for H. B. Hoghton, Esq., in 1829, and is about the last constructed for traveling in Europe, a general

introduction of railway locomotives having entirely superseded the slower mode of journeying by horse power. The body of this chariot being hung off upon elliptical and C-springs in combination, renders it easy

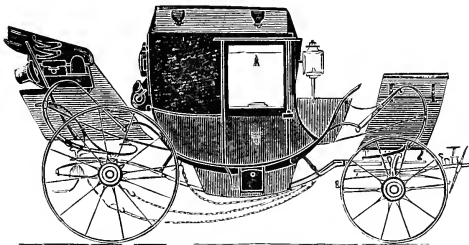

POST-CHARIOT, 1829.

riding. On the roof is an "imperial," and between the front-pillar and dash-board a "cap-case." Beneath the driver's seat is found a

¹ *English Pleasure-carriages*, p. 225.

leather trunk, and beneath the servant's seat at the rear is another, to the sides of which are hung a small valise and hat-case, sufficient, one would think, for the storage of all the luggage a lord would deem it prudent to carry behind six horses.

The reader must have noticed that these traveling machines were uncouth, constructed with very slight regard to the laws of taste, comfort rather than elegance in form being the first consideration with travelers. It required at least six horses to move these unwieldy machines over the mountainous regions, which if left with the traveler would saddle him with heavy charges for horse-feed, etc. Foreseeing this, in many countries the government used to provide extra horses at fixed rates, which being hitched in front, assisted in drawing a vehicle to the summit of a hill, where the animals were dismissed and led back to the starting-place for a new-comer, this process being repeated whenever necessity or the laws required. Sometimes oxen were substituted for horses, and in some cases, under the impression that bovines would draw a load the more easily, a man sat on the end of the pole between the animals, or else an extra weight was attached underneath — sometimes stone in a basket — for the purpose of producing like results.

Many amusing specimens of literary composition have already been given in this volume, but nowhere have we found a more curious example of the alliterative than what follows. It originated between two rival coach proprietors, who were each about to start separate lines from Paddington, London, in 1829. It reaching the ears of one that his opponent had given directions to have emblazoned on his vehicle, "The Agreeable Alliance, An Actual Accommodation, Affording an Assylum against Abuse," the other immediately ordered his coach adorned with the following counter-effusion: "The Competent Competitor, a Complete, Comfortable, Capital, Conscientious Conveyance, Certainly Countenanced by Counts and Countesses, Country-folks, Country Cousins, Commercial Coves and Considerable Citizens, Combining Common Charges with constant Care and constant Civility." How the rivalry terminated we are unadvised, but since knowledge is said to be wealth, the C's must have carried the — passengers. This, however, is digressive.

Over seventy years ago — in 1805 — Messrs. Bradshaw and Rotch, the latter a member of Parliament, a barrister, and likewise a chairman

of the Quarter Sessions, obtained a license for eight cabriolets, which were started in London at fares one third lower than was charged for the old hackney-coaches. In 1832 these numbered sixty-five, when all restrictions as to the number were removed. Of Continental origin, under different forms, one of which is given below, and with many improvements which will be noticed as we proceed, it has for many years, as a cheap mode of conveyance, been popular in the larger cities. All these two-wheeled vehicles are intended for two passengers only, some with stationary, others with falling heads, that can be either opened or closed according to the will of the occupant or the state of the weather. With an apron drawn in front, the riders are almost entirely sheltered from the storm.

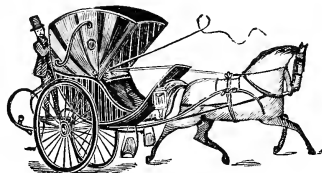

PRIVATE CABRIOLET.

When used as a private carriage, as in our illustration, a boy is mounted behind, whose office is to dismount when the owner alights, and take charge of the vehicle in his absence. An English author says, "It is a very convenient vehicle for unmarried men to go out in at night and return either from a dinner or from the theater or opera or houses of Parliament: it saves the inconvenience of a close carriage, two horses, a coachman and a footman, which when out late at night involve a large amount of trouble and expense."¹

Of this class of vehicles are the hackney-cab and hansom, both requiring large and powerful horses to move them. When first introduced, the driver sat on the same seat with his fare; afterwards a little dickey-seat was arranged on the left side for his accommodation. This proving unsafe, other contrivances were resorted to: one placed the driver immediately over the fare, in another case behind. Then came the plan of making them close vehicles, some with two wheels, others with four.

Many bitter things were uttered against stage-coaches on their first introduction, as has already been recorded in these pages; but an interested advocate for steamboats in 1827 goes ahead of them all in the condemnation of stage travel. He says, "If the number of per-

¹ *English Pleasure-carriages*, p. 240.

sons who have been killed, maimed, and disfigured for life in consequence of stage-coach *mishaps* could be ascertained since the establishment of steam-packets in this country, and, on the other hand, the number who have been similarly unfortunate by steam-boilers bursting, we should find that the stage-coach proportion would be in the ratio of ten to one."¹

But a revolution in city travel is now about commencing, for "in July, 1829, amid the jeers and howls of the London hackney-coachmen," the first *omnibus* — afterwards increased to twelve — was started by one Shillibeer, who had lived some time in Paris as a coach-builder,

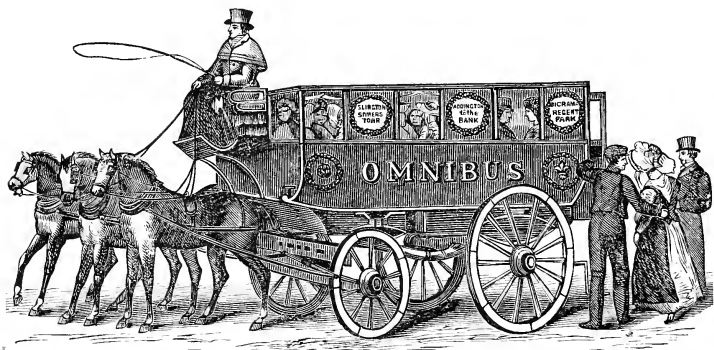

FIRST ENGLISH OMNIBUS, 1829.

and had noticed the success of this system of conveyance, inaugurated by M. Lafitte ten years before. An illustration of Shillibeer's omnibus is given above. It was drawn by three horses abreast, and must have been a very clumsily made vehicle. The route taken was "from the Yorkshire Stingo to the bank, the charge being one shilling the whole way, with a half-fare from or to King's Cross."²

The success of this enterprise was at once apparent, the profits being £100 a week at first. The stage-coachmen strenuously opposed their running under terms of an Act of Parliament, and the hackney-coachmen, feeling a reforming wind beginning to blow against them, threw

¹ See Hone's *Table Book*, London, 1827.

² *Once a Week*, 1864. The article complete was reprinted in the *New York Coach-maker's Magazine*, Vol. VI, pp. 20-35.

every difficulty possible in their way. The cheapness and convenience of this mode of transportation found favor with the public from the first, and consequently the selfish enmity from interested liverymen was of no avail. Individual enterprise kept omnibuses running in London down to 1857, when they principally were bought up and run by the London General Omnibus Company, a joint-stock concern, at a cost of £2,000,000.

The next engraving represents an English *gig*, fashionable in 1830. Adams tells us, "The vehicle formerly known as a gig was the lightest one-horse vehicle used in England.

It is simply an open-railed chair fixed on the shafts and supported on two side-springs, the hinder ends of which were connected to loop-irons by leathern braces to give greater freedom of motion. The wheel was larger and the body kept higher than the Stanhope, for which reason the shaft required less curva-

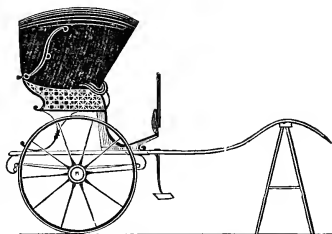

ENGLISH GIG, 1830.

ture. This vehicle ran exceedingly light after the horse, and the shafts were usually of lancewood, to give sufficient play. The side-springs were long and easy, and the whole vehicle was well adapted for traveling purposes. . . . Occasionally they were used for sporting, when the locker was made with Venetian blinds to carry the dogs, and then it became a dog-cart." ¹

An English coach-builder who furnishes the next design calls it a *cab dennet*, after a builder of that name, the body of which is an improve-

ment upon the pony-phæton previously given. Adams, in "English Pleasure-carriages," after mentioning that the dennet has three springs, tells us that he has heard that it "was named after the three Miss Dennets, whose elegant stage-dancing was so much in vogue

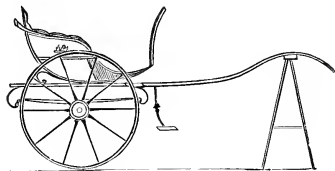

CAB DENNET.

about the time the vehicle was first used."

¹ *English Pleasure-carriages*, p. 245.

We have previously shown a *cabriolet*, copied from the "Saturday Magazine." We now give an illustration furnished us by a London coach-maker, which gives the reader a much better design than the former, this being drawn from a vehicle built by Messrs. Adams & Hooper, of the city before mentioned. One peculiar feature in the

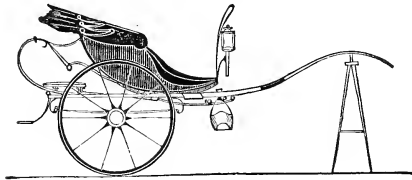

CABRIOLET.

design is the graceful sweep of the outlines to the body. The shaded portion in front is called the knee-flap, serving as an effectual protection to the lower limbs of the passenger in stormy weather, and is quite an improvement upon the chaise, of which it is a modification. We have said that the cabriolet has for a long time been popular in England. An English author says, "The principal reason why this carriage is so much liked, is its great convenience. It carries two persons, comfortably seated, sheltered from the sun and rain, yet with abundant fresh air, and with nearly as much privacy as a close carriage, if the curtains be drawn in front. It can go in and out of places where a two-horse carriage with four wheels cannot turn."¹

The next engraving represents an English *mail-phaeton* of the year 1830, with the seats contrived to shift, the front one back, or the back one in front, as occasion requires. After much research, we have not been able to learn why this is called a "mail-phacton," although probably because at some period a similar one has been employed in carrying "the royal mail." It is evidently a great favorite with the English, being convenient for either town or country, and considered by them a very light four-wheeled carriage.

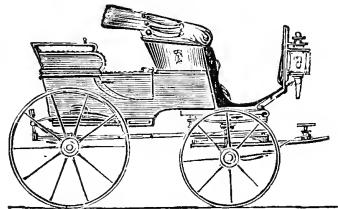

MAIL-PHAETON, 1830.

These phaetons in town are generally driven by the owner, for which purpose, as in our design, the best seat is placed in front. In wet-weather traveling, the servant

¹ *English Pleasure-carriages*, p. 240.

drives, when the seats are made, with the occupants, to change places.

In England, it is not an unusual thing to see a liveried attendant sitting bolt upright in the hind seat, with arms folded, bearing in his countenance a serious look, that would more befittingly become a funeral than the character he is supposed to act while occupying the best seat in the phaeton. While the "servant" is thus enjoying himself, the "master" handles the ribbons, in conformity with the strict rules of fashion and lordly taste. Occasionally "a stranger" is seen in America indulging in his old-country fancies, at which time he is "the observed of all observers," and the laughing-stock of republican plebeians. Such is taste!

Some time in 1834, Joseph Hanson, of Hinckley, in the town of Leicester, architect, applied for a patent, the nature of which consists in the construction of vehicles or carriages for passengers, goods, etc.,

which has since, under modified forms, become very popular in England as a street cabriolet.

In the claim dated June 23, 1835, the inventor gives us several points explanatory of his patent: "*Firstly*, the centers of the wheels, or other equivalent rotating agent, may correspond to any degree that may be fitting or expedient with the line of traction or propulsion, and at the same time the

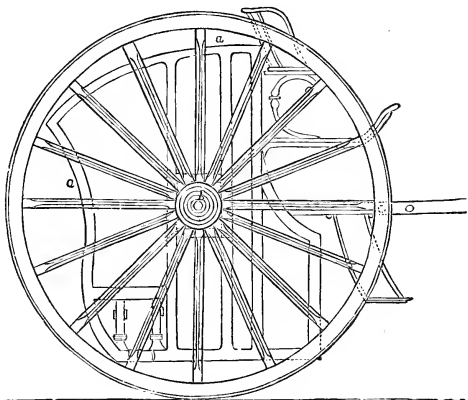

HANSOM'S CAB. 1

wheels be of much larger dimensions, and the body part of the carriage, which reaches much nearer the ground than has been hitherto conveniently practicable: *secondly*, that the wheels and shafts may

¹ This drawing is a reduced copy of the original in the British Patent Reports of 1835. Although the principle is still maintained, it bears but faint resemblance to Hanson's design in our time.

in all cases be of the dimensions best adapted to facility of draft, and in certain cases the wheels to be dispensed with altogether (that is to say, understanding by the term 'wheels' what are usually so called, being felloes, naves, and spokes); and *thirdly*, that the part appropriated to the load or body part shall in the case of passenger carriages be more easy of entrance and exit than the body parts of such carriages now usually are, and in the case of carriages for the conveyance of goods and other articles of dead weight, that the said body part may be conveniently detached or reattached upon loading or unloading." The inventor still further says, the "traction and propulsion, the wear and tear, and the risks of accidents, will each and all be greatly lessened."

This vehicle, so very popular in England as a hackney-cab, has since on two occasions been placed in the streets of New York for public conveyance, but in every instance only to be treated with neglect. American taste appears to run in another channel. Although not a very easy running carriage on paved streets, — what two-wheeled vehicle is? — still something of the kind is needed to cheapen the fares which at present prevail among us.

According to the "Penny Magazine," in 1834 there were, in London alone, two hundred and sixty-four coach-makers, and one hundred and eight manufacturers of parts of coaches, the same authority assuring us that "England was then better provided with carriages than any other country." But soon after this there arose a would-be reformer, in the person of William B. Adams, who, after admitting that "English pleasure carriages, take them altogether, are the most perfect carriages constructed in any part of the world," tells us that "the mistake has been in confounding high superiority in existing art with absolute perfection." To show that English carriages are still far short of perfection will be no very difficult task. "A large wheel following a smaller one, without being able to overtake it, is the description applied by some quaint author to a carriage. Herein consists the source of the principal part of the defects of carriages."¹ This *defect*, originally devised to allow of short turning in four-wheeled carriages, Mr. Adams proposes to remedy with equirotal (equal-sized) wheels, a pivot in the center of the body — which is constructed in halves — affording facilities for "cramping."

¹ *English Pleasure-carriages*, London, 1837, p. 256.

The first equirotal carriage thus made was a phaeton, which, according to Mr. Adams's account, was drawn with much greater ease to the horse than an ordinary phaeton of similar form and weight, and produced none of the unpleasant rumbling noise common to ordinary carriages. Other advantages besides those mentioned are claimed for this invention, such as allowing the driver to sit square behind the horse in locking, the springs being all on one horizontal level, all play alike, and in turning, the vehicle is free from the tremulous motion experienced in other carriages.

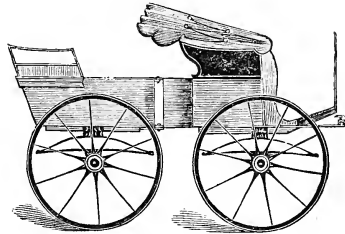

ADAMS'S EQUIROTAL PHAETON.

This mode of construction was likewise applied to cab-phaetons, droitzschkas, chariots, mail-coaches, and omnibuses, of which two last we give illustrations, and, as the whole vehicle is closed in, the separation into two parts, one connected with each pair of wheels, would not be advantageous. The inventor therefore proposed that his omnibuses should be jointed in the middle, the opening being supplied with flexible sides of leather. Mr. Adams claims for his "bantling" the following advantages: "It will turn with facility in the narrowest streets without impeding the passageway along the interior, as the flexible sides move in a circle. With this omnibus two horses would do the work of three;

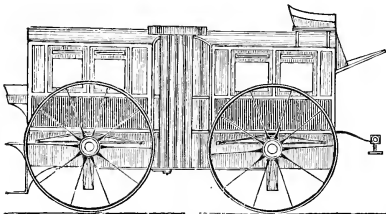

ADAMS'S EQUIROTAL OMNIBUS.

there would be great facility of access and egress; perfect command over the horses; increased ease to the passengers; greater head-room and more perfect ventilation; greater general durability, and absence of the usual rattling noise, accompanied by entire safety against overturning."

Although, at the time, Mr. Adams's novelties attracted much attention, yet we are not aware that his dreams have been realized by the general adoption of his invention in England; and we suspect that it will be a long while before the public is brought to coincide with his

opinion, or favor his scheme. One objection to his novelties is that they make a clumsy-looking carriage; another, a new kind of spring had to be applied in some vehicles, and these, although introduced with all the enthusiasm of a speculator, have not answered their purpose as well as the older inventions. On introducing his "regulating bow-spring," Mr. Adams singularly says, "If it be desirable to convert swords into ploughshares and pruning-hooks, it must be equally desirable to convert our bows into carriage-springs," — an argument in this instance of not much force.

The improvements of Mr. Adams did not stop the progress of art nor prevent the construction of carriages with "large wheels following

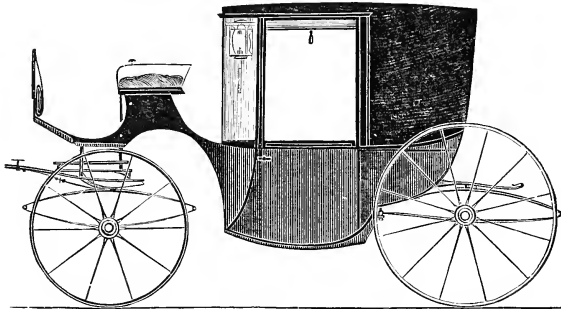

ENGLISH BROUGHAM.

a smaller one," for in a few years (1839) the celebrated Lord Brougham ordered a carriage built by Mr. Robinson, a London coach-maker, after a design of his own invention, that has since borne his name, and become very popular with the aristocracy of England. This carriage, the combination of the coach and coupé, will seat two passengers comfortably on the back seat, and carry two children on a turn-down seat in front, under the circular glass inside.

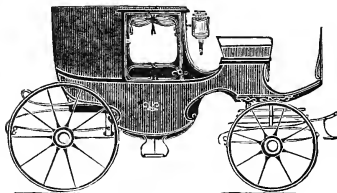

CLARENCE COACH.

The following year (1840) appeared a modified pattern of the coupé, with the ducal title of the *Clarence*, so called in honor of the duke of that name. These *Clarences* are widely different from an

ordinary coach, as will be seen by comparison, but are now nearly banished from the English catalogue. A late writer, in noticing this vehicle, captiously observes, that "whatever interest this souvenir of the past might have for antiquarians, it has none for us." Occasionally one may yet be seen in Hyde Park, but its place having long since been filled by improved and better designs, it is not likely again very soon to become popular in England.

The next carriage is called in England the *sovereign*. It came into use about the same time as the brougham. The lines in the body, although peculiar, are very far from being graceful. The designer evidently labored to produce something novel, in which he was successful, but in so doing seriously transgressed the laws of good taste.

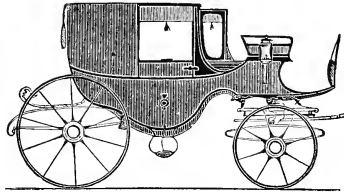

SOVEREIGN.

We now come to the *basterna coach*, after Mr. David Davies's pattern. This was invented in the year 1842. It differs but very little

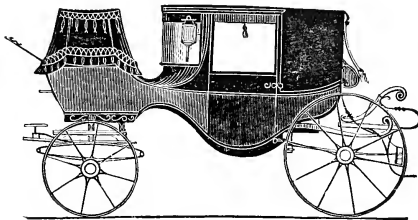

BASTERNA COACH.

from the charence, either in the construction of the body or arrangement of the dickey-seat. Here we discover one of the earliest examples of the rounded front, and the latest whereon is shown the ancient sword-case attached to the back panel. Al-

though this cannot be called a handsome vehicle, still it furnishes a pleasing variety in the British carriage nomenclature.¹

The following, from Knight's "London," may very appropriately be introduced here. He says, "It is very difficult to conceive of a London without an omnibus or a cabriolet. Yet who among us does not remember the hour when they first appeared? For some two hundred years

¹ *Basterna* is the Latin for sedan or close litter, drawn by animals, among the ancient Romans. We found the name on the drawing sent us from London.

those who rode in hired carriages had seen the hackney-coach passing through all phases of dirt and discomfort; the springs growing weaker, and the iron ladder by which we ascended into its rickety capaciousness more steep and more fragile, the straw litter filthier, the cushions more redolent of dismal smells, and the glass less air-tight. But it is of little consequence; nobody rides in them. The gentleman at the 'office for granting licenses for carriages plying for hire in the metropolis' tells us that licenses are still granted to four hundred hackney-coaches. Alas, how are the horses fed? Are the drivers living men, who eat beef and drink beer? We doubt if those huge capes ever descend to receive a fare. Are they not specter-coaches, — coachmen still doomed to sleep upon their boxes, as the wild huntsman was doomed to a demon-chase, for propitiation? The same authority tells us that there are fifteen hundred cabriolets to whom licenses are granted. These, we know, are things of life. They rush about the streets as rapid as fire-flies. They lame few, they kill fewer. They sometimes overturn, but their serious damage is not much. We borrowed them from the French, on a fine May morning in 1820. It is remarkable how slow we are in the adoption of a new thing, and how we hold to it when once it is adopted. In 1813 there were eleven hundred and fifty cabriolets upon the hackney-stands in Paris. — '*cabriolets de place*,' — and we had not one. Now we have fifteen hundred of them."¹

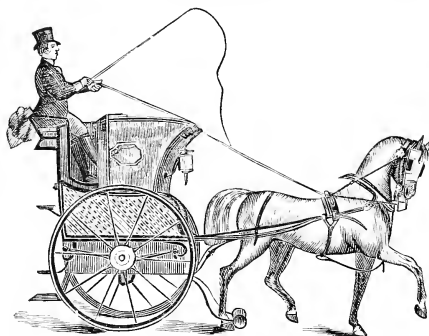

HARVEY'S CABRIOLET.

Early in the spring of 1844 a new cabriolet, under the name of *tribus*,² to carry three, was placed on the streets of London, for carrying passengers, patented by Mr. Harvey, of Lambeth House, Westminster Bridge road. The entrance to this vehicle is in the rear, as in the omnibus, so as to facilitate ingress and egress much

¹ See Knight's *Pictorial London*, 1841, Vol. I, p. 31.

² Two-wheeled, to carry three persons. See *Ill. London News*, March 2, 1844.

better than in the hansom. In case of accident, an escape may be more effectually accomplished than from its prototype. Here the driver sits at the rear, by which the vehicle with the fare is more equally adjusted to the back of the horse, besides giving him a complete command of the door, which he opens without leaving his seat. In front a red lamp was placed at night as a protection against collision. There was also a very novel and simple mode of communicating with the driver from the inside, more rapidly and conveniently than ever before in this class of vehicles. In addition, small wheels were placed in front to insure the safety of the occupants, in case the shafts should break, the horse stumble, or any other accident take place while the cab is in motion. This last arrangement is not of much use. Later in the same year, Mr. Okey invented a cab, which he called the *quartobus*, intended to carry four inside passengers. This hung on four wheels, the coupling being very close for easy draft.

In the summer of 1850, a unique little *pony phaeton* was built by Mr. Andrews, the Mayor of Southampton, for the Queen of England, which in France and America are now known as *Victorias*. The original announcement states that when the carriage was delivered in front of the palace in the Isle of Wight, "the Queen and Prince expressed to the Mayor their entire satisfaction with the style, elegance, extraordinary lightness, and construction of the carriage, which scarcely weighed three hundred-weight. The height of the fore wheels is only eighteen inches, and of the hind ones thirty inches. The phaeton is cane body, of George-the-Fourth style, with movable head; the fore part is iron, but very light



and elegant, and beautifully painted.”¹ This carriage has since been much improved in England and America, as will hereafter be seen. Other phaetons in England are known as the *alliance*, the *Moray*, the *Malvern*, the *mail*, the *Stanhope dog-cart*, the *sociable*, and the *sporting phaeton*, each differing in design from the other.

In the London Exhibition (1851) there were twenty-nine vehicles from subjects of Great Britain, from fourteen manufactories, but nothing especially new.² It was the complaint of the sub-jury that “the want of variety in the kind, and the absence particularly of the higher class of equipages, of traveling carriages, properly so called, and of vehicles intended for the public service,” the plain coach and vis-à-vis, and the landau and mail-coaches not being represented at all. This deficiency they attribute to the general introduction of railways in the kingdom. In the report, they continue:—

“Comparing the state of the art of carriage-building of former and not very distant times with that of the present, we consider the principles of building in many respects greatly improved, and particularly with reference to ‘lightness and a due regard to strength,’ which is evident in carriages of British make, and especially displayed in those contributed by the United States, where there is commonly employed, in the construction of wheels and other parts requiring ‘strength and lightness’ combined, a native wood (upland hickory) which is admirably adapted to the purpose. The carriages from the Continental states do not exhibit this useful feature in an equal degree.” Under the head of “elegance of design,” the jury note a great deficiency in the lines of the designs, which they charge to “injudicious innovation,” which requires the builders “to construct vehicles to convey the greatest number of persons,” in which it is not to be expected that “they can preserve those outlines which have hitherto been esteemed elegant and graceful.” They regret that this defect appears “in the higher class of carriages of pleasure and luxury, since they are exempt from the difficulty referred to,” which they hope to see in the future “governed by a nice

¹ See *Ill. London News*, Vol. XVI, p. 16. Some English manufacturers distinguish these phaetons as the “Queen’s Park phaeton” or the “Albert Park phaeton,” according to the finish or model of the body.

² The following statistics will interest the reader. At this time there were 16,590 coach-makers in England and its dependencies, 2,284 coach and cab owners, and 3,223 omnibus owners and conductors, and only 17 coach and carriage dealers.

discrimination, pure taste, and sound judgment." None of the carriages in the Exhibition was adjudged worthy of the council medal, and such was therefore withheld.

In 1859 the English had in use the *Elcho sociable landau*, the *waggonette*, the *Norway cart*, and various other new patterns of older vehicles. Some of these we intend to describe from the catalogue of an English firm, Messrs. Atkinson & Phillipson, Newcastle-on-Tyne.

The first is called a *shamrock dog-cart*, the seats made to slide so as to balance for two or four passengers, as required. These sit back to back, the feet of the hind sportsmen resting on the end-board, which, supported

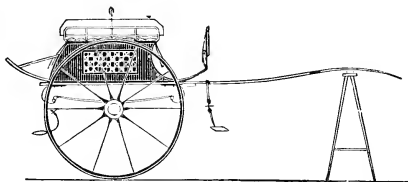

SHAMROCK DOG-CART.

by a strap, is let down, as in the engraving. The two-wheeled vehicles generally have shafts of lancewood, the timber of which, while it is elastic, preserves its original shape better than most woods. The openings in the side, of cane-work, supply air to the sportsmen's canine assistants, which are carried in the box.

The next vehicle is likewise called a dog-cart, although hung upon four wheels. Why a four-wheeled vehicle should be called a cart is one of the most singular things in the coach-makers' vocabulary, but

such is the fact, and we as historians must abide by it. We would call it a sporting phaeton, for such it is in reality. It is sometimes in England termed a Malvern phaeton. Like the previous vehicle, it is contrived to accommodate four passengers and the dogs. In England these are frequently finished with valentia cushions

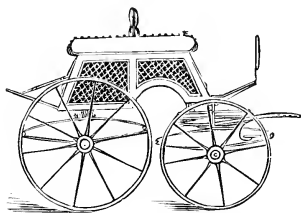

SPORTING PHAETON.

and falls, in a tasteful and costly manner, unknown among us, where they are held in less esteem. Although we might infer from the name that this vehicle was designed exclusively for sporting purposes, still such is not the case, it being frequently used as a pleasure-carriage in the public parks by both the nobility and gentry of England.

At the period of which we write, carriages in England were numer-

ous. The city of London police, in May, 1860, ascertained that 57,765 vehicles entered the metropolis every twenty-four hours, which, if drawn up close in line, would extend about two hundred and sixty miles, reaching from London to York, and extending more than fifty miles beyond the latter place. The closeness with which the vehicles follow each other in the streets may be inferred from the fact that between ten and eleven A. M., on Wednesday, the 19th of November, 1862, it was ascertained that the total number passing Bow Church, in both directions, was 1,255, of which 348 were omnibuses, 584 cabs, and 282 carts, drays, vans, and wagons, besides 41 trucks and barrows. The numbers and proportions of vehicles passing the same point between four and five P. M., on the same day, were ascertained to be as nearly as possible the same.

A London coach-builder, in a letter to the author in 1860, says in reference to trade, "Ten years have completed a total revolution in the carriage trade in England. Not only have the court and nobility adopted economical habits, and insist on cheap carriages, but they carry no luggage, as was formerly the case, when carriages had to sustain great weight, both of passengers and luggage. The cumbrous court carriages of former times are being gradually abolished, and instead of the rich linings, laces, fringes, and elaborate heraldry usual to the carriages of the nobility, light vehicles, furnished only with a crest, take many ladies of rank to the court of our gracious sovereign. The changes in construction, and consequent depreciation in stock, were a heavy blow to the master coach-builders; many of the large houses must have lost, in this manner, from ten to twenty thousand pounds. The trade having now recovered from this blow is in a more healthy state." The favorite carriages in England at this time were wagonettes, sociables, Stanhope and mail phaetons, basket phaetons, and landaus.

A second International Exhibition was held in London in 1862. An interval of eleven years occurs since the first took place. The jury's report tells us that "the tastes and requirements for private carriages have evidently, of late years, taken a great change. The English department does not contain a single carriage fitted with a hammer-cloth, although still used by the aristocracy during the London season. . . . Nor is there a traveling carriage, . . . nor carriages for the streets of cities and towns, because the choice of carriages for display had been left entirely to the discretion of each exhibitor. The

result was a lack of variety in the one hundred and forty in the building. We give a few extracts for the purpose of introducing some of the novelties, and increasing our collection of illustrations:—

“In consequence of many improvements effected in the manufacture of landaus, the chief of which is the great reduction in weight, the demand for them has already increased. They are well suited to the variable climate of the British Isles, as they can be readily changed from an open to a close carriage, and *vice versa*. They do not, however, admit of that beauty of outline that is capable of being given to an entirely open or entirely close carriage; but from the amount of care and contrivance displayed, as evinced in many of those shown, they have such qualities as render them very convenient and desirable family carriages, either for London or country use. There are shown several ingenious plans for enabling the heads of landaus to fall flatter than has hitherto been considered practicable; they have the advantage of converting the landau into a more open carriage than formerly, besides preventing an obstruction to the view. Most of these carriages are hung at such a very moderate distance from the ground, and with covered steps, that it is optional whether one or two servants shall accompany them.

“Carriages of the wagonette type, where the sitters in the back seats are placed sideways and vis-à-vis, are come much into use of late years. They possess the advantage of carrying a greater number of persons in a carriage

of given weight than any other on four wheels. The first, or nearly the first, of these was built in the year 1845, under the personal direction of the late Prince Consort, for the use of her Majesty and the royal family. It had many ingen-

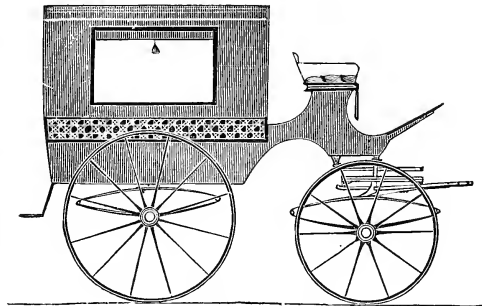

ENGLISH WAGONETTE.

ious contrivances suggested by the Prince, with whom and her Majesty it always remained a favorite carriage for country excursions. There

are so many varieties of carriages of this type, and so much ingenuity has been bestowed on them, that it can hardly excite surprise that they are much appreciated by those who use carriages, especially in hilly parts of the country, where a compact, serviceable, and economical carriage is in many cases indispensable.

"A revival of an almost obsolete carriage, 'the four-in-hand coach,' has taken place within a few years. They are generally built on the model of the best mail and stagecoaches of former times, but with a much higher degree of finish. It may appear very easy to the uninitiated to build such a carriage, merely on the lines of former days, but in fact they require such careful and accurate planning of the several parts, individually and combined, that only those who have given much attention to them, and have, to a certain extent, been tutored by gentlemen who drive them, have been successful in turning out carriages of the kind that in most points meet their requirements. . . . The revival of such taste for such carriages is worthy of remark, as the management of a 'team' not only requires great bodily strength, good nerve, and a quick eye, but, being an expensive amusement, is mostly confined to the aristocracy and persons of wealth, with whose habits it is principally associated, and indicates something of that vigor of body which generally distinguishes the British gentry."

"The principle of suspending carriages on a single wrought-iron perch, first prominently introduced at the Exhibition of 1851, has produced a great change in the construction of nearly all C-spring carriages now built, and has many advantages for small carriages hung low. It is, however, beyond a doubt, that for carriages hung high, and requiring double folding-steps, the perch of wood and iron combined has the greater recommendation of increased safety, as three iron plates and the wood must break before an accident can happen; whereas, the solid iron perch depends for its safety on the soundness of a single weld."

Some idea of the extent of trade in Scotland may be gathered from a statement in the Edinburgh "Daily Review," published in 1863, which says: "There are in Scotland 1,549 males and one female engaged in the carriage business, and 1,857 males and seven females in making harness." Persons in Great Britain at this period, letting post-horses and carriages, for a single horse and carriage paid an annual license of \$37.50, with seven rates to twenty horses and exceeding fifteen carriages, when the license was \$350, with \$50 for every ten horses, or

fraction thereof beyond. For the same in Ireland, \$10.50, and five per cent thereon. The license to run a stage-carriage in Great Britain was \$16, and to keep a hackney-carriage in London, \$5. In addition to the license for running stage-coaches, an additional duty of two cents per mile is levied. During 1862, 6,215 hackney-coaches were licensed in London, amounting to \$455,900. In Great Britain, 3,310 stage-carriages were licensed, amounting to \$632,090.

In London and a few other cities the hansom cab has proved very popular, a large number being worked by railway companies and others, involving large investments of capital to carry on the business. These vehicles are regularly numbered, licensed, and

put under the inspection of the police. A fair quality of horses are required to run them, with changes of drivers for both

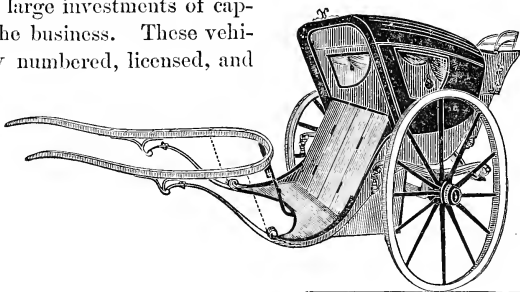

IMPROVED HANSOM CAB.¹

day and night service. Each horse and cab are lent to a cabman, who is expected to pay to the proprietor, at the end of his day or night work, a sum of 7s. 6d. or 8s., and this must be paid whether the driver has earned it or not, failure to do so rendering him liable to imprisonment. Most of the men who submit to this hard lot are such as have been unsuccessful in other pursuits of life, and adopt this as a last resource. For the most part, night cabs are inferior to those driven in the daytime, dilapidated and drawn by sorry-looking horses, the drivers of which would hardly pass muster under sunlight. Under the circumstances it could hardly be expected that men of character would engage in the business, and since they do not, the public has to submit to extortion and abuse of every kind.²

¹ This hansom shows the improvement of Mr. Evans. Cabs in London cost from forty-eight to fifty-four guineas.

² After all the praise bestowed upon the hansoms in certain quarters, we find, to our surprise, in a London journal for 1875, a notice that an influential company is in course of formation, for the purpose of supplying London with good cabs. The same paper

In consequence of the crowded condition of the streets during business hours, the following regulations for the city of London were adopted: Between the hours of nine A. M. and six P. M., no vehicle with more than four horses was allowed. Coals, beer, wine, or other liquids could not be delivered in twenty-four of the principal streets, except very early in the morning or after five in the evening. The sale of vegetables, fish, fruit, and other articles carried in any vehicle was likewise interdicted during the nine hours above alluded to. Wagons, too, were ordered to stand parallel with the curbstone while loading, with other regulations having the sole object in view of relieving overcrowded thoroughfares.

The next figure represents a *gentleman's family omnibus*, a thing unknown in America, or probably anywhere else except it be in Eng-

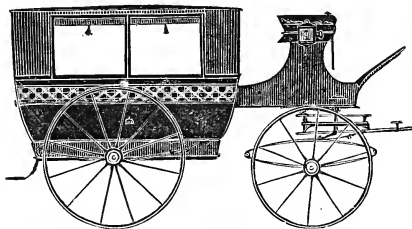

GENTLEMAN'S FAMILY OMNIBUS.

land and France. The body being hung low in a novel manner makes it easy of ascent. The body in some cases works in two recesses in the sides, when the sliding up and down of the axles must prove rather inconvenient to the passengers. The middle glass frames require to be fixed, and the glass opaque, to hide the operations of the wheels from the occupants when in motion, otherwise the sight might prove disagreeable and annoying.

complains of the treatment cabmen give their fares, and mentions that now and then cabmen may be met with who are honest, and adds, "But the only one we have encountered lately asked for a subscription to a Methodist chapel, as he amiably pocketed his exact fare. It is to be hoped that the Methodists will make more converts among the cabmen."

The most troublesome customer these "cabbies" have encountered lately is one Mrs. Giacometti Prodgers. Being well informed in law, she takes a seat in a cab, and should John charge a penny too much, she summons him before a magistrate. If there arises any doubt as to the distance traveled, she has it measured by government officials at her expense, and where she gains the suit the cabby is obliged to refund it, and pay a fine besides. The result of this "Prodgers" mission is that when a cabman sees that lady approaching his stand, he beats an ignominious retreat, and hides in one of the "shelters." But even there he is not certain of safety. On one occasion, it is said, she stormed a sanctum, when the affrighted Jehus fled in all directions, leaving her in undisputed possession of sundry uncooked chops, steaks, and half-emptied beer-pots.

The coupé we have shown to have originated in France. The following design exhibits an English type of the vehicle, after a design by J. Cooper, of London. This is hung up with elliptic springs in front, and half-elliptic and cross-springs behind. A peculiar feature in this carriage is, the lines of the body are mostly straight, the frieze or quarter rail being painted in imitation of wicker-work, formerly much in vogue among both Conti-

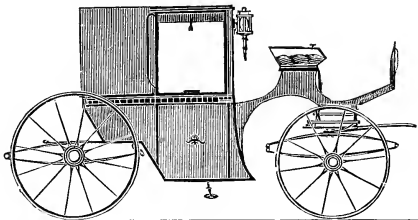

ENGLISH COUPÉ.

ental and English carriage manufacturers, as we have shown in the progress of this history. A comparison of this with the French (page 242) will furnish the reader with a very correct idea of the difference in taste applicable to similar vehicles constructed in the different countries.

We have previously shown a design (page 329) representing a barouche of the year 1767. The improvements of a century may be seen by comparing the *open town barouche* with the former. Adams describes the barouche as "the principal of all open carriages."

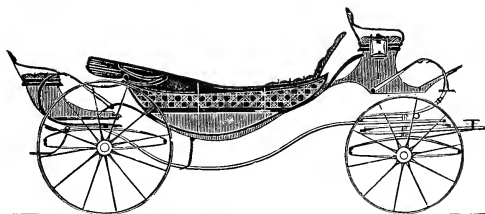

OPEN TOWN BAROUCHE.

As a carriage for park airings in summer weather it is unsurpassed, but for winter service the landau is preferable. The writer before mentioned says, "It is, properly speaking, only a town carriage, being unprovided with traveling furniture. The driving seat is similar to that of a landau." The rumble behind is designed for carrying a footman, the body and rumble both being suspended on C and under springs, rendering it extremely easy riding.

The largest export trade of England is with Australia, the Mauritius, India, British West Indies, Russia, South Africa, Brazil, Java, and Egypt, each country being mentioned according to its importance

from a commercial standpoint. In 1857 the pleasure and other carriages exported to foreign countries amounted to 1,564, the total value of which was £110,566; in 1858, 1,199, value £95,519; and in 1859, 1,195, value £95,744, — showing a decrease each successive year.

A writer in the "Carriage-Builders' Art Journal" gets off the following, which, after making the proper allowance for its extravagance, may be received as a picture of the times of which we write: "The occupants of 'London carriages' are not generally by any means devoid of their own attractiveness for beholders, nor are the horses unworthy their becoming share of attention; and the whole scene is so animated and so inspiring, and every actor appears so completely absorbed in doing either as much as possible or as little as possible within a given time and space," that "in no other city are such throngs on foot, or such crowds of carriages in motion. There may be greater gayety and more variety of costume in the streets of other cities, and the carriages may be more quaint and more remarkable; but there exists not elsewhere in the world what can for a moment be compared with the multitudinous array of London, with its surging yet quiet hosts of people, and with the quiet and unpretending costliness of its equipages. There is something thoroughly English and thoroughly London, also, as well in the heavily laden drays and good vans of the city, as in the best appointed sociable landau that dashes into the Park between other carriages that have their panels coroneted like its own. And all this may be made to feel effectively upon our particular object, upon the carriage-building of England at the present. It is this carriage-building which produces these carriages; let the carriages collectively react for good upon the manufacture which brings them into effective and characteristic existence. And more than this, the carriages of London may be made powerfully instrumental in exercising practical influence upon the provincial trade and upon carriage-building throughout our colonial empire. London is and London must be the model workshop of the British Empire; and the streets of London constitute the London carriage-builders' museum of productions. From this museum provincial and colonial purchasers and users of carriages alike derive their prevalent ideas of what they like and what they will pay for."

With the *Elcho sociable landau*, introduced by Rigby and Robinson, of Park Lane, London, we close the illustrations of this chapter. An

English authority says, "Its graceful outline and roominess make it the very beau-ideal of vehicular luxury. It has become what the dress chariot was some years ago, the handsomest C-spring carriage out."

There is no people in the world who use carriages for display as well as pleasure, that can compete with the English. The thirty millions of human beings which crowd the little island have, either by force or skill, laid nearly every country on the globe under contribution. Her aristocracy possess the most superb horses and the most beautiful equipages, attended by servants dressed in showy liveries, such as are seen nowhere else. On almost any afternoon during "the London season," files of carriages, often four abreast, each a mile or more in length, may be seen in Hyde Park, moving in a certain direction with the greatest regularity, all under police control. As evidence of this we will state that on one fine afternoon in June, 1873, when the Shah of Persia was expected to enter it, on his way to Windsor, the writer, with a miscellaneous crowd of other plebeians, took his station on the foot-curb next the street, inside. Soon after the carriages stopped in front, obscuring the view, much to our annoyance. It was not long, however, before a squad of mounted police made its appearance, forcing the entire line across the roadway, leaving the standing visitors an unobscured view of the procession, which included the Prince and Princess of Wales, the Hon. W. E. Gladstone, and other dignitaries. It certainly gave us much pleasure to find that, with all her pride and aristocratic feeling, there still remained some sense of right for the common people, which the rich were forced to respect.

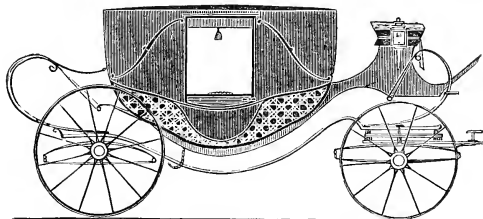

ELCHO SOCIABLE LANDAU.



NORTHERN EUROPEAN CARRIAGES. — RUSSIA, NORWAY, DENMARK,
SWEDEN, AND GERMANY.

In northern climes, where frost and snow abound,
And half the year seal up the fertile ground,
Then wheeled vehicles are laid aside,
And only sledges capture those who ride.

AUTHOR.

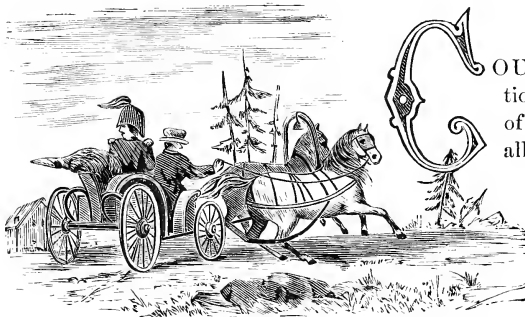

COUNTRIES mentioned at the head of this chapter have all, more or less, in modern times, copied the models of France and England in building their carriages. These

we need not notice here. There are, however, some vehicles peculiarly national, deserving of special notice, such, for instance, as the Russian *droschke* and the Norwegian *cariole*, etc. The Russian carriages, in addition to the one named, are the *kibitka*, the *taranta*, the *telega*, and the *telashka*, with a few others.

The *droschke*, engraved at the beginning of this chapter, is much used, both for public and private purposes, during the summer months, particularly in St. Petersburg and Moscow. As soon as winter sets in and snow falls, both *droschkes* and sledges may be seen clustered together along the footways for hire; but as winter advances, the wheel carriages disappear until spring opens. Before the invention of springs, the *droschke* was an uncomfortable machine, one writer describing it "altogether as ingenious an instrument of torture as any exhibited in the Tower of London, or elsewhere." The passengers'

seat has been described as an oval-cushioned affair, extending along the center of the body, from the driver's seat to the back end, without a rest-board, on which single travelers sit astride in the most inelegant manner, the only prospect ahead being a needlessly close view of a long coat of coarse cloth, with a brass plate and number suspended from the collar, the whole surmounted by a low-crowned hat, in shape resembling a peck measure. When there are two passengers, one sits in advance of the other, with their feet on opposite sides, resting on a step-floor, to which the fenders are secured, which extend upwards in graceful curves over the wheels, the driver being seated in front, separated from his fare by an iron bar, six inches high. All the drivers have a common livery, consisting of a blue coat, folding over the breast, secured at the waist by a sash, the skirts hanging a little below the knees. They have trousers of large size, tucked inside the boots, coming half-way up the legs. A long, shaggy beard completes — the driver.

Thus situated, the driver starts his horses, keeping on at a good run ; and could you hold on to the droschke with your feet as tightly as you hold on to your companion with your arms, you might feel a measure of security. Indeed, we are told, "if you are driving on the Nievsky Prospect, and it is crowded with other vehicles, the greater number of them droschkes, all running as fast as your own, — now you put out your hand to turn away a running horse's head within a foot of your own face, and directly your other shoulder wipes the foam from another passing horse, and this is done so often that your outside garment soon looks like a winter landscape. For observation you have no time, your whole attention being occupied in wondering at the skill with which imminent collisions are dodged, and when at last you become used to it, think it the finest driving you ever enjoyed."

The bow-shaped fixture over the neck of the horse serves to keep the shafts apart, support the reins, and elevate the head. Sometimes this bow is three or four feet high. For drags it is often three inches thick and five wide, painted with gaudy colors, as a wreath of red roses on a ground of green grass. When three horses are used, they are all harnessed abreast. The horses are mostly black, and it is said they seldom fall. There is a tariff of charges for the public droschkes, regulated by law, but avoided where possible. If you hire one and give the driver his orders, he invariably tells you he is already engaged, and

cannot consent to run the risk of being discharged for a less consideration than three half-rubles, which you are compelled to pay, or "foot it."

The kibitka is the common posting-wagon, consisting of a huge frame of unhewn sticks, fastened firmly upon two axles, the fore part of it having underneath a solid block of hard wood, on which it rests, elevating it so as to allow the wheels to play. A simple mode of forming a seat is to take a long rope, and cross it many times over the top of the frame, securing it to the frame-work at the sides, thus providing a seat which is a little elastic, in the absence of springs, in which they are deficient. Sometimes this improvised seat is improved by adding a pillow or a sack of hay. By being thus elevated, the unaccustomed traveler is likely to be thrown out; thus, while in one sense he enjoys a degree of comfort, he, on the other hand, is made miserable by the fear of being killed.

The taranta is the traveling-carriage of Russia, accommodated to the miserable roads in many portions of the empire. The body resembles a flat-bottomed punt, placed upon a series of long poles, connecting the axles of the front and hind wheels. A hood and apron protects the passenger from the rain. In this carriage the baggage is securely packed, sitting on which the traveler finds some comfort by day, reclining on which he sleeps at night. Three horses before the vehicle constitute it a troika.

At St. Petersburg there is an imperial manufactory for carriages, with an Englishman as director, also a museum of old vehicles, fully described in the "New York Coach-maker's Magazine." Russian carriages of every description are built in the most solid manner, as the thaw in the spring, after the winter frosts, renders the roads so bad that a light or weak carriage must soon give out.

The most ancient wheeled vehicle in Norway is the cariole, resembling very much the Laplander's sledge on wheels. One more than two hundred years old was shown in our late Centennial Exhibition. When formerly it had no springs, the shafts were made very long, to give it a degree of easy motion. Since the introduction of springs this length has been a little shortened, although still unsightly long in the opinion of many. Usually only one passenger occupies the narrow seat over the wheels, which are generally large sized. The hind portion has a fixture for carrying baggage, on which in some cases a

second passenger takes a seat. The harness is generally very simple, very much resembling a cart harness, although somewhat lighter, the reins being made of rope.

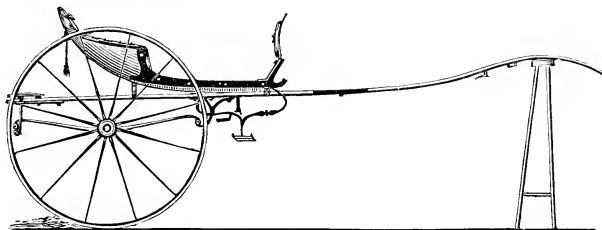

NORWEGIAN CARIOLE.

"The carioles," says Mr. Barrow, a traveler in Norway, "were generally accompanied either by boys, who ran alongside with extraordinary activity, jumping up occasionally behind to rest themselves, whenever the road was tolerably level; but as the country on the first part of our journey was ascending, sometimes up the steep side of the mountain, they often had to walk the greater part of the stage. . . . The traveler is surrounded on all sides by rocks of enormous height, rising almost perpendicularly from their base, while the sides of the mountains are covered with forests of dark green fir-trees, which rear their lofty heads above each other, vying in height with the steep rocks among which they are blended. The precipices both above and below the narrow road are frightful to contemplate, no precaution whatever being taken to prevent carriages from slipping off into the abyss below. In many places these precipices are perpendicular, and sometimes are inclined inwards. The road, too, is so narrow as to be little more than barely sufficient to admit the wheels of carioles between the edge and the sides of the mountain. Had we happened to meet any other travelers here, — which, was fortunately not very probable, — we should have been under the necessity of taking the horses out, and lifting the carioles over each other. The chances, however, were against such a meeting, for not a single human being had hitherto appeared to us on this route. Oftentimes the road before us seemed to terminate altogether at the brink of the precipice, when on reaching the spot it was found to turn sharply round; and then sharp turns, with the yawning gulf beneath, being almost inevitable destruction, should the animal

become restive, or an overturn unfortunately take place." Like most other northern European vehicles, these carioles are made heavy and strong.

The Danes have an open carriage known as the *Holstein-vogue*, or traveling-wagon, which is used for long journeys, more on account of its cheapness than for any other reason, as it has neither covering nor springs. Visitors willing to pay are furnished with a superior vehicle, to which a covering is added.

At the end of the nineteenth century there was only one coach in Sweden, and that was taken there by John of Finland, on his return from a visit to England.¹ Fifty years ago there were no stage-coaches in the country, and travelers had to provide their own carriages, or else employ such rude machines as it afforded, of rude construction, but answering very well in fair weather. The native horses are represented as small, but active and sure-footed. The harness consisted of little else than common rope, adjusted to the animal in a very primitive manner, as in other undeveloped lands.

To notice all German vehicles would oblige us to duplicate much of the matter given in the chapter devoted to France. Consequently we limit our remarks to a few of the more ancient carriages, and begin

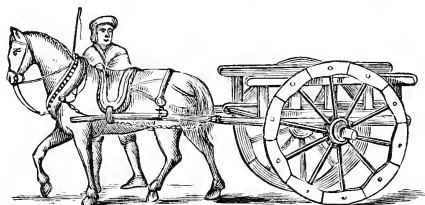

GERMAN KAREN.

with the German *karen*, or cart, of 1508, copied from a wood-cut by Hans Burgmayer. Similar pictures, drawn by Albert Durer, the teacher of Hans Burgmayer, are still in existence, the construction of which almost exactly

agrees with some of the present time among the Germans and other neighboring nations.

The next engraving represents the vehicle used on the wedding-day of William, Duke of Bavaria, with Benata, Duchess of Lothringen, in 1568. It was presented to the bride by the bridegroom as a bridal and family carriage. It is copied from a volume in the private library of the head table-master of a public institution in Munich. A peculiar

¹ See Dalin's *Geschichte des reichs Schweden übersetz von Dahmert*, III, I, pp. 390, 402.

ilarity of this carriage is that the body is suspended on leather braces to standards, as we find in the French department. The carriage itself has been immortalized in verse by the German poet Wirre, in a

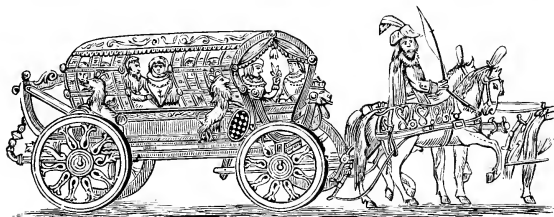

DUCHESS OF LOTHRINGEN'S COACH.

volume published at Augsburg, the year of the marriage, wherein he labors carefully to describe the skillful manipulations of the carriage-maker, carver, blacksmith, painter, and goldsmith.

CHAPTER XI.

AMERICAN CARRIAGES, WITH THEIR HISTORICAL ASSOCIATIONS.

“Now in building of chaises, I tell you what,
 There is always somewhere a weakest spot,
 In hub, tire, felloe, in spring, or thill,
 In panel, or cross-bar, or floor, or sill,
 In screw, bolt, thorough-brace — lurking still.
 Find it somewhere you must and will —
 Above or below, or within or without —
 And that’s the reason, beyond a doubt,
 A chaise breaks down, but does n’t wear out.”

O. W. HOLMES, *One-horse Shay.*

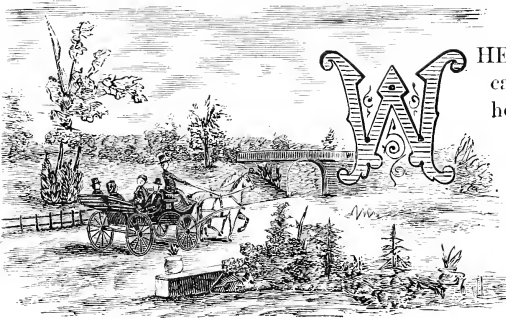

WHEN our forefathers came to this western hemisphere, they found it a vast wilderness, inhabited by a horde of savages, with “untutored minds,” the victims of ignorance and superstition. It is,

however, certain that some of the more advanced Indian tribes of the South were supplied with litters of some sort, which they used on special occasions, although of very rude construction.¹ These, however, were unsuited to the exigencies of a people that had been accustomed to the refinements of civilized life in a quarter of the globe where wheeled vehicles were in use, both for business and pleasure. As was to be expected, the early colonists, being necessitous, could

¹ When (in 1592) Columbus visited Hispaniola (now Hayti), the young cacique met him at an interview, borne in a litter by four men. (Irving’s *Life and Voyages of Christopher Columbus*, Vol. I, ch. 7, p. 225.)

spare but little time in gratifying the senses, consequently on landing the first care was to make provision for the body, to secure which the forests must be leveled, the grounds broken up, and the seeds thrust in, to insure the future harvest.¹ To accomplish this the more readily, the services of the wheelwright were required. Accordingly, among the earliest instructions of the company in England to Gov. Endicott and his Council, in founding the Colony of Massachusetts Bay, we find in the list of artisans sent over in 1629 "there is one Richard Ewstead, a wheelwright, who was commended to us by Mr. Davenport for a very able man, though not without his imperfections. We pray you take notice of him, and regard him as he shall well deserve. The benefit of his labor is to be two thirds for the general Company, and one third for Mr. [Matthew] Cradock, our Governor, being his charges is to be borne according to that proportion; and withal, we pray you take care that their charges who are for partable employments, whether in halves or thirds, may be equally defrayed by such as are to have the benefit of their labors, according to each party's proportion. Their several agreements, or the copies thereof, shall be (if God permit) sent you by the next ships."²

In May of the same year (1629), we learn from the company's second letter to Governor Endicott, that "Richard Claydon, a wheelwright recommended unto us by Dr. Wells, to be both a good and painful workman, and of an orderly life and conversation, our desire is, that upon all occasions he may have your furtherance and good accommodation, as you shall find him by his endeavors to deserve; to whom, as to all others of fitness and judgment, let some of our servants be committed, to be instructed by him or them in their several arts," etc.³

The men whose names we have mentioned were unquestionably among the first wheelwrights sent to this country, whose usefulness in

¹ An episode in the early history of New England proves this fact, for Captain Cromwell, who, as privateer in the West Indies, among other goods, captured a sedan that had been sent by the Viceroy of Mexico to a lady, his sister, which he (the captain) afterwards gave to Governor John Winthrop. This sedan, the governor tells us, "he had no use for," and it was subsequently handed over to D. Anhay, an officer in his Majesty's fleet, on his visit to Boston in 1646. (Winthrop's *History of New England*, Vol. II, pp. 323-335.)

² Young's *Chronicles of the First Planters of the Colony of Massachusetts Bay*, p. 165.

³ Young's *Chronicles of the First Planters of the Colony of Massachusetts Bay*, p. 177.

supplying the colonists with carts, wagons, and the implements required in cultivating the soil will not be disputed. From such small beginnings, as the sequel will show, has art progressed in America, that now we may boldly challenge the world to excel us, either in lightness, gracefulness, or durability, when applied to carriage manufacture. Although we have borrowed many improvements from Europeans, yet we have invented many entirely our own, thus imparting to our vehicular nomenclature a specially distinctive American character. Indeed, a large number of our pleasure carriages have no counterpart in any other land.

While this country was a dependency of Great Britain, no carriages of any note were manufactured here, and but few used. There was, to be sure, now and then, one to be found among the wealthy English families settled in Boston¹ and the vicinity; unwieldy and cumbrous indeed, emblazoned with family crests on the panels, and set off with characteristic gewgaws and finery, attended in their movements by importations of liveried menials, whose presence rendered them odious in the eyes and abhorrent to the feelings of the less wealthy and plainer class of people. In Virginia, too, some of these "gentry," in the earlier days of its history, showed themselves off in their European coaches, to the amazement of their neighbors. Indeed, those who rode and those that "footed it" were members of distinct classes — plebeian and aristocratic — until the days of the Revolution. When the Rev. Thomas Hooker, in 1636, traveled inland from Newton, Massachusetts, to Hartford, Connecticut, with a few colonists, such was the scarcity of suitable wheeled vehicles, that his wife, who was an invalid, had to be carried the entire route in a horse-litter. Even more than forty years had flown before a monthly post was started between Boston and New York City, by the provincial governor, Lovelace (Jan. 1, 1673), so limited were the requirements of commerce.

Three years later (1676) there were only twenty "car-men" in the city of New York, and against these stringent laws were enacted, after

¹ Coaches appear to have been introduced into Boston about the year 1669. At the funeral of the Hon. William Taibor (lieutenant-governor of Massachusetts under England), there was in attendance "a great number of gentry in their coaches, chaises, etc., and an abundance of spectators." (See *The Boston News Letter* for March 9, 1732.) We have seen it stated in *Harper's Weekly*, that the first coach or private carriage imported into America was in 1770, by Lindley Murray, the father of the eminent grammarian. It will appear, as we proceed with this history, that the above is a mistake.

being enrolled. They were ordered for 6*d.* to draw an ordinary load, and for 3*d.* per load weekly to remove from the city the dirt collected in the streets. The "dustmen" getting angry in consequence, the cartmen refused to comply with the ordinance, when the "Scout [sheriffs] Burgomeesters and Schepens" forthwith "dismayed" the entire body by divesting all of their licenses who should not appear as usual at the public dock, pay a fine, and make their submission. Only two succumbed, and the rest were enjoined from further business. So late as 1784, carts were not allowed to have any tires on the wheels, for fear of injuring the streets.

The first post-route between New York City and Philadelphia appears to have been established in 1693, when the mails went through once in a fortnight. Such was the ill condition of the road that twelve years afterwards (1705) it is recorded, "The Philadelphia post is not yet come in [at New York]; it is supposed that the three days of rainy weather has hindered him."

At the beginning of the last century, when, according to Watson, a hack had not yet been heard of, there were some two or three coaches in use in Philadelphia. William Penn, the founder of the city, says in a note to James Logan, written in 1700, "Let John [his black] have the coach and horses put in it, for Pennsburg from the city."¹ In another letter he mentions his "calash," and requests the justices to have bridges built over the Pennepack and other streams, for his carriage to pass over. James Reed, a very aged gentleman, who died about one hundred years later, said he could well remember when there were only eight four-wheeled carriages kept in all the Province.

Five of these were coaches, belonging respectively to the governor (Gordon), Jonathan Dickinson, Isaac Norris, Andrew Hamilton, and Anthony Palmer; and three four-wheeled chairs, owned by James Logan, of Stenton, David Lloyd, of Chester, and Lawrence Growden, of Bucks. Under the unostentatious government of Penn and his immediate successors, a carriage was not deemed a necessary appendage, either of wealth or respectability. Merchants and professional gentlemen were quite content to keep a one-horse chair. These had none of the present trappings of silver plate, nor were the bodies varnished; plain paint alone adorned them, and brass rings and buckles

¹ We are indebted to Watson's *Annals of Philadelphia* for some of these facts.

were all the ornaments found on the harness ; the chairs (chaises) were without springs, and leather straps (thorough-braces), such as could now be made for fifty dollars, served instead.

As early as 1697 there was one John Clapp, who appears to have been innkeeper, poet, and wag, living in the Bowery, "two miles from the post-office," which was then considered far out of town. In an old almanac, printed by Bradford,¹ among other curious things we are told, "It is now one year since the first hackney-coach was made and kept in this city, by John Clapp, for the accommodation of all Persons desirous to hire the same. From the Post-office in New York to Jo. Clapp's in the Bowery, is two miles (which generally is the bating-place where gentlemen take leave of their Friends, going so long a journey), and where a parting glass or two of generous wine,

If well apply'd, makes their dull Horses feel
One spur i' th' Head is worth two in the Heel."

No physician in these primitive times visited his patients in a carriage, as they now do ; all had "to foot it."²

In the same year, while Clapp was running his "hack" (Dec. 22, 1697), an ordinance was passed in Albany, New York, in which "it is Proclaimed y^t all Persons who enter y^e City with slees [sleighs] and horses, horseback or oyrwise [otherwise], shall not ride faster than foot-tap throughout y^e streets, upon Penalty of three shillings for each offence." Two years afterwards, "It is further Resolved and thought convenient that a Proclamation be proclaimed, y^t no Carmen shall hereafter use a Cart until such time they have Mr. Mayor's Lycence therefore, upon Penalty of forfeiting y^e somme of six shillings, and y^t no person or persons shall drive there horse or horses in slees or oyrwise through y^e streets of this City faster than upon a stap, upon penalty of forfeiting y^e somme of three shillings, *toties quoties*." It might interest us did we know exactly what effect these municipal ordinances had upon the sturdy Knickerbockers of the sixteenth century, — whether they were enforced or not.

¹ William Bradford was one of the earliest printers in America. He began business first in Philadelphia, afterwards removing to New York, where he died in 1752, at the age of ninety-four. A monument erected to his memory is still standing in Trinity churchyard.

² See Valentine's *Manual of the Common Council of New York*, for 1853, p. 456.

The Philadelphia "Weekly Mercury" notifies its readers that "The Post sets out from *New York* and *Boston* the 14th Day of this Instant *March* [1719], and are to perform these Stages Weekly till *December* next. Which alteration of the Post will occasion this News Paper to come forth every *Thursday*, on which day the Post sets out from Philadelphia."

The same paper (Nov. 30, 1732) says, "On *Monday* next the Northern Post sets out from *New York*, in order to perform his stage but once a Fortnight, during the Winter Quarter; the Southern Post changes also, which will cause this Paper to come out on *Tuesdays* during that Time. The Colds which have infested the Northern Colonies have also been troublesome here, few Families having escaped the same, several have been carry'd off by the Cold, among whom was *David Brinnail*, in the 77th. Year of his Age, he was the first Man that had a Brick House in the City of *Philadelphia*, and was much esteem'd for his just and upright dealing. There goes a Report here, that the Lord *Baltimore* and his Lady are arrived in *Maryland*, but the Southern Post being not yet come in, the said Report wants Confirmation."

In 1709 the posts which stood along the walks "of the Broadway" were ordered removed, as being unsightly, and no longer eligible for tying horses. It was nearly thirty years later (1738) before the first coach made its appearance in the "Empire City." This was owned by Governor John Montgomerie, together with a fine set of harness. Besides this he kept a four-wheeled chaise, for which another set of harness was provided, and likewise an elegant servant's saddle.¹

Miss Sarah Knight, a Boston lady who visited New York City in 1704, tells us, "Their Diversions in the Winter is Riding Sleys about three or four Miles out of Town, where they have houses of entertainment at a place called the Bowery, and some go to friend's Houses, who handsomely treat them. Mr. BURROUGHS carry'd his spouse and

¹ Such was the poverty of many kinds of business in the early days of our history, that we find there were some "jacks of all trades." One Judith Vincent advertises in the *New York Gazette*, under date of May 1, 1736, "An Indian servant named Stoffels, who is a house-carpenter, cooper, *wheel-wright*, and is a good butcher, also, who is supposed to have escaped in a *canow* towards Connecticut or Rhode Island." We have somewhere read that Lady Murray owned the first coach in New York (in 1745), but if our record is correct, such a statement cannot be true.

Daughter and myself out to one Madame DOWES, a Gentlewoman that lived at a farm House, who gave us a handsome entertainment of five or six Dishes and choice Beer and metheglin, Cyder, &c., all which shee said was the produce of her farm. I believe we mett fifty or sixty sleys that day; they fly with great swiftness, and some are so furious that they'll turn out of the path for none except a Loaden Cart."

Thirty years after John Clapp entered upon the hack business in New York, one Mr. Skelton—as we learn from the "Pennsylvania Gazette"—informed the citizens by advertisement that he had "a four-wheeled chaise in Chestnut street [Philadelphia] to be hired." The terms were "for four persons to Germantown, 12 shillings and 6 pence; to Frankford, 10 shillings, and to Gray's Ferry, 7 shillings and 6 pence to 10 shillings."

The earliest practical wheelwright who located in New York City was a Scotchman named William Campbell, an emigrant from Isla, who was induced to cross the ocean in 1738 by the offer of a free grant of land from the Province, then a dependency of England. This man died here in 1763.

It is evident that at this time there were not sufficient skilled workmen in the country to supply the demand, consequently both chaises and horses had to be imported from abroad. Doctor William Shippen, who practiced in Philadelphia in 1745, writes to George Barney (celebrated for procuring good horses), saying, "I want a genteel carriage-horse of about fifteen hands high, round bodied, full of courage, close ribbed, dark chestnut, not a swift pacer, if that must enhance his price. I much like the pacer you procured for James Logan," previously mentioned.¹ A few years later (1751) the doctor writes to John Good-

¹ In the olden time, the horses most esteemed were pacers. To this end the breed was propagated with care, and pace racers were held in preference. The Narragansett racers of Rhode Island were in such repute that they were sent for at much trouble and expense by some few who were choice in their selections. It may amuse the present generation to peruse the history of one such horse, spoken of in a letter of the celebrated Rip Van Dam, who (1731) was president of the Council, and on the death of Gov. Montgomerie was *ex officio* governor of New York. The letter under date (1711) is addressed to Jonathan Dickinson, of Philadelphia. He recounts the difficulties he had encountered in procuring a horse. It had been shipped on a sloop at Rhode Island, and on the passage it jumped overboard and swam to its former home. Afterward it was reshipped, and after a fourteen days' passage it reached New York, much reduced in flesh and spirit. This horse cost £32, and the freight fifty shillings. From New York he was sent inland to Philadelphia "by the next post," *i. e.*, postman. It is shown

man, of London, discouraging him from sending out two chairs or chaises, saying that trade was dull in Philadelphia. Unquestionably these chaises were of the English gig class (page 319), very popular in that country at the period of which we are writing.

In 1746 one Abram Carpenter, a cooper in Dock Street, Philadelphia, "near the Golden Flag," advises the public that he has two chairs and some saddle-horses for hire, in doggerel, as follows:—

" Two handsome chairs,
With very good geers,
With horses or without,
To carry friends about,

Likewise saddle-horses, if gentlemen please,
To carry them handsomely, much at their ease,
Is to be hired by Abram Carpenter, cooper,
Well known as a very good cask-hooper."

The following items in the character of advertisements are copied from "The New York Gazette, revived in the Weekly Post Boy," and are of interest here. The first is dated Nov. 16, 1747, reading thus: "To be sold a handsome Coach and Harness, with all the apurtenances thereunto belonging. Enquire of George Burnet near Coenties Market." The next, under date of March 6, 1749, informs us that there was "stolen out of His Excellency's Coach, last Wednesday night between 12 and 1 o'clock, two whitish Cloth Cushions, lac'd round the seams with worsted Lace of the same colour (from the Broad-Way near the Post-Office). Whoever can give Information thereof shall be rewarded, and if not returned soon *Twenty Shillings* Reward and no Questions ask'd by Nathaniel Lawrence."

The third, dated Jan. 22, 1750, lets us know that "Chaise Boxes, Chair and Kittereen Boxes, with all sorts of Wheels and Carriages for the same, are made by James Hallett, on Golden Hill, at the sign of the *Chair Wheel*, at the most reasonable Rates, with all Expedition."

Again we read under date of April 22, 1752, "James Hallet, Wheelwright, at the sign of the Riding-Chair, near the *Spring Garden*, in the Broad-way, makes and mends all sorts of Wheels; such as Coach,

in the letter that the same post-rider rode the entire route from city to city on horseback. We are told of *the pacer* that he is no beauty, "although so high-priced," save in his legs; he will never stand still, always plays and acts, will take a glass of wine, beer, or cider, and probably would drink a dram in a cold morning. — WATSON'S *Annals of Philadelphia*.

Chariot, Chaise, and Chair Wheels; likewise Kittereen and Chair Boxes; also Waggon and Carts, after the best Manner, with great Care and Expedition, at the most reasonable Rates."

How the old New-Yorkers amused themselves is thus told by the Rev. Mr. Burnaby, who visited the city in 1750: "There are several houses pleasantly situated up the East River, near New York, where it is common to have turtle feasts. These happen once or twice a week. Thirty or forty gentlemen and ladies meet and dine together; drink tea in the afternoon; fish and amuse themselves till evening, and then return home in Italian chaises (the fashionable carriage in this part of America), a gentleman and lady in each chaise." At this time these chaises were so numerous that, according to a notice in the "New York Gazette," there were upwards of seventy chairs and chaises at a horse-race on Hempstead Plains, Long Island, from New York City alone. It was computed at the time that more than a thousand horses crowded the ferry to Brooklyn on that occasion.

From Mear's "Picture of Philadelphia," we learn that in 1752 an accurate list was taken of the names of every citizen who kept a four-wheeled chaise of any kind, from which it appeared that thirty-seven was the whole number. Single-horse chaises were more numerous.

The "Philadelphia and Perth-Amboy stages" are thus advertised in the "Pennsylvania Journal," under date of Nov. 6, 1756: "NOTICE is hereby given, that we the subscribers, John Butler, of Philadelphia, at the Sign of the Death of the Fox, in Strawberry Alley, begins his Stage on Tuesday, the Ninth of this Instant November, from his House and will proceed with his Waggon to the House of Nathaniel Parker, at Trenton Ferry; and from thence the Goods and Passengers to be carried over the Ferry to the House kept by George Moschel, where Francis Holman will meet the above John Butler, and exchange their Passengers, &c., and then proceed on Wednesday throughout Princetown and New-Brunswick, to the House of Obadiah Airies, in Perth-Amboy, where will be a good Boat, with all Conveniences necessary, kept by John Thomson and William Waller, for the Reception of Passengers, &c., who will proceed on Thursday Morning, without Delay, for New-York, and there land at Whitehall, where the said Waller and Thomson will give Attendance at the House of Abraham Bockeys, until Monday Morning following, and then will return to Perth-Amboy, where Francis Holman on Tuesday Morning following will attend, and

return with his Waggon to Trenton Ferry to meet John Butler, of Philadelphia, and there exchange their Passengers, &c., for New York and Philadelphia.

"It is hoped that as these Stages are attended with a considerable Expense, for the better accommodating Passengers, that they will merit the Favours of the Publick; and whoever will be pleased to favour them with their Custom, shall be kindly used, and have due Attendance given them by their humble servants, JOHN BUTLER, FRANCIS HOLMAN, JOHN THOMSON, and WILLIAM WALLER."

The "Bordentown Stage *Continued*," which appears to have had some opposition, is thus advertised in the Philadelphia "Weekly Mercury," in 1757: "Joseph Borden's stage boat, Joseph Canida master, attends at the crooked-billet wharf every monday and tuesday, and his shallop, Daniel Harrison Master at the same place every friday and saturday, stage waggons attends the said boats the stage boats at Amboy commanded by Aaron Edward. As to the owners of the Burlington stage boasting of their advantages being superior to mine, I shall not take the trouble to make reply too, because the publick by this time is the best judges of our stages and their advantages, only shall just note the last clause of their advertisement, that is, they say we are one tide more upon the water, than they are, which in fact is saying we are always two tides upon our passage. Well done brother adventurers, that is a large one. All gentlemen and ladies that please to favor me with their business, may depend upon the utmost care and dispatch of their humble servant JOSEPH BORDEN."

The "Pennsylvania Journal" for the same year advertises: "Whereas the Stage Boats employ'd between *Philadelphia* and *New York* are found very advantageous to the Public. Therefore the Subscribers have erected a Stage from *Philadelphia* to *Annapolis* in *Maryland* for which Purpose *Jonathan Jordan* sets off from *Loyd's Wharf* every Saturday and proceeds to *Frederick Town* to a Stage Boat which proceeds to *Annapolis* and to continue weekly. And as this undertaking will be considerably expensive it is hoped the Public will give it proper Encouragement and it shall be performed at moderate Rates by JOHN HUGHES and Comp. N. B. The Land Carriage is 21 Miles and the said *Jordan* leaves *Reedy Island* on Tuesday's."

The enterprising John Butler, who, as we have seen, in company with three others, ran the Philadelphia and Perth-Amboy stages, two years

later (1758) advertises in the "Weekly Mercury" that his "Philadelphia Stage Waggon and New York Stage Boat perform their Stages twice a week," according to the following programme: "John Butler, with his waggon sets out on Mondays from his House, at the Sign of the Death of the Fox, in Strawberry ally, and drives the same day to Trenton Ferry, when Francis Holman meets him and proceeds on Tuesday to Brunswick, and the passengers and goods being shifted into the waggon of Isaac Fitzrandolph he takes them to the New Blazing Star to Jacob Fitzrandolph's the same day, where Rubin Fitzrandolph, with a boat well suted, will receive them, and take them to New York that night. John Butler returning to Philadelphia on Tuesday with the passengers and goods delivered to him by Francis Holman, will again set out for Trenton Ferry on Thursday, and Francis Holman, &c., will carry his passengers and goods, with the same expedition as above to New-York."

We have shown that a mail route had been established between New York and Philadelphia in 1693. It is on record that as late as 1730 "the post was performed to Albany from New York on foot." But matters improve. We find in the "New York Gazette" that the "Flying Machine kept by John Mercereau, at the New Blazing Star Ferry near New York, sets off from Powles Hook every Monday, Wednesday, and Friday Mornings, for Philadelphia, and performs the Journey in a Day and a Half, for the Summer season, till the 1st of November, from that Time to go twice a Week till the first of May, when they again perform it three Times a Week. When the Stages go only twice a Week, they set off Mondays and Thursdays. The Waggons in Philadelphia set out from the Sign of the George, in Second-street, the same Morning. The Passengers are desired to cross the Ferry the Evening before, as the Stages must set off early the next Morning. The Price for each Passenger is *Twenty Shillings*, Proc. and goods as usual. Passengers going Part of the Way to Pay in Proportion.

"As the Proprietor has made such Improvements upon the Machines, one of which is in Imitation of a Coach, he hopes to merit the Favor of the Publick. JOHN MERCEREAU."

Watson, in the "Annals of Philadelphia," tells us that "formerly livery-stables and hacks (things of modern introduction) were not in use.¹

¹ Watson wrote his *Annals* in 1811. We have shown in these pages that hacks (*fiacres*) were introduced into Paris by Nicholas Savage, in 1650, and in a foot-note

Those who kept horses and vehicles were much restricted to those only whose establishments embraced their own stables. The few who kept their own horses without such appendages placed them at the taverns. They who depended upon hire were accustomed to procure them of such persons as had frequent uses for a horse to labor in their business, who to diminish their expense occasionally hired them in the circle of their acquaintance. In this way many who were merchants (the ancestors of those who have now a horse and gig for almost every son) were fain to get their draymen to exempt a horse from his usual drudgery for the benefit of his employers for a country airing. A drayman who kept two or three such horses for portorage usually kept a plain chair to meet such occasions. If the vehicles were homelier than now, they were sure to be drawn by better horses, and looked in all respects more like the suitable equipments of substantial livers than the hired and glaring fripperies of the livery fineries of the present sumptuous days. The ladies took long walks to the miry grounds of the South Street Theater, with the chance of calling for hacks for their conveyance. There is a slight recollection of a solitary hack which used to stand before the Conestoga Inn, in High Street, an unproductive concern, which could only obtain an occasional call from the strangers visiting the inn for a ride out of town. To have rode in town would have been regarded as gross affectation, practically reasoning that, as our limbs were bestowed before hacks were devised, they should be used and worn out first, before the others were encouraged."

The same author goes on: "Mrs. Shoemaker, aged ninety-five, told me that pleasure-carriages were very rare in her youth. She remembered that her grandfather had one, and that he used to say he was almost ashamed to appear abroad in it, although it was only a one-horse chair, lest he should be thought effeminate and proud. She remembered old Richard Wistar had one also. When she was about twenty (1760), Charles Willing, merchant, brought a calash coach with him from England. This and Judge William Allen's were the only ones she had ever seen."¹

Soon after this the English curricule was introduced into New York, where it immediately became popular with a certain class of pleasure-

intimated that there is reason for believing that they were used in London still earlier, in 1634. This would make them over one hundred years in use at this time.

See Watson's *Annals of Philadelphia*.

seekers, ambitious for show on the Third Avenue, the Harlem, and the Bloomingdale Roads, then the principal thoroughfares leading out of the city. These carriages were always driven tandem, with two horses, one in the shafts, another in front, both being decked out with gay trappings. The less wealthy and plainer class of citizens were accustomed to view these "shows" with contempt and scorn. A New York newspaper, published in 1761, announces "for sale, a carriage but little used, with a pair of blood-horses, at Larey's stable," the only allusion we have seen to them in print.

The oldest coach in this country is preserved at the country-seat of the late James W. Beekman, Oyster Bay, Long Island, New York. It formerly belonged to his ancestor, who imported it from London, where it was made in 1762, the year in which the state coach of George III was built. It is so nearly like those represented in Felton's work that we have not thought it advisable to present the reader with a drawing of it.

At the time when these colonies were taking revolutionary measures against the mother-country, there were not more than four or five coaches in all New York. One of these belonged to Sir Henry Moore, the absent governor-in-chief; another to Cadwallader Colden, the lieutenant-governor; Jacob Walton, whose mansion in a changed state still stands on Pearl Street, near Franklin Square, the third; Mrs. Alexander, the fourth; and Robert Murray, the other. This latter gentleman, who belonged to the Society of Friends, and resided on Murray Hill, near the place of this writing, in a measure to avoid the scandal of being thought proud and vainglorious in an age when coaches were treated with scorn, called his merely a "leathern conveniency," to the amusement of "the world's people."

Indeed, such was the prejudice against the aristocracy of those who rode in coaches, and particularly those holding office under the government of "His Britannic Majesty," that when in November, 1765, the odious Stamp Act was about to be enforced, the populace, "in its majesty," proceeded to the foot of Wall Street (Fort Walls, as it was then called), where the mob broke open the stable of Lieut. Colden, and, taking out his English coach, after drawing it through the principal streets of the city in triumph, marched to the Common, where a gallows had been erected, on one end of which Colden's effigy was suspended, with a stamped bill of lading in his hand, a drum at his back,

— in allusion to his having been a drummer in the Scotch Pretender's service in 1760, — and a label on his breast, inscribed, "The Rebel Drummer in the year 1745." At the other end hung an effigy of the devil, with a boot in one hand, — *complimentary* to Lord Bute, — as it was supposed that Colden acted entirely at the suggestion of Satan, and therefore the latter was a fitting companion of his. After hanging there some time, the effigies and gallows entire, being preceded by the coach, were carried in procession to the gate of the fort, where it remained for some time, from whence it was removed to the Bowling Green, under the muzzles of the fort guns, where a bonfire was made of the fence surrounding the green, when the drummer, coach, and devil were consumed, as a sacrifice to Liberty, together with a single-horse chair, two sleighs, and several light vehicles.

The earliest importers of carriages expressly for sale were the brothers Elkanah and William Deane, who came as emigrants from Dublin in 1766, bringing with them several workmen. On arrival here they seem to have changed their minds, and instead of continuing the importation they announced by advertisement that they contemplated opening, "as a new affair," a shop for the construction of all manner of carriages, at five per cent below importation prices, and mention that they *have brought out* workmen at great expense, to build "coaches, chariots, landaus, phaetons, post-chaises, curricles, chairs, sedans, and sleighs," a catalogue ample enough, but too full for the market at the time, and so they offer in addition "to gild and japan, and carve and paint," showing that they did not entertain "great expectations" of a large trade in manufacturing carriages.

The following, copied from an old newspaper dated May 19, 1766, is interesting, as showing that the Deanes could not depend entirely on the workmen they had "brought out, at great expense," from Ireland: "Run away from the subscribers, on Tuesday last, Richard Barlow, by trade a coach harness-maker. He had on when he went away, a Claret colour'd Coat and Breeches, a striped Cotton and silk jacket; he had short Curl'd Hair, is about five Feet seven Inches high, and for some Time before he run away had a condemn'd down Look in his Countenance, which proceeded from his being detected in a dishonest Action. As he is much in debt to the subscribers, all Masters of vessels are forbid to carry him off at their Peril. Who ever secures the said Richard Barlow, so that the subscribers may have him again, or lodge him in

any of His Majesty's Gaols, shall have Five Dollars reward. Given under our hands at New York, this 17th of May 1766, Elkanah and William Deane."¹

The only rival to the Deanes at first was Samuel Lawrence, "wheelwright," followed in 1769 by Elias Anderson and John De Witt; in 1770, by Joseph Chartres; in 1771, by David Shaddle; and in 1773, by David Sawyer, whose principal business was to make and repair the cartmen's trucks, but when occasion required were ready "to fix" the pleasure carriages of the citizens "in the best manner" they were able to do it.

The stage-coach from New York to Boston left the "Fresh-Water on the 24th of June, 1772." The "stage" was advertised "to leave each terminus, once in a fort-night, fare four-pence per mile, New York currency." It took two days to reach Hartford, Connecticut, and two more to get to Boston. The enterprising proprietors promised a weekly stage, should the patronage warrant such an undertaking.

This year (1772) the four-wheeled carriages had increased to the number of eighty-eight in Philadelphia.² William Allen, the chief justice, the Widow Lawrence and the Widow Martin, were the only owners of coaches. William Peters and Thomas Willing were the only owners of landaus. There were eighteen chariots in the lists, of which the proprietor, William Penn, and the lieutenant-governor, John Penn, had each, one. Fifteen chaises completed the catalogue. The William Allen before mentioned, who resided in Water Street, had a coachman, who was a great "whip," imported expressly for his services from England, to drive his coach, with four black horses. To show his skill as a driver, he gave the judge a whirl around the shambles, which then stood where the Jersey Market is since built, and turned with such dashing science as to put the judge and spectators in great concern about the result.³

¹ From *The New York Gazette and Weekly Post Boy*.

² In the MS journal of P. Du Simitière, preserved in the Philadelphia city library, the number is given as eighty-four. This gentleman, a native of Switzerland came to this country and settled in Philadelphia more than one hundred years ago. He appears to have had somewhat of a literary taste, which led him to collect in five volumes a variety of items relating to early history. Lossing (*American Historical Record*, Vol. I, p. 513, note) says Du Simitière's volumes contain a vast amount of chaff, and yet a large quantity of valuable grain may be found in them.

³ See Watson's *Annals of Philadelphia*.

One of the earliest "coach and harness makers" in Philadelphia was John Bringham, ¹ who in 1773-4 is reported to have built the first chair or chaise. His shop was located on Arch, between Fourth and Fifth Streets, where he also advertised to make "all kinds of coaches, chariots, post-chaises, phaetons, waggons, currioles, chaises, kittereens, and whiskies, all of the newest fashions." This was some twenty years later than James Hallet, in New York, had done the same thing in a smaller way. William H. Ent, William Fry, and — Cox, with the Ashmeads, were the other early manufacturers in Pennsylvania.

The limited facilities extended to travelers during our Revolutionary struggle will be inferred from the following advertisement that appeared in the "Philadelphia Evening Post," Sept. 4, 1777: "A person wants to go to Boston, and would be glad of a place in a chaise or wagon going there, or, if only half the way on that road, and a genteel price will be given. Any this will suit will be waited on by leaving a line with the printer." At this period, as we learn from Elkin's "Hessians in America," "almost every farmer [on Staten Island and elsewhere] had his cabriolet and his black servant." It is added, "These singular vehicles, small, painted red, and drawn by two little horses, driven by a negro, appeared to the Hessians new and strange enough." Baurmeister's "Narrative of the Capture of New York" (September, 1776) informs us that the ladies "drive and ride out alone, having only a negro riding behind to accompany them."

After the American Colonies had organized a government of their own, "in Congress assembled," resolutions were passed which, among other things, forbade "the importation of coaches, chairs, and carriages of all sorts from England." This was a serious blow to the coach-building interests of the mother-country, and the death of *that* trade in America. Even the commander-in-chief of the rebellious army, after he had been inaugurated President, was forced to content himself with a second-hand coach, once imported and owned by Gov. Richard Penn, of Pennsylvania. This coach has been described as being very large and heavy, "adding much to its stately grandeur" (!) as it ran through the narrow streets of the Quaker City, with its precious bur-

¹ We find the Christian name of this gentleman given as *George* in a late periodical. We give it as *John* on the authority of C. J. Junkurth, the inventor of the "German-town wagon," who was contemporary in the same business, to whom we are indebted for the chief facts in this paragraph.

den drawn by four cream-colored horses, the vehicle itself being of the same shade, set off with gilded moldings and carvings. Its strongest attractions were the relief ornaments on the side panels, painted by Cipriani, an Italian painter of celebrity, visiting this country, representing in medallions playing Cupids or naked children. The panels may be seen, among other relics, in the Patent Office at Washington, certified as genuine by George W. P. Custis, and presented by John Vanden.

Watson tells us he saw the original coach-body "in 1804-5, in a store yard at New Orleans, where it lay an outcast in the weather, the result of a bad speculation in a certain Dr. Young, who had bought it at a public sale, took it out to New Orleans, and could find none to buy it, where all were content with plain volantes." It is naively suggested that "a far better speculation would have been to have taken it to the Marquis of Landsdown, or other admirers of Washington, in England."¹

A foot-note to the later (1850) edition of the "Annals" informs us that "this old coach body became in time a kind of outhouse, in which fowls roosted, and in the great battle of New Orleans (1815) it stood between the combatants and was greatly shot-ridden [riddled]. Its gooseneck crane has been laid aside for me."

When John Henry, the actor, living in Baltimore, being afflicted with the gout, was compelled to keep a carriage to move about in, the only actor in America who did, aware (1786) of the rather hostile feeling of the public towards players, and anticipating the inevitable sneer about an actor's keeping a carriage, he had painted on the doors, in the manner of the coat-of-arms of the European aristocracy, two grutches in heraldic position, with the motto, "This or these." This *crest* he explained as having been put on to prevent any impertinent remarks on an actor keeping his coach, as the witty would have taken care to forget that he could not walk in the earlier days of our Republic.

Andrew McGowan, of Harlem, New York, has an old sledge, dating as far back as 1783. On the back panel are the letters "S. B." in monogram. This is probably the oldest thing of the kind in America. It is so contrived that by simply removing the box, it can be used

¹ Watson's *Annals of Philadelphia*.

either for business or pleasure. When the sides are unshipped from the runners it is fitted for a sledge, and when not needed may be put away compactly for the summer season.

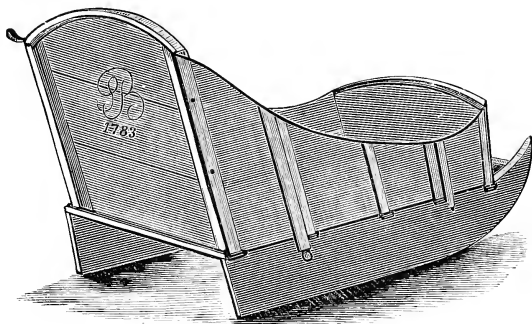

SLEIGH OF 1783.

Of the intervening period between 1776 and 1786, at which last date the earliest New York City Directory was published, — while as yet it contained but few inhabitants, — we know very little. A long and bloody struggle had just ended, with only three succeeding years of peace. The carriages most in request had been *gun*-carriages only, with the making of which the coach-maker is seldom concerned. It appears from the city Directory for 1786 that there were only three coach-makers' shops in New York. These were occupied respectively by Stephen Steel, 81 King Street (since called Pine, and known in 1797 as No. 2) ; Isaac Jones, and James and Charles Warner, in Broadway, before that thoroughfare was numbered. Steel appears to have died in 1798, as we find the following year that the Widow Catharine Steel lived at No. 2 Pine Street. One James Hearne is recorded as having a lively stable at 56 Gold Street, the same year.

Three years later, in 1789, we find that Cornelius Van Auler (no number), in Barclay Street (afterwards No. 30) ; William Collet, 4 Wall Street ; Robert Manly, Dye's Street ; Thomas Parsons, 81 Broadway ; James Kellet, 1 John Street ; and Charles Warner, 6 Great George's Street (since called Broad Street), were added to the above number of coach-makers. Also Thomas Barron, at 38 Broad Street, hung out his sign as "coach-painter and print-seller," while his name-

sake and probably brother — John — kept a shop at 52 Broad Street, where “coach and sign painting” was done to order.

Among “the wheelwrights” of this period we find John Lawrence, corner of Chambers and Little Chapel Streets; Adam Fisher, 4 First Street (now Christie); John Hallet, 121 Queen Street; — Hall, corner of Church and Barclay Streets; John Poalk and Jacob Blanc, in Greenwich Street; George Taylor, Eagle Street; and Christian Pullis, in Chambers Street. James Warner, at No. 6 Great George’s Street, and doubtless brother to Charles, the coach-maker above mentioned; both carried on the harness and saddlery business in the same building. It will be seen, hereafter, that they, for a brief time, were in partnership as coach-makers in the same shop, which is stated to be “near the gaol,” and located in what is now known as Broad Street.

After the time of which we write, it appears that Charles and John Warner, of Great George’s Street, “near the gaol,” kept a livery stable in connection with a carriage manufactory, as did likewise James Hallet at No. 1, and John Ross at No. 5 John Street. Besides these, James Hearne, 56 Gold Street, — Huck, 81 Wall Street, and Patrick Shay, 5 Courtlandt Street, were “Proprietors of Coaches.” The stand for coaches at this time was at the Coffee-House, corner of Wall and Water Streets, the legal rates of fare “to take-up and set-down one passenger within one mile, one-shilling; two passengers, two-shillings; to the two mile stone and ’round by Cummings’ [a tavern then standing in Water Street], for a party &c., six-shillings; Horn’s Tour, eight-shillings; Lake’s Tour, ten-shillings, and for each hour the carriage may be detained on the route, two-shillings; for waiting on company in the city, per hour, three-shillings; to Murray’s half a day, fourteen-shillings; to Gracey’s tavern, sixteen-shillings; to Aphorpy’s tavern, thirty-eight shillings; to Harlaem, one day, thirty-eight-shillings; to the Twelve-Mile Fort, one day, thirty-two-shillings, and to King’s Bridge, fifteen miles, one day, forty-shillings.”

Contemporary with the above-mentioned coach-makers were David Clark and Alexander Penman (both from Scotland), James Simmons, Robert Feeling, Thomas Eagle, William Hunter, and James Kerr, engaged in the same business in Philadelphia. From all we have been able to learn, as before intimated, coach-making in Philadelphia at this time was in advance of the same business carried on in New York. This was owing, in some measure, doubtless, to its comparatively inland

position, and distance from the actual ravages of the Revolutionary War. It must be borne in mind, too, that for some years New York City was in possession of the enemy, which circumstance had a deleterious effect upon all classes of mechanical interests.

As early as 1788, when not more than six carriage-shops could be found in the city of New York, a coach-makers' society was organized, somewhat on the plan of the one in London. This society acted a prominent part in the rather showy pageant got up in honor of the adoption by the States of our Federal Constitution, on July 23 of the year named. A brief account of the coach-makers' proceedings may prove interesting: The coach-makers, in company with the harness-makers, had a stage drawn by ten horses at the head of their division, accompanied by three postilions, dressed in yellow, with jockey caps and trimmings of the same color. Four workmen were on the stage, busily at work. A flag was stretched across the stage, representing a shop with open doors, in which besides was seen (in paint) a finished coach, with other hands at the work-bench. At the door a vessel was represented as laying at the wharf, taking on board carriages for exportation; over the shop the Union flag; over the ship the nine Federal members from this country; in the center, the coach and coach-harness makers' arms: on a blue field three open coaches, supported by Liberty on one side, holding in her left hand the cap of Liberty; on the other side by Peace, holding in her right hand the horn of plenty; Fame blowing her trumpet over their heads; motto, "The Federal Star shall guide our Car." A green monument supported by ten pillars, with a Union in the center; crest on the top of the arms, and an eagle soaring from a globe. In addition to the above, the saddlers, harness and whip makers carried in a separate department an emblematic figure of their profession, — a horse decked out with an elegant saddle and harness, with embroidered tassel, led by a groom dressed in character, attended by two black boys, with a long retinue of bosses and journeymen bringing up the rear. Probably the display on this occasion has never since been equaled by the craft.

The same year Ezra Rice, of Meriden, Mass., is said to have imported (?) a wagon for his own use, which was of very rude construction, being simply a square box placed on four wheels without springs, and drawn by four horses, with ropes for traces and cords for guiding-lines. Yet notwithstanding these drawbacks, the establish-

ment was at this early day in our history considered a very splendid turnout! Previous to this only three chaises, on two wheels, had ever been owned in the town, and these were of rude construction and very unsightly appearance.

Probably the only old coach of American manufacture in existence to-day is the one still preserved in a good state, in the city of Philadelphia, falsely represented as having belonged to our Gen. George

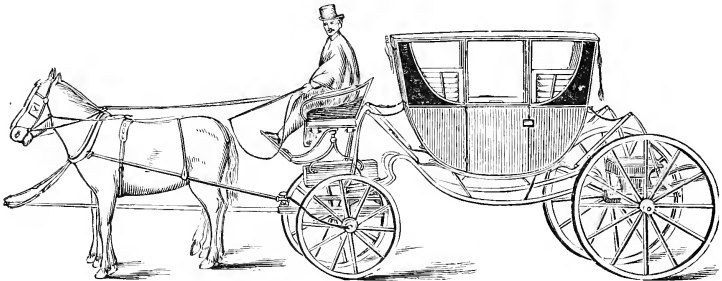

THE POWELL COACH.

Washington at one time, and palmed off as such on more than one public occasion since in the city of New York, backed by the entire press! We have the strongest reasons for believing that Washington never owned this coach, and never even rode in it; and yet the managers of some Sanitary Fairs have charged their dupes a fee for the privilege of sitting a few moments on the cushions where the illustrious Washington once did — not.

We have already shown what became of Washington's imported coach. It now remains to give the history of the one here engraved from a photograph, taken expressly for this volume.¹ Our authority is Mr. Charles Perrie, an aged carriage-maker of the city of Philadelphia. He tells us, and is indorsed by others, that "this coach was built in 1790, by David Clark," who, as we have seen, was a Scotchman, and had a shop on Sixth, between Chestnut and Market Streets, Philadelphia, "to the order of Samuel Powell, of that city. After his death it became the property of his widow, who retained it until she

¹ This photograph was taken for us in February, 1872. The horses, from some defect in taking, look very much like mules.

died, when it fell into the hands of Col. John Hare Powell, a nephew of Mrs. Samuel Powell." It cost, as near as our informant recollected, about \$800,—by the way, a very extravagant price in those days for a carriage. But as this was of home manufacture, and a very fine establishment withal, it was not considered too much. For a long time this carriage, "as a willful mistake," was exhibited as Washington's in Wood's Museum. At a later period it "ornamented" the repository of William Dunlap, who likewise gave us the history of this coach.¹ It has since been disposed of to a Mr. Wharton.

Congress, looking upon carriages as an article of luxury, imposed a tax upon them in 1794. They numbered in Philadelphia, at the time, thirty-three coaches, one hundred and fifty-seven coaches, thirty-five chariots, twenty-two phaetons, eighty light wagons, and five hundred and twenty chairs and sulkies, showing that in about twenty years they had greatly increased.²

A team of horses to a carriage in those days might average thirty or forty miles a day, taking about two weeks to go from New York to Pittsburgh, three to Columbus, four to Cincinnati, or six to Chicago or

¹ It is really melancholy to see how much *fiction* there is palmed off upon the world as sober history, of which the above is only one example. In the *Historical Magazine* we are told that "the first carriage built in America is said to have been made by a man named White, in Dorchester, Massachusetts, for a private gentleman in Boston, in 1805," which was fifteen years after Powell's coach was made. "This (White's) was copied from a kind of English chariot, made much lighter and said to have been creditable to the builder. It was, however, found to be much cheaper to order them from Europe, on account of the high price in material and excessive cost of wages. A plain kind of wagon, with the simplest description of finish and trimmings, was made in the cities of New York, Boston, and Philadelphia." The most charitable construction to be found for the writer's statement is in the supposition that he confounds the *fact* that the first carriage was built in Massachusetts in 1805, with his *belief* that it was the first built in America. Our investigations may set him right on this subject.

² Another account says that the record of duties on pleasure-carriages made the full return five hundred and twenty chairs, thirty-three sulkies, eighty light wagons, one hundred and thirty-seven coaches, twenty-two phaetons, thirty-five chariots, and thirty-three coaches; total, three hundred and seven four-wheeled carriages. In 1801, when the tax ceased, there were, exclusive of the county, three hundred and six four-wheeled chaises. At present (1811) there can be no doubt of their being much improved. The increase of hacks also would greatly swell the number. — MEARS'S *Picture of Philadelphia*.

According to Cox's *View of the United States*, Winchester, Virginia, contained one or two coach-makers, five or six blacksmiths, and three or four wheelwrights at this time.

Springfield, Illinois. The stage-coach which, with relays of horses, made one hundred miles a day, did wonders; and the famous old Pennsylvania wagons, drawn by six or eight huge horses, with a ton or thereabouts to each horse, were doing marvelously well to jog, snail-like, over from eight to fifteen miles a day on the average. These teams usually occupied a month or six weeks in conveying a load of merchandise from Philadelphia to Pittsburgh or Wheeling. It is recorded that two emigrants from Canaan Four-Corners, a place a little east of Albany, New York, to Cleveland, Ohio, at this period (1798), took ninety-two days to perform the journey. The road from Fort Schuyler (Utica, New York) to the Genesee, which in 1797 was little better than an Indian path, is stated by Capt. Williamson as being in 1799 so far improved that a stage started from Fort Schuyler in September, to arrive at Geneva on the third day, with four passengers. In the winter of 1797 two stages ran from Geneva to Canandaigua, weekly, but it was eighteen years before a stage, carrying the mails between Canandaigua and Rochester, a distance of twenty-eight miles, ran as often as twice a week. "Only nineteen years preceding our journey," says one who traveled over the route in 1828, "a friend of ours, who had gone in the first gig that had reached Niagara, and although it was drawn by two horses tandem, he was a whole day in going over a route of sixteen miles much filled with 'corduroy logs.'" In June, 1800, one Uriah Tracy, of Litchfield, Connecticut, was summoned to Washington, and received an appointment as commissioner, to examine into the actual state of the Indian trading-houses at the Northwest. His accounts have been preserved, and the following items show the time and cost of the journey between New York and Washington then: June 20. — Stage fare from New York to Philadelphia, \$5; expenses on the road to Philadelphia, \$3.75; expenses in Philadelphia, \$7.25. June 22. — Stage fare from Philadelphia to Baltimore, \$8; expenses on the road to Baltimore, — expenses at Baltimore, \$4.12½. June 25. — Stage fare from Baltimore to Washington, \$3.50; expenses on the road to Washington, \$2.25; or \$33.87½ for expenses on a journey which now costs \$8.50, and instead of five is easily performed in a day.

The reader will understand from the foregoing facts, gathered from authentic sources, that to make a journey of fifty miles was a matter of no little difficulty. Those who were able to keep their own private conveyance were exceedingly glad if they could come across "a cheer,"

as they were then called, which they might purchase. These vehicles "of the period," which we have endeavored to exhibit, were the only ones seen in the rural districts, the costs of which in those days was no inconsiderable sum. They were all hung upon springs made of wood generally, with rude bow or standing-tops of round iron, hung around with painted cloth curtains. The linings and cushions, stuffed with "swinging tow," sometimes

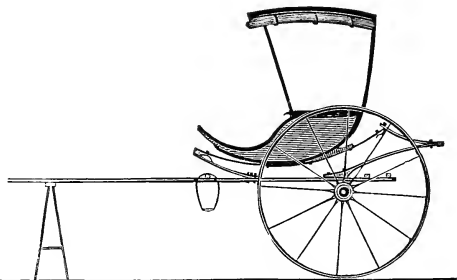

THE CHAIR OF 1790.

salt hay, were in those primitive times of simplicity and innocence deemed good enough for any American sovereign, and very fortunate was he who could get even a short ride in one! The poet Holmes has immortalized the "one-horse shay" in a lengthy poem, from which we have taken the motto for this chapter.

In 1789 it is stated there were only 7,904 inhabitants in New York City. About this time Daniel Ross went from New York and commenced the coach-making business in Newark, New Jersey, where he built a carriage for the Kearney family. Previous to this, nothing but the old-fashioned chairs, hung upon wooden springs, had ever been made there. Ross's carriage, although made in the plainest manner, is said to have been "substantial in all its parts." Soon after this experiment, an English coach was brought to Newark by the Kemble family, having been purchased in Philadelphia. This coach excited a great deal of curiosity, and it is stated that Robert B. Canfield, an old carriage-maker, recently deceased, but who at the time had just commenced business, and only made work of the simplest pretensions, took patterns of its several parts, examined it well, and determined to imitate it as well as he could. Being without the tools necessary to make some parts of the carriage, Mr. Canfield started on foot for New York in the morning, returning to Newark in the evening with the tools wanted. He immediately set himself to work, and soon produced a coach as nearly like the English prototype as possible. Mr. Canfield afterwards

took it to New York, and offered it for sale as his own manufacture. This story the "Yorkers" would not credit, as they thought a carriage of such skillful workmanship could not have been made in a country shop. He succeeded, however, in selling it finally, and the proceeds supplied him with his first capital for the extensive business he afterwards carried on. This year we find that the afterwards distinguished coach-maker, Abram Quick, was merely a journeyman painter, residing in Cross Street. Three years after he lived at No. 6 Fair Street. It is not until 1816 that he figures as a coach-maker in the city Directory, from which he retired in 1826. We shall have occasion to speak of him again.

In 1798 Joseph Powell, 73 Broad Street; Thomas Parsells, 145 Broadway; Cornelius Van Allen (Van Auler?), 30 Barclay Street, were the names of the coach-makers then in business. Charles Warner, at No. 7, and James, his brother, at No. 9 Barclay Street (both removed from No. 6 Great George's Street), having dissolved, each set up a harness-making shop on his own account. A. Peel was coach and *chair maker* at No. 26 Broad Street. Up to this time very little had been done in the manufacturing of carriages. Those chiefly made were wooden spring chairs or chaises, a rude kind of wagon, and jobbing. The finer kinds of carriages, such as they were, were still nearly all imported from Europe.

About 1810 the shops in which, in some shape, carriage-making was done, amounted to twenty-eight. The proprietors were William Ross, 208 Broadway, corner of Fulton Street; Burtis & Woodward, 280 Broadway, corner of Chambers Street; John Higin, 368 Broadway; Alexander C. Wiley, 392 and 482 Broadway; Fred. Bomiler, Broadway, near Spring Street; John Bloodgood, Nos. 5, 7, and 9 John Street; James and John Warner, still each at the old places in Barclay Street; Berrian & Cullum, 23 Chamber Street; Henry Stibbs, 34 Vesey Street; Nathaniel Jeroleman, 90 Reed Street; Abram Quick, "coach painter," 62 New Street; Daniel Fraser, 39 Frankfort Street; Jacob Crissy, 32 Robinson Street; George Griffing, 40 Chapel Street; Griffith Griffith, 437 Pearl Street; James Brower, 11 Partition Street; Cornelius Van Allen (whose name is variously printed), 56 Leonard Street; Thomas Thorne and Robert Hardy, both at 57 Walker Street; Jacob Peterson, "coach-maker and wheelwright," 20 Mott Street; John Woodward, 40 White Street; Ozeas Smith, 12 Batavia Lane;

James Simpson, in Bancker, now Madison Street; Thomas Lincoln, 13 Magazine Street; Samuel Hallet and Henry Hamilton, in the Bowery, near North, since called Houston Street. These are all called coach-makers, but scarcely deserved the name. Such have been the changes since, that not one of the places named is now occupied for the coach-making business. Virginia and a portion of Massachusetts this year reported as built 2,413 vehicles of all kinds, the revenue in seven States amounting to \$1,449,849.

Thomas Jefferson, the third President of the United States, at the close of his term of office, had a carriage built after a design of his own, the entire work of which, except the plating, was done by his own workmen. In this carriage, we are told, he drove four horses, with a great show of splendor, which, considering his character, attracted much notice. To the horses he gave the names of Washington, Wellington, Eagle, etc., ordering that they be driven in an unusual manner, without reins, two servants on horseback guiding each a pair.

Carriage-making was established in Albany early in the present century, in a small way. When our informant, James Goold, Esq., now over seventy years of age, settled there in 1813, he found in business Joseph Thinkell, Robinson & Vanderbilt, and John Epps. Epps employed about a dozen hands, and Robinson & Vanderbilt twelve or fifteen. At the time when Mr. Goold began business (which he did with only a boy assistant), the work chiefly done was building long-bodied wagons hung on elliptic springs *made of wood*, and occasionally a hack for carrying passengers between that place and the neighboring towns, then bordered by wilderness.¹

In those days the chief mode of private conveyance among the rustics was by the chaise already described, or a rude sort of wagon, of which we give an engraving on next page. As will be observed, the body was set on bolsters, the springs being under a sort of chair-seat, made of wood, in the shape of an elongated S, attached to a frame in the bottom of the wagon. This could be put in or taken out when

¹ The first manufacturer of coach-springs in New York was one Williams, from England, who worked in the same shop with the celebrated Grant Thorburn. He is said to have prospered and made money until he became an infidel and attached himself to Tom Paine's party, after which he became a pauper, and died in the almshouse, an outcast. Previous to this, and for some years afterwards, they were imported into this country from England, chiefly of Slater's make, whose trade-mark was three crowns.

desirable, and then the wagon was useful for business purposes, in an age when business was more important than pleasure-taking.¹ To

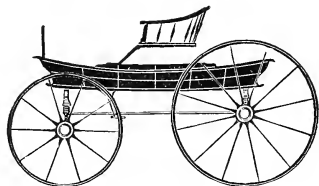

COUNTRY PLEASURE-WAGON.

make one of these seats, to do which an apprentice was allowed but a single day, was quite a difficult task to perform, since, as in chair-making, much of it was done "by the eye," and all by hand.

The same year in which Mr. Gould settled in Albany, Lewis Downing, then a young man of twenty-one years, went from Lexington, Mass., and opened a wheelwright shop in Concord, N. H., with a capital of only a hundred and twenty-five dollars, seventy-five of which was invested in tools. The work made was the common wagon, then called "buggies," the body of which was bolted to the hind axle, as we have previously seen, and then sold for sixty dollars, a good price for that day. The first year he worked alone, and as he did not have any blacksmith, he usually took the wood-work of two wagons at a time to the New Hampshire state-prison to be ironed, he doing the painting himself. The first wagon finished was sold to Dr. Samuel Morrill, of Concord.

Sleighs were very early constructed in America, the severe winters formerly encountered encouraging their use. A correct representation of those in fashion sixty years ago may be seen in the next figure, considered by our grandmothers good enough for them to ride in while looking out for a husband! Many interesting episodes have been promulgated in connection with these old sleighs, and no small amount of courting has been accomplished through their agency, especially in the New England States, where it was the custom, when the sleighing became favorable, to make up a party, chiefly young people of both sexes, for a drive to some distant village, where a good supper was

¹ About this time steam power was first used in ferrying passengers, etc., from New York City to Brooklyn in place of horse-strength. The *Columbian* of May 14, 1814, thus notices "the *Nassau*, the new steamboat belonging to Messrs. Croting & Co., which commenced running from Beekman Slip to the lower ferry at Brooklyn a few days ago, [and] carried in one of her first trips 549 (another counted 550) passengers, one wagon and a pair of horses, two horses and chairs, and one single horse. She has made a trip in *four minutes*, and generally takes from four to eight, and has crossed the river forty times in one day."

ordered, and discussed with a sharpened appetite. Later in the evening the parties drove home, to dream through the night about the incidents of the sleigh-ride, often with a dart from Cupid's bow transfixed in the heart.

The next engraving is from the photograph of a sleigh built by James Goold, Esq., of Albany, in 1816, which is still used by its present owner, C. C. Bradley, of Syracuse, N. Y. After the service of half a century it still gives much

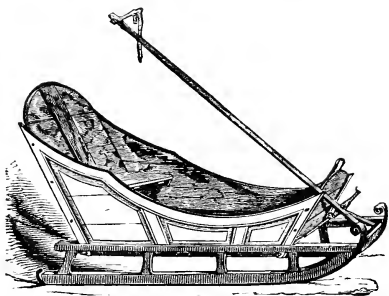

EARLY AMERICAN SLEIGH.¹

promise of indefinite wear. For over fifty years, Albany sleighs, made under the supervision of Mr. Goold, have borne an enviable reputation both at home and abroad, always commanding the highest price in the market.

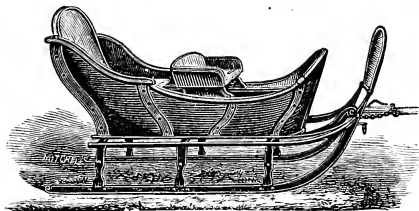

ALBANY SLEIGH.

At this period (1816) C. J. Junkurth, at Germantown, Pennsylvania, built a carriage for James Duval, of the same place, which, on account of its novelty, was called the *Germantown*, in compliment to the place, then a small settlement located seven miles north-west of the city of Philadelphia; but more of this hereafter.

The first line of mail stages between Boston and New York was run by Lewis Pease in 1784. This same gentleman is said to have projected the first turnpike road in New England. Before this the mails went only once in a fortnight between the two cities, in a pair of saddle-bags, on the back of a horse. It was not until 1817 that stages

¹ The following is extracted from a letter to the author from Joel Mansell, Esq., of Albany, Jan. 27, 1870: "I remember this sleigh in my boyhood in the Connecticut Valley fifty years ago. Possibly it might have been fifty years old then, or even more, for in those days the world moved slow and the fashions moved slower. Mr. Wemple remembers them sixty years, and knows nothing beyond."

came into general use, under the presidency of Munroe. Originally a European institution, many improvements were added to them in this country. The attachment of rack and boot, made to swing with the body, originated in Salem, Massachusetts. An experiment of using the English post-coach body on platform springs, in opposition to the American improvement, was tried in Baltimore at about the same time, unsuccessfully. Mr. Butterfield, whose name has since been known in connection with some of the most successful enterprises of the day, used to run post-coaches in connection with the Hudson River steam-boats from Albany to Ballstown and Saratoga, which were usually crowded with passengers, previous to the building of the New York Central Railroad, which ruined the business.

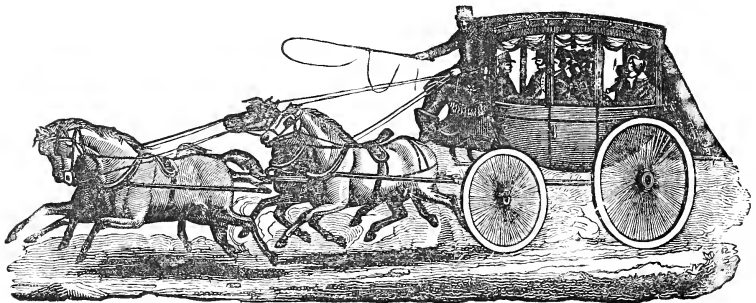

AMERICAN STAGE-COACH, 1830.

At one time the manufacture of these vehicles was extensively carried on in Albany, but was subsequently monopolized by the Trojans, at the head of whom stood conspicuously Orsamus Eaton. Mr. Chapman, at Northampton, and Jason Clapp, at Pittsfield, both in Massachusetts, were early accounted enterprising builders of these coaches, the costs of which varied from \$450 to \$500.

Mr. Thurlow Weed informs us that the stage-drivers of former days "lived merry but short lives. The exceptions were in favor of those who, after a few years' experience, married some reputable farmer's daughter on their route, and changed their occupation from stage-driving to farming. . . . It is but a few weeks since I saw in the papers an announcement of the death somewhere in Tompkins County of Phineas Mapes, aged eighty years. Phin. Mapes, a rollicking

stage-driver at Catskill, is one of my very earliest remembrances. In 1803 or 1804, a stage with four or five horses was an institution, at least in the admiring eyes of the boys. I remember with what a flourish Mapes used to dash up to the post-office door, and while Dr. Crosswell was assorting the mails, how gracefully and gently he would throw his long whip-lash over the backs of the leaders, and how, by the responsive action of the forefeet, nostrils, and ears, they would show how well they understood that he meant it playfully. How well, too, I remember when in 1810 or 1811 I renewed my acquaintance with this driver at Skaneateles, between which place and Onondaga Hollow he was blowing his horn and cracking his jokes, quite as popular here as he had been at Catskill. The oldest inhabitants of Catskill and Skaneateles, as well as the few survivors who rode in stages upon the great Genesee turnpike, sixty years ago, will remember Phin. Mapes pleasantly, from whom, in his best days, Dickens might have found 'a jolly original for Mark Tapley.'

As before intimated, the introduction of railroads is fast driving the post-coaches, once such favorites with the public, out of the country. Recently a mournful company of old stage-drivers, proprietors, and agents, who thirty years ago, on the banks of the Connecticut, first commenced to lay aside the whip and horn, to make room for the bell and whistle, had an old-fashioned stage supper in Springfield, to recount over their former adventures, and weep over the loss of their occupation. These, as a class, were highly social individuals, now driven off the road to earn a precarious living by marrying "vidders," and tending pikes and switches."

The coach-makers still in business in New York, in 1820, mentioned in our previous catalogue, were Cornelius P. Berrian, 23 Chamber Street; James Brower, Suffolk, near Rivington Street; George Griffing, 40 Chapel Street; Nathaniel Jeroleman, 50 Leonard, near Chapel Street; Abram Quick, 52 and 54 Broad Street, and William Ross, who had removed from 208 to 405 Broadway. A nest of Rosses had now got into the business, namely, William and John E. Ross, 138 and 140 Fulton Street, previously known as Fair Street; William S. Ross, 146 Fulton Street, and James Ross, 409 Broadway. Cornelius *Vanaulen* had not only changed the orthography of the name, but represented the family in business at 54 and 88 Leonard Street. The following opposition shops had sprung up since 1810: Nicholas Lawrence, 412

Broadway; R. P. Lawrence, 5, 7, and 9 John Street (afterwards Bloodgood & Lawrence); Daniel Stevens, 407 Broadway; Oliver & Parker, 348 Broadway; Milne Parker, coach-maker and repository, Broadway, near Spring Street. This would appear to be the first repository established in New York. Mr. Parker left the city in 1827, and went to Yorkville, then a village adjacent, and a few miles out of town, where he continued in business one year; Robert G. Hardie, 14 New Street; William Chapman, Church, corner of Leonard; Gilbert Bowne, 26 Thomas Street; Peter McNeil, 164 Chamber Street; William Mitchell, Collect, corner Anthony; John Riker, Lispenard, near Church; William C. Smith, Hester, near Broadway; John Woodward, Jr., 127 Orange Street; John Foster, 33 Jay Street; James Brady, 253 Greenwich Street; Thomas Charters, 26 Charlton, near Hudson; A. Brown, Laurens, near Prince; William H. Pinckney, 154, and William Slack, 214 Bowery; James Cleland, Thompson, near Spring; and James Coe, one of that name at 17 Mulberry, and another at 15 Bancker (Madison) Street. Subsequent to this (in 1827) Cornelius P. Berrian had taken possession of No. 7 John Street, previously occupied by Bloodgood & Lawrence. In 1816 A. Quick had removed to Broad Street from 16 Marketfield Street. In 1827 James Brewster, of New Haven, bought out Quick's establishment, and took into partnership Mr. John R. Lawrence.

The following story, which appears to have created much interest among the craft some time between the years 1820 and 1825 (some say in 1822), we have often heard related by the older members. Milne Parker, whose self-esteem was largely developed in his conduct, challenged the world, through the public press, to compete with him in building a gig, as chaises under a modified form were then designated. Abram Quick, nothing daunted, *quickly* accepted the challenge, stipulating that the best maker should have the two, — Parker's original offer, — and in addition thereto the loser should forfeit \$500, and give a suit of clothes to each of the referees. Both vehicles were to be made without paint, putty, or trimming. Parker employed Othneal Smith to make his gig body, and Philip Vermilyea to do the iron-work. Quick's was made by James Brady, and ironed by — Davis. When both were ready, the jury of carriage-makers — Robert Hardy, Cor. P. Berrian, and Richard P. Lawrence — decided, after due inspection, that the gig made in Quick's shop was the best. This

Parker was loath to believe, and showed considerable reluctance in parting with his gig. In this emergency our informant, Mr. John R. Lawrence, was sent for the vehicle, and after much parley he succeeded in getting a promise from Parker that he would deliver it to the winner when it should be completed in the wood and iron work, which promise was fulfilled a few days afterwards.

Milne Parker, the loser of the gig, seems to have turned his chief attention to the manufacture of *volantes* for the Cuban and Mexican markets, this kind of carriage being a great favorite with the Spanish ladies from that day to this. Philip Vermilyea, who appears to have been Parker's blacksmith in general, and a *great blower*, on a certain occasion headed a public procession through the streets of the city, with the express object in view of showing off Parker's volantes and

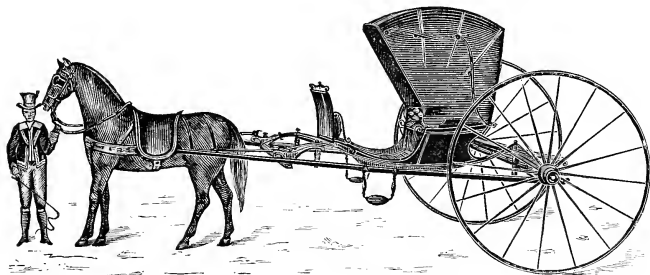

SPANISH VOLANTE.

"astonishing the natives." At every convenient point on the march "Phil." would stop the party in the interest of Parker, and say to the gaping crowd, "Gentlemen, those fine specimens of work were made at Mr. Parker's shop in Broadway, *not* in Fulton Street by the Rosses," between whom and Parker a rivalry in business appears to have existed. Phil. probably "kept mum" concerning the gig he ironed off, and which Parker found so bad *that he was obliged to give it away!* At the present time Cuba is supplied with volantes from France and England.

Our illustration represents a volante built for Jenny Lind when she visited Havana in 1850. The dimensions from actual measurement are: width on the seat, 3 ft. 2 in.; the wheels, placed in the rear, 6 ft. 2 in. high; hub, 8½ in. in diameter; tracking, 4 ft. 11 in.

Dressed in the gaudiest of apparel, although bonnetless, the dark-eyed creoles of Cuba make the tour of the promenades in these volantes with the greatest ease. Notwithstanding the clumsy make-up, devoid of springs, we are told by those who have tried them that these volantes make nothing of deep ruts and other obstacles as they dash along the road, imparting the most pleasant sensation to its occupants, often three in number. Some of these vehicles are very costly, as high as \$1,500.

The postilion (*calisero*), in our picture dismounted, always rides when the horse is on the move, dressed in a scarlet jacket, with high jack-boots set off with silver buckles at the knee, spurs to his heels, and a showy cockade in his hat. His services relieve the passengers of all care and greatly promote their comfort.

About the period of which we are writing, A. Quick, Bloodgood & Lawrence, William and John E. Ross,¹ C. P. Berrian, and John Riker, who were the chief manufacturers, and consequently the greatest sufferers from the introduction of "country work," undertook to get a law passed by the Common Council preventing the rural carriage-makers from offering their wares for sale in the streets, which they were accustomed to do in front of Trinity Church, on Broadway, and the Tontine Coffee House, corner of Wall and Water Streets. For this purpose a meeting of the city carriage-makers was called together. Among other things, Abram Quick, who was an off-hand and free-spoken man, said, "Gentlemen, we are in a similar position with our Saviour on the cross: we are between two thieves, — Connecticut on the one hand, and New Jersey on the other." This opposition on the part of the trade in New York originated the establishment of carriage repositories for the sale of ready-made work.

A man by the name of George Burnie is said to have been the first to open a repository in New York for the sale of country-made work, at 61 Walker Street, in 1823. At first he sold on commission, but

¹ The first landau built in New York is said to have been done in the shop of William and John E. Ross, at 138 and 140 Fulton Street, by James Ross. Mr. Slack, who was a journeyman in another shop, and noted for a nice taste when applied to carriages, on one occasion was passing by the shop when this landau stood in front on the sidewalk. Ross, who saw him passing, hailed him with, "What do you think of this, Slack?" Slack, passing his hand over the panel in a careless manner, sneeringly replied, "Oh, pretty well, *considering who made it*," and went on his way, leaving Ross to draw his own inferences.

finding it more profitable he afterwards bought the work and sold it on his own account. From report we incline to think him to have been a shrewd business man. His imitators in the same line were Paul Perrin, at 34 Canal Street, who afterwards *vamoosed* with other people's funds; Isaac Mix, also in Canal Street; John Cook, successor to Burnie; John Thompson, 27 Wooster Street; McChesney & Lawrence, in Broadway, above Canal Street, and since by others. A society was likewise organized among the journeymen, with advantage to no one, except that it drove trade into the country, where from 1825 to 1830 the manufacture of carriages was chiefly done, and afterwards shipped to New York. Especially was this the case in Connecticut, and every little village had its carriage-maker's shop, many of them with one or more New York journeymen. Although much of the work sold in New York is still made elsewhere, yet in consequence of the *recklessness* of some manufacturers in getting up "cheap work" to undersell the "city-made," the tide has since set in favor of the latter, and the best carriages are now produced by a few leading houses in the metropolis. The fact is, that where rents are high, to get up cheap work will not pay. This truth has so long been "dinned" into the ears of customers by interested parties, that the public, who have the "tin," have come to accept it as a fixed fact, and so are readily induced to give a higher price for city-made carriages than for any other. The price demanded requires that the work be done in the best manner possible in order to sustain a reputable position with the public, and to do this the mechanic is encouraged by the price he gets for it.

We now propose to give illustrations of some of the carriages of "the period," taken from a manuscript volume prepared by the author of this work over forty years ago, transferred from the black-board. The first was called a buggy, the body of which, if not very handsome, was yet very strong and substantial. The side elevation was composed of rocker and pillar, behind which was placed a board three quarters of an inch thick to serve as the side panel, on which was glued and fastened by screws from the inside a broad, half-round molding *for ornamental purposes*. From this example the reader will readily see that weight was no objection

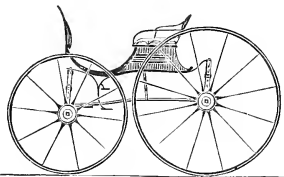

AMERICAN BUGGY, 1826.

to a carriage in those days. This vehicle was designed by no less a workman than John Graham, who had acted as foreman in the shop of Messrs. McChesney & Lawrence, the Broadway coach-makers, previously mentioned in these pages.

The next was known as the *fantail gig*, besides which there was another called the *tub-bodied gig*, this last being similar in sweep to the gig curriole on page 347. These were strictly what is denominated by the craft paneled jobs, to build the bodies of which in those

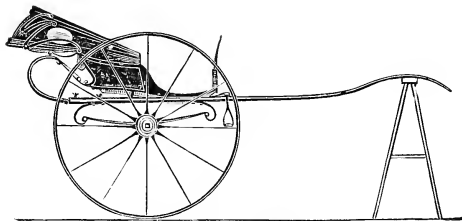

FANTAILED GIG.

times, when everything was got out by hand from the plank, required from five to six days. A circumstance in relation to building these bodies will astonish, if not amuse, the modern workman. In the cat-

alogue of builders of post-coaches mentioned on another page we have alluded to one Chapman, of Northampton, Massachusetts. This man, when a journeyman, labored in the same shop with our boss, one Daniel Platt. Many times we have heard him relate, as an incentive to greater exertion among the hands, the exploits of Chapman in building gig bodies. Said he, "Chapman was the fastest man I ever saw for making gig bodies. He was accustomed to make a body in two days, and the only tools used were an ax, drawing-knife, and plane!" Some of the workmen, not over-credulous nor much refined, used to say that it was well for the craft that he early "shuffled off this mortal coil," for had he lived he would have monopolized all the trade, and left very little for others to do.¹

A very fashionable wagon of the period (1827) is shown in the next engraving, copied from our hand-book. In the eyes of the modern mechanic it appears to much disadvantage, but at the time they were considered handsome, especially when graced with a bow-top or head.

¹ A Boston chaise at this date sold for \$150 to \$200, and sometimes, when richly plated, as high as \$250. The actual costs were about as follows: cost of body, \$23; ditto wheels, \$15; carriage part, \$7; iron-work, \$22; painting, 15; trimming, \$17; silver-plating, \$18; total costs, \$175.

The body is of the description known as a "slat-sided job," but of simple construction, consisting of bottom sides, bob-pillars, slats, and raves, the panel having but little swell.

Another carriage of the period is depicted in the center engraving on this page, and known as a *chariotee*, although the claim to such honor is questionable. The hinder portion took the form of a tub-bodied gig, which, having an extended toe-board, supplied room for a second seat by the addition of standards made out of hard wood. For a summer carriage it answered a very good purpose, but exposed the passenger too much in winter weather, even when supplied with an extension top.

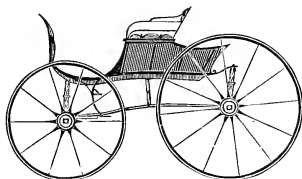

SLAT-SIDE PHAETON.

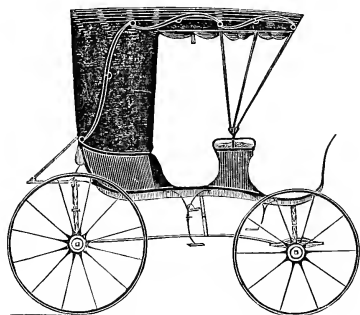

GIG CHARIOTEE.

A far better design for a chariotee is found in the figure below, constructed with doors in the sides. This is known among the craft as a paneled job, and in its day was considered a very aristocratic vehicle, to build which taxed the

ingenuity of many of our best workmen. The so-called "French rule" was then unknown among us, and those who undertook to build were compelled to work chiefly by the eye, which is not always a safe guide, especially where the non-mechanical eyes outnumber the mechanical. But art was then in its infancy, and our granddames thought themselves fortunate when they got a ride to meeting in one of these vehicles.

Prior to this period (1827) there had been no vehicles constructed for the special purpose of taking up and setting down passengers in

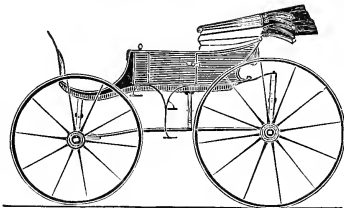

AMERICAN CHARIOTEE.

the streets of New York, although the suburbs at Greenwich Village, Yorkville, and Harlem were connected with Wall Street by regular trips through the day.

John Stephenson, Esq., to whom we are indebted for the annexed drawing, and many facts given in connection with this portion of our history, informs us that the first vehicle constructed for street passengers was the *accommodation*, seating twelve persons inside, the passengers

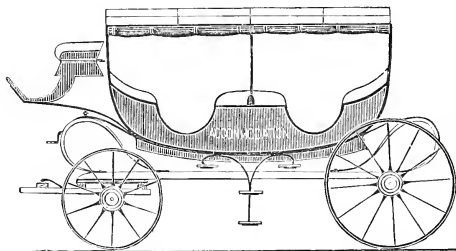

THE ACCOMMODATION.

entering at the sides. The body of this carriage hung on leather thorough-braces, something after the manner of the post-coaches of the times, of which it was a modification. This was made by Wade & Leverich for Abraham Brower, who ran it on Broadway, from Bleeker to Wall Street, at the uniform fare of one shilling a head for all distances, Bleeker Street in those times being "away up town."

In 1829 the *sociable* was placed on the same line. This was made by the same firm and run by the same owner as previously named, the design in both being somewhat similar, only the latter was entered from the rear instead of the sides, by means of an iron stair-way furnished with a hand-rail, as shown in the picture. This is said to have been the first vehicle used for pas-

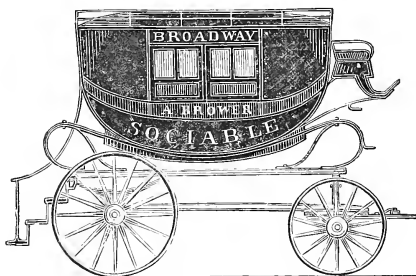

PUBLIC SOCIABLE.

sengers in New York, having seats running lengthwise with the body, the sides of which were provided with movable glass frames and cur-

tains. The body was, like the previous one, hung on thorough-braces, these last resting upon a frame supported by three cradle-springs. This sociable, although clumsily made and hanging high, was easy-riding.¹ The same year Ephraim Dodge ran a hack from the city proper to South Boston. The route lay over the old bridge, up Fourth Street, the attempt to use the main street being frustrated by the sinking of the carriage to the hubs in the soft clay. Soon after a second hack was put on the line, fare ninepence (twelve and a half cents).² An opposition line was started in 1838, when the fare was reduced to six cents.

Our next illustration represents a species of barouche. This in some degree took the place of the coach, then seldom to be seen except in the larger cities.

It carried four passengers inside and two on the dickey-seat, this last being built in the body, as shown in the engraving. A baggage-rack attached to the body by leather straps was an indispensable adjunct to all vehicles of this kind.

The sword-case, an heirloom of feudal times in Europe, was then generally put on in solid wood, "more for ornament than use." Crime has since so much increased that a pistol-case might with advantage occupy its former position.

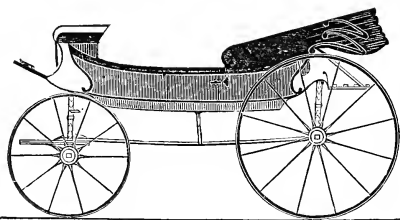

AMERICAN BAROUCHE.

A more pretentious barouche, hung upon C-springs, appears in the

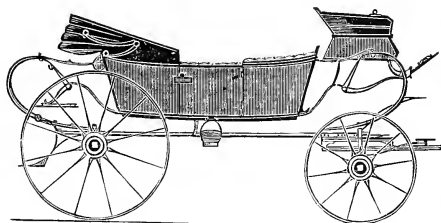

C-SPRING BAROUCHE.

next illustration, which we have selected from a collection of drawings made by Getting, from Paris, for G. & A. K. Carter, once popular carriage-makers in Newark, N. J.³ Although simple in design, there is a look

¹ From a letter to the author by John Stephenson, Esq.

² See Simonds's *History of South Boston*, p. 224.

³ For this and several other designs that follow we are under obligations to the late

of neatness about it absolutely charming. A detached dickey-seat graces the front of the vehicle, being quite an improvement over the preceding, as will be observed on comparison therewith. To ride in such a carriage was sufficient to attract the attention of all eyes in those days.

We have stated in another place that coaches were seldom seen in this country, outside of the larger cities, at the period of which we

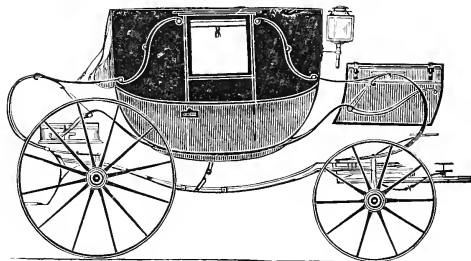

AMERICAN TRAVELING COACH.

write. Of those made, Newark chiefly monopolized the trade. We give an illustration, by Getting, of the traveling coach of 1830. Only a favored few could maintain so expensive an establishment as this, and the roads over

which it was safe for such to travel were comparatively scarce. The "budget" and trunk-seat we have met with before in our English history, consequently we cannot claim originality in this particular.

The next engraving represents a *coachee*, also hung upon C-springs, but costing a trifle less to build than a coach, being finished with side curtains to roll up in place of panels. Aside from the expense, a vehicle thus constructed not only looks much lighter,

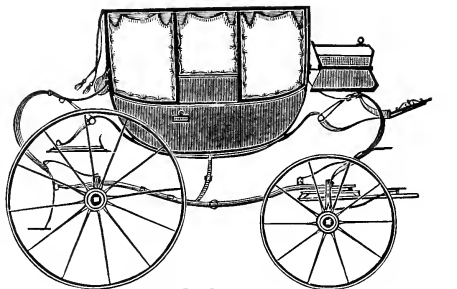

C-SPRING COACHEE.

firm of Quimby & Co., of Newark, N. J., in whose possession, as successors of Carter & Mitchell, the originals now are, and who kindly permitted us to copy them in a reduced form for this work. Getting, who made his drawings chiefly from finished carriages, was quite an expert in this line of business, at which he spent two or three years in this country.

but is really more airish, — two very requisite essentials in a town equipage. A great fault with the greater proportion of our earlier carriages was, they hung too high from the ground, necessitating a long folding-step, which when not in use was hidden away inside of the door, rendering the carriage very dangerous, as well as liable to upsetting.

In the accompanying illustration we have a *dickey-seat phaeton* for the first time in this new country, adding to our then limited variety of vehicles. The Stanhope and Tilbury were both introduced about this time (1830), and this phaeton is mainly an

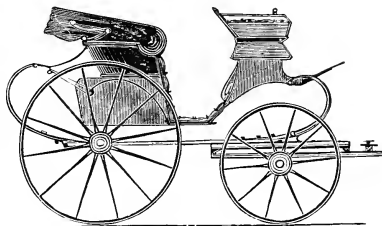

DICKEY-SEAT PHAETON.

adaptation of the former to a new purpose, the construction of a novel carriage, differing from any which the American public had been accustomed to see on the streets.

The *traveling chariot* is another of the designs furnished by our

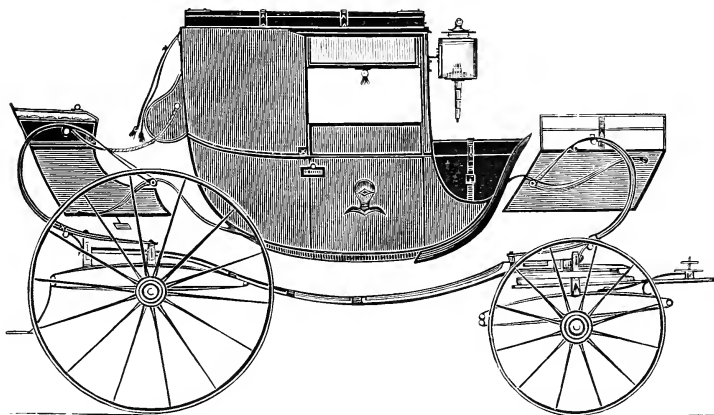

TRAVELING CHARIOT.

Newark friends, the general character of which is unmistakably European. It is a very fair specimen, on a limited scale, of what would

have been done in America in the preparation for traveling, had not the "iron horse" made its advent in the nick of time. Its facilities for the storage of luggage are quite limited when compared with those in Chapter X. Indeed, they scarcely meet the demands of a Saratoga belle in modern times. But then our grandmothers were less exacting, and did not make such heavy drafts on their husbands' pockets!

In 1831 the Stanhope fever, which had reached our shores from England, raged in this country for one or two years, culminating in

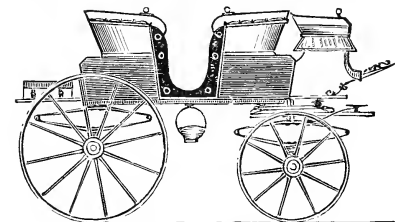

DOUBLE STANHOPE.

the Siamese monstrosity here annexed. To this carriage, by extending the bottom sill, a place for baggage was provided behind, the like extension in front serving as a support for the dickey-seat. This vehicle was a little too clumsy to suit the American taste. With its disappearance came the *Carter buggy*, which follows, being simply the Stanhope body hung off on elliptical springs. Up to this period American art was largely indebted to European taste for its fashions, especially where the carriage was built to order. Not only did we copy their designs, but likewise used the same kind of timber and the like clumsiness in constructing the wheels. Hickory was not employed for spokes until after the invention of the eccentric lathe, somewhere about this time. It was found so much stronger than oak that it came into general use, causing an entire revolution in the construction of American wheels.

The first illustration on next page represents an *American cabriolet*.

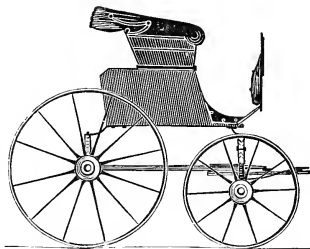

CARTER'S NEWARK BUGGY.

This, too, originated abroad, losing something of its beauty in its voyage across the Atlantic. What else could be expected when every body-maker was left to do his own drafting and provide his own patterns before he could proceed? The wonder at this distance of

time is, that he succeeded as well as he did, or that he succeeded at all. It may be profitable to compare this with the English cabriolet on page 372.

The next figure represents the vehicle we call a *sulky*. The name is said to

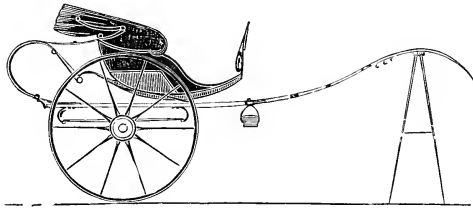

AMERICAN CABRIOLET.

have originated thus: An English physician (Dr. Darwin) found that he lost much valuable time in allowing another to ride with him when on his professional visits, so he had a carriage built so narrow that it could not be expected to hold more than one person. His disappointed friends, divining his purpose, derisively called his *improved* vehicle a

"sulky," by which name it has been handed down to our times. American ladies, piqued at the exclusiveness with which the men use it, have named it "the selfish." It probably is nothing more than a whisky in a simplified form, and is a

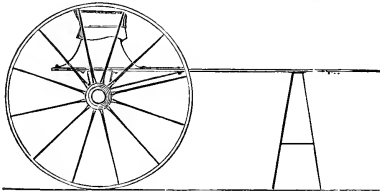

SULKY.

much less expensive article of manufacture. They cost from seventy-five to a hundred dollars.

We have already described the accommodation and the sociable, two vehicles heretofore placed at the service of the New York public. Twelve years had already passed since Lafitte in Paris, and two since Shillibeer in London, had introduced vehicles of the kind into those two populous cities, when on one fine day in 1831 the citizens of New York were startled by the appearance on Broadway of a heavy carriage with the word "omnibus," in large letters, painted on the side panels. The unclassical reader must understand that *omnibus* is the plural of *omnis* in Latin, meaning "all"; in plain English, a "carry-all" for those who are willing to pay for a ride. This omnibus, somewhat different from the European, was designed and constructed by John Stephenson, of New York, who has since become the most famous builder in America. This first omnibus body was hung off on four elliptical springs, with

short leather braces intervening. These not fully answering the purposes intended, the builder afterwards dispensed with the perch and substituted the French platform springs for the elliptic, with such success that they have ever since been used in this class of vehicles as

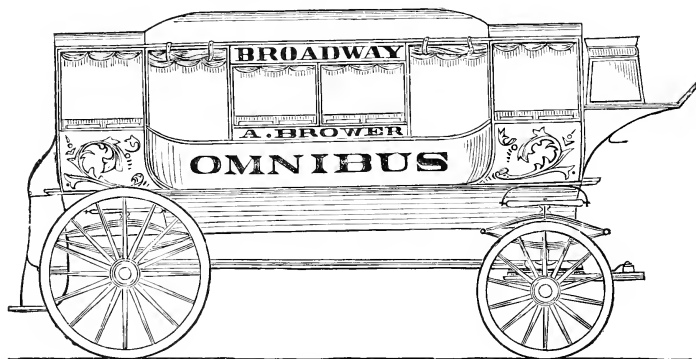

BROWER'S OMNIBUS.

preferable to all others. At first the fare, from Bond Street to the Battery, — taken by a boy standing at the rear, after the French mode, — was twelve and a half cents.

We have seen in the course of our history some account of the opposition interested parties have shown on the introduction of new vehicles for public patronage, as in the case of coaches, etc., into London. Something akin to this hostility was manifested in several instances, especially by the class Taylor aimed his diatribes against. Even the press was not backward in describing the foibles of the drivers. One writer tells us that "the character of the omnibus drivers has become brutal and dangerous in the highest degree. They race up and down Broadway and through Chatham Street with the utmost fury. Broadway especially, between the Park and Wall Street, is almost daily the scene of some outrage, in which the lives of citizens riding in light vehicles are put in imminent hazard. Not content with running upon everything which comes in their way, they turn out of their course to break down other carriages. Yesterday a gentleman driving down Broadway, and keeping near the west side, was run down by an omnibus going up, the street being perfectly clear at the time, the omnibus

leaving full twice its width of empty space on the right of its track. At the same spot a hackney-coach (!) was crushed between two of them the day before. It is but a few days since we published the account of a physician being run down near the same spot, his gig ruined, and his horse nearly so, and his own life placed in the most imminent hazard. A ferocious spirit appears to have taken possession of the drivers, which defies law and delights in destruction. It is indispensable that a decisive police should be held on those men, or the consequences of their conduct will result in acts which will shock the whole city." ¹

Again, "A ticket-boy in one of Gray's Bleecker Street stages had the effrontery to demand of a young lady one dollar for eight tickets, requiring her at the same time to pay for a small child, which is at least unusual, telling her they gave eight tickets for one dollar. Mr. Gray was informed of the imposition, and requested to return the money or the additional eight tickets; but after walking *eight times* to the Bleecker House, the friend of the lady was told by Mr. Gray that he could not answer for the honesty of his boys." ²

A few months later complaint was made that "the Broadway stage Alice Gray was driving up the street at the rate of about nine miles an hour, when the axle-tree broke and down tumbled the driver, bringing his own same self with him to the ground. What a pity it did not break his — nose." ³

Fortunately the next year (1832) witnessed a radical change in the conveyance of street passengers, in the end putting a stop to many of the abuses above complained of. The New York and Harlem Railroad Company, having laid a portion of the track from Prince to Fourteenth Streets, they placed a car thereon, named the "John Mason," to be drawn by horse-power. Mr. John Stephenson, to whom we are indebted for our illustration, claims that he was the first manufacturer in the world to build a street-car. He will see that he is mistaken, should the English claim for another Mr. Stephenson, on page 364, be admitted. This car consisted of three compartments, each holding ten passengers, entrance being had through three doors in each side, the doors at the ends, with lengthwise seats, not coming into use until

¹ New York *Journal of Commerce*, May 6, 1835.

² New York *Commercial Advertiser*, June 16, 1835.

³ *Spirit of Seventy-six*, Sept. 24, 1835.

1845. These compartments carried ten persons, five on a seat, facing each other. Seats for thirty more, reached by steps at the ends, for males, were formed on the roof, thus furnishing accommodations for sixty passengers. Much time was consumed in getting the passengers

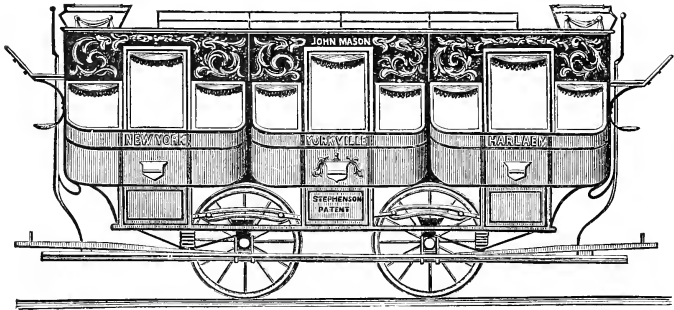

AMERICAN STREET-CAR.

on and off the roofs, sometimes these breaking down with the weight; in consequence, this mode of construction was soon abandoned. After various experiments, the present mode of construction was reached, which probably is the best that can be employed.

Some of the designs in use in 1838 have at the present time a rather unfavorable appearance. We give a specimen from the draft-book of Mr. John C. Parker, the successor of Milne Parker, to whom we have

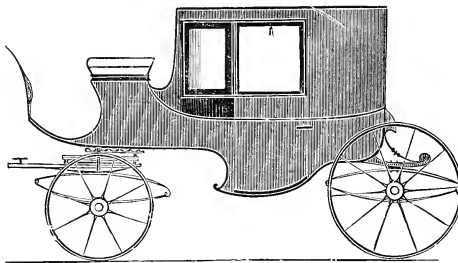

AMERICAN CLARENCE.

before alluded in these pages. This vehicle, called a *Clarence*, was in its day considered a very fine carriage, and was extensively patronized by some of the most fashionable citizens in this country. Occasion will be given to compare this with the more modern Clarence before closing this volume.

We have examined the draft-books of some of the most popular

builders of former days, and found that in design they are quite defective. The *coachee* from the Parker collection is a fair exhibit of the better class of work made in New York City at this time. Should an expert compare this drawing with the one on page 434, he will find that although this was made some ten years later, still very little progress has been made. This lack of advancement is doubtless due to the fact that the Newark carriage-builders had secured a professional designer from Paris,

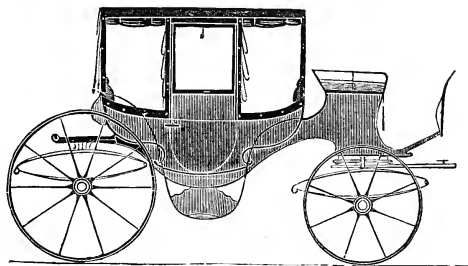

PARKER'S COACHEE.

while no house in this city had any such assistance. Wealthy citizens in those days were comparatively scarce, and the few orders then obtained for first-class work did not warrant the expense involved by employing an educated artist. Indeed, trade in the city had dwindled down to little else than repairing, when through the efforts of a single individual it took a new start. This was the late Isaac Ford, who, believing that a lighter and better class of work would find a ready sale, undertook the manufacture at 114 Elizabeth Street. His success induced others to engage in the same business, until unitedly a class of work was produced that defied competition on the part of country builders, from the simple fact that under no circumstances could they obtain a price for their buggies that would pay, even supposing that they were equally well made. The opening of the Central Park in 1856 gave carriage-building in New York a still further impulse, by creating a demand for the heavier and more expensive class of carriages from the wealthy in our midst.¹

The plan laid down for this volume obliges us to bestow some attention on the business portion of the world on wheels, and this is a

¹ The Central Park, one of the finest in the world, has an area of eight hundred and sixty-two and fifty-nine one hundredths acres, is bounded by Fifty-ninth Street on the south, One Hundred and Tenth Street on the north, located between the Fifth and Eighth Avenues, is twice the size of any in London. The drives over good roads and amidst picturesque scenery surpass any we have seen in Europe. We have given a view of a portion of the drive to accompany the initial letter of this chapter.

proper place to do so. Previous to 1838 a clumsily constructed cart had been universally in use by the butchers and grocers of New York

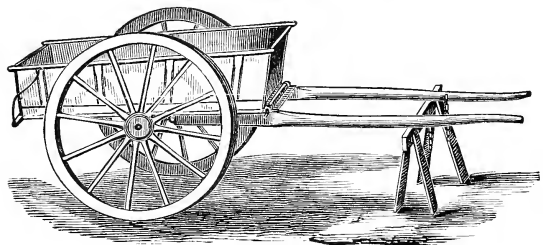

BUTCHERS' AND GROCERS' CART.

City. This answered a very good purpose when run over the rough cobblestone pavement then in vogue. But after the adoption of the Belgian pavement, a lighter description of cart took its place. This cart has continued in general use down to the present day among the market-men and butchers of the metropolis, it being a much more convenient vehicle.

Butcher boys are proverbially reckless when driving through the public thoroughfares, and giving them a lighter cart has in nowise

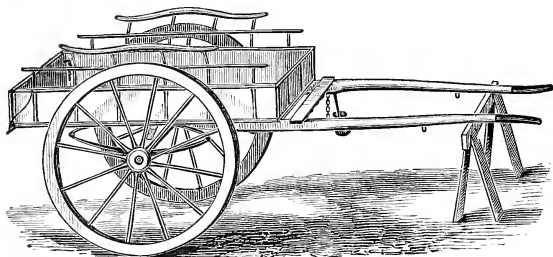

IMPROVED BUTCHER'S CART.

improved their conduct, as citizens suffering at their hands will testify.

About the same time in which improvement was made in the butcher's

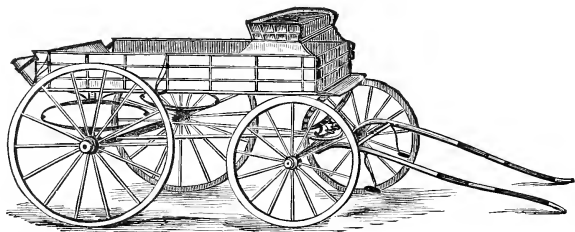

AMERICAN EXPRESS WAGON.

cart, a new style of wagon was built for the grocery-men similar in appearance to the one shown here, the

only difference being that instead of two, only one side rave ran through the middle of the body. Out of this grew the modern express-wagon, chiefly employed in transporting baggage and parcels in the principal cities. Some of these express-wagons are very handsomely finished and painted. The best made come from Concord, N. H.

About the year 1840 a new description of street-cab came into use, to the serious injury of the old hackney-coachmen neglecting to provide themselves with one. For a time they created a fever, everybody

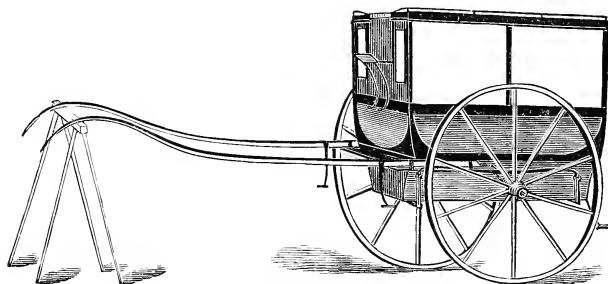

AMERICAN CAB.

wanting to take a ride in them. The originals were built by — Vanderwerken, of Jersey City, with the shafts attached to the body, the axles extending around it in front. These were afterwards improved by securing the shafts to the axle, as shown in the diagram. The most prominent builder in New York City was Joseph E. Ayres, in Mercer Street, whose success led to a lawsuit from the alleged patentee. The result was, the Jerseyman lost the suit and was saddled with the costs, the principle on which the patent was given having been shown to be old.

The annexed figure represents a *turn-over-seat phaeton*, made by John C. Parker for David Austen in 1843. This is chiefly interesting as showing with what simplicity and cheapness a vehicle may be constructed with solid sides, and at the same time make a respectable-looking phaeton, designed for either two or four passengers, as may be desirable. When in the

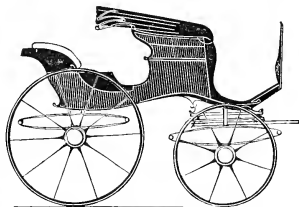

PHAETON.

mood for "cutting a swell," the "master" might hold the ribbons, while the servant enjoys himself on the back seat, *à la Anglais*.

The grocery-wagon previously noticed continued exclusively to be used until 1844, when the author of this volume built two improved wagons for Thomas K. Newton, the original vender of bottled soda-

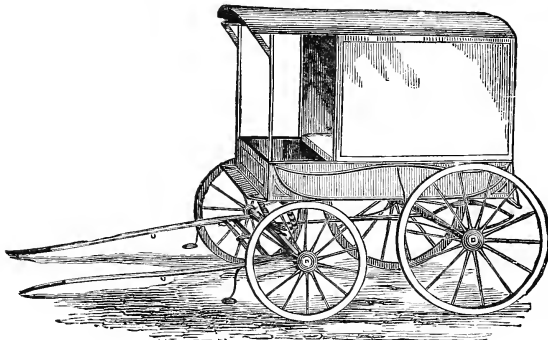

IMPROVED BUSINESS WAGON.¹

water, which are represented in the annexed engraving. The slats seen in the express-wagon on page 442 are concealed in this example by paneling the outside and lining the

inside. The moldings added to the outside give the job much the character of paneled work, which after painting and ornamenting makes a handsome business wagon, the popularity of which continues to this day.

About the year 1830 a carriage-builder in Jamaica, Long Island, New York, made a wagon for Maltby Gettson, a resident of that village, with wooden springs on the outside of the body. The body itself was a plain affair, similar to the country wagons then common throughout New England. Afterwards elliptical springs were substituted for the wooden, when a bow-top was added. The bows were secured to the body on the outside by riveting, and these again were covered with muslin and then painted. At this time it was simply termed a top-wagon. This wagon, being very commodious and well protected from the weather, attracted the attention of several gentlemen, among whom were Jonathan Sturges and George A. Cony, citizens of New York. These vehicles attracting the notice of others on the street, such was the demand created thereby that a dealer was

¹ The cuts representing this, the two butchers' carts, and the express-wagon, on page 442, have been generously lent us by Mr. J. L. Kipp, of New York City.

encouraged to place a few in his repository for sale. The novelty of these wagons, in contrast with other carriages, led to inquiries where they were made. The dealer whose interest was involved in the sale, in order to mislead, replied at Rockaway, with the full knowledge that no shop was in existence there.

It was not long, however, before the truth came out, and the following winter the Jamaica carriage-builders were crowded with orders from city customers requiring *Rockaways* for the next spring's use. Our authority for these facts—Jacob Smith, Esq., of Jamaica—tells us that some of these *Rockaways* with wooden axle-trees may still be found in that village. In 1845 the *Rockaway* had

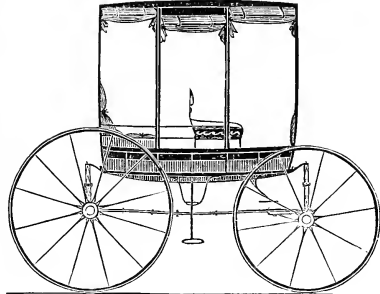

ROCKAWAY.

taken the shape seen in the above illustration from the Parker Collection, retaining scarcely a semblance of the original of fifteen years' earlier design. How Mr. Parker came to build these carriages is thus told by Mr. Smith: "Some years ago Mr. Parker visited Jamaica and ordered a *Rockaway* body made without painting, saying that a fractious horse had run away with the wagon of a customer in the city and broken it, adding that he had not time to make one then. This, however, was merely an excuse, resorted to for the purpose of obtaining a pattern from which to build. After a few years this pattern went to

New Haven."

There is another carriage built, sometimes called the *Germantown Rockaway*, which we have already noticed in its proper place. Our illustration represents a *Germantown* as made in 1847. Of the earlier drawing

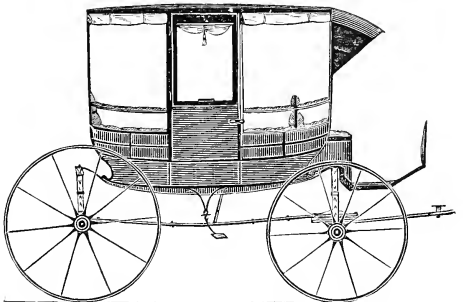

GERMANTOWN.

we have not been able to procure a copy, but the one under consideration bears so strong a resemblance to the foregoing, that, did we not entertain the highest regard for Mr. Smith's report, we might be induced to think that the Long Island was but the counterpart of the Germantown Rockaway, which Mr. Junkurth assures us was invented as early as 1816, thus anticipating the former some fourteen years.

After our war with Mexico, and the cession of California to the United States in 1849, and its golden treasures had been unearthed to the enrichment of many, a new market was opened to various branches of manufacture, among them a costlier class of carriages than had hitherto been in general request, since the success of trade had created millionnaires out of citizens previously poor. These rich men, as is quite natural, concluded that they must make a show corresponding with improved circumstances by "setting up an establishment." To do this properly called into use more extensively a heavier class of carriages of the coach variety. At first these were of faulty design,

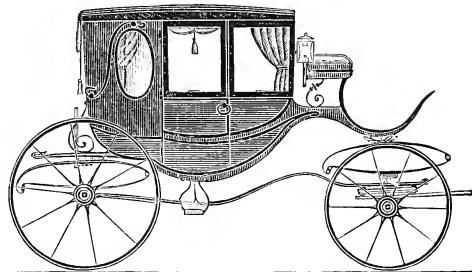

SOUTHERN COACH.

compared with those now made. A specimen is shown in the annexed figure, which previous to our Civil War found extensive sale in the Southern States and Mexico. The gaudy trimmings used in finishing were in direct antagonism with the laws of good

taste, although accommodated to the demands of Creole gaudiness and Spanish finery. The belligerency, which was fatal to work of this description, had good effect, as it turned the attention of manufacturers in another direction, where more tasty and a better class of work was required. Statistics show that in 1850 there were 1,822 carriage manufactories in the United States, employing some 14,000 hands, and producing carriages amounting to \$12,000,000.

The next figure represents a *cut-under buggy*, with stick seat, that was very popular at this time. This cut-under somewhat weakened the body, the only advantage gained being that it permitted a shorter

turning of the vehicle in narrow streets, making it more practical for men of business than any previously in use. This is the most that can be advanced in its favor, the taste with which it originated being of a questionable character, notwithstanding its popularity for a season.

No historical work like ours would be complete did it omit recording the wrong done to free industry by what has been technically known as the "perch-coupling."

We give it as briefly as possible for the benefit of posterity. On the 17th of December, 1850, Edward and Charles Everett, of Quincy, Ill., applied for and obtained letters-patent on a coupling, a drawing of which is shown.

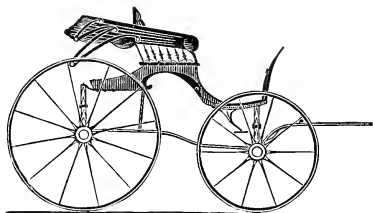

CUT-UNDER BUGGY.

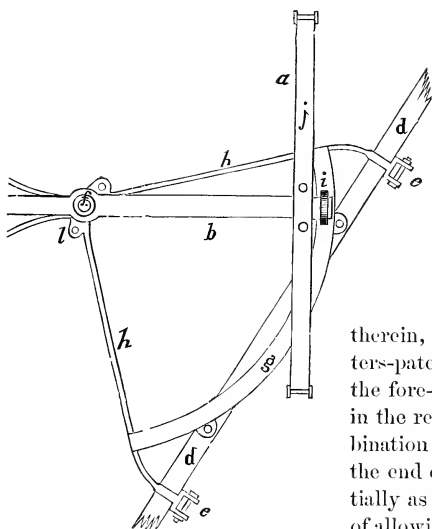

EVERETT'S PERCH-COUPLING.

Under this patent, through an agency, the Everetts disposed

in this diagram, *d* represents the front axle; *b*, the perch; *e*, shaft jacks; *f*, the point on which the fore axle turns; *l*, the ball and socket joint; *g*, the circular plate on which the ball traverses; *h*, *h*, the radiating arms supporting the circular plate; *i*, friction roller; *j*, the spring. They say,

"What we claim as new therein, and desire to secure by letters-patent, is the joint on which the fore-carriage turns when placed in the rear of the fore axle, in combination with the segment, in combination as described, for the purpose of allowing the carriage to be turned in a small space, without having the fore-wheels to run under the body, or to interfere with the hind-wheels."

of a number of shop-rights to construct carriages on their principle, by which operation they placed in the hands of many builders a Pandora's box, from which since has emanated a flood of sorrows, as will be

shown in the sequel.

On the 23d of December following, about eight days after the Everetts' patent was issued, Gustavus L. Haussknecht, an emigrant from Germany, who had located in New Haven, Conn., forwarded to Washington the model and specification, similar in design, for the "Running Gear of Carriages," the same after examination being rejected on the 15th of February, 1851, as interfering with the patent claimed by the Everetts. A second application was more successful, and on the 16th of December, 1851, nearly a year after the date of the Everett patent, Haussknecht obtained his letters-patent, the absurdity of

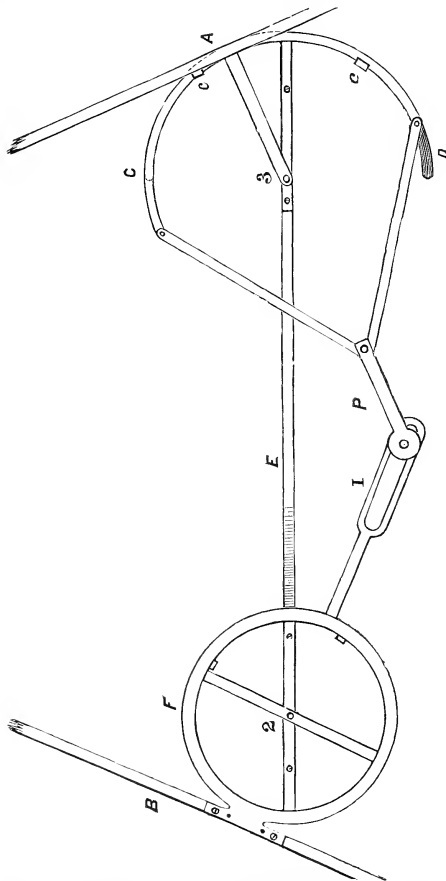

HAUSSKNECHT'S PERCH-COUPLING.

which is amply shown in the diagram, of which a sectional view of the under side is annexed. Here *A* represents the axle-tree; *C*, *D*, the fifth wheel; *E*, the perch; *c*, *c*, the hooks which lock the fifth-wheel

plates; *F*, the sixth wheel bolted to the under side of the hinder axle-tree; *I*, *P*, a toggle-joint; numerals 2, 3, showing pivots on which the apparatus operates. The following are Haussknecht's specifications: "What I claim as my invention and desire to secure by letters-patent is, *first*, the employment of segments *C* and *D*, and fifth wheels *F*, *C* (or parts corresponding thereto), attached as described; the segment, *D*, and fifth wheel, *F*, working on pivots between the front and hind axle, such parts acting in combination with *I*, *P*, constructed as shown and described for coupling the movements of two axles or turning appurtenances, for the purpose set forth." A brief comparison will answer to prove this latter the mere plagiarism of the former, which ought to have led to its rejection at once, and would have done, had not the examiner been influenced by political considerations, as is alleged. In order to get over the difficulty, Haussknecht subsequently made application for a new patent, in which he disclaimed every improvement claimed in the old, of any practical worth. He on this occasion said, "I do not claim these parate use of one segment on which the perch rests, neither do I claim two pivots attached to the body; but what I do claim as my invention, and desire to secure by letters-patent, is the placing the pivot in the rear of the fore axle, in combination with the two sets of segments in circles, viz., segments *A* and *D*, . . . or their equivalents, substantially as described." This diagram shows an under-side view of Haussknecht's second model for his later patent, obtained Dec. 16, 1851, a year later than the date of the Everett patent. *A*, *A*, are segments of the fifth wheel, of which *a*

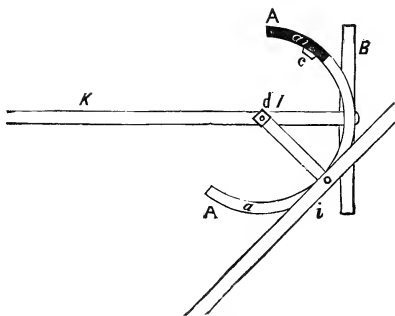

ANOTHER HAUSSKNECHT COUPLING.

is the bottom plate, and *a* 1, the top; *d* 1, the pivot; *c*, stop-hook; *B*, head-block; *i*, axle; and *K*, the perch.

It now remains for us to show how great a wrong was inflicted on the public in connection with these couplings. We have already mentioned that the Everetts sold by agency numerous shop-rights throughout the country. In the diagrams supplied to their customers, the

friction-roller, *i*, in the Everett coupling, was entirely ignored, and a curved head-block substituted, fitting the circular plate, *g*. Of this, however, the victims were not advised, this *blissful* state of affairs continuing down to Jan. 15, 1857, when Haussknecht once more surrendered his letters-patent, asking for new ones with amended specifications, claiming, (1) the combination and arrangement of the pivots in the rear of the fore axle, and the segments with the perch and head-block on the perch cross-bar, of carriages having perches as hereinbefore described, or the equivalents thereto, for the purpose of enabling carriages to turn in a shorter space than by the common mode of coupling, with perfect safety; (2) the additional set of segments, or their equivalents, the pivots placed perpendicularly above the lower turning-point, to be employed where the springs are fastened to the axle, and move with the same. The drawings which accompanied these specifications are so nearly identical with that claimed by the Everetts, that we are surprised at the manifest stupidity exhibited in granting this patent.

As early as 1855, Haussknecht declared that his rivals' patent was an infringement on his own, and under such pretenses had commenced reprisals on the carriage-builders, demanding money, and getting it where he could frighten; where he could not do so, following the victim with a lawsuit. At this point justice required that the Everetts should have come forward and defended their customers, but in this respect they were culpably negligent, the consequence being that, *under the color of law*, Haussknecht obtained large sums for infringements on a patent which he had no legal claim to, as has since been proved in several courts of law.¹

About the time that Haussknecht received his undeserved letters-patent, Uel Reynolds, a New York carriage-builder, invented a clip king-bolt for vehicles, which has been universally adopted for light work in America, but which he neglected to patent until too late. Circumstances prove that Mr. Reynolds did not at the proper time estimate the real value of his invention. Had he done so and secured



REYNOLDS'S KING-BOLT.

¹ The interested reader will find a detailed history of this matter in the sixth volume of the *New York Coach-maker's Magazine*, published by the author, under the heading of "Perch-couplings Dissected."

the patent, he would have found in it a mine of wealth. This invention was afterwards named and given to the world in the pages of the "New York Coach-maker's Magazine." Several years afterwards (in September, 1865), when it had become an article of commerce and in universal use by all the carriage-builders in this country, one James Phelps, of Red Creek, N. Y., applied for a patent on the original invention of Uel Reynolds, and no doubt would have been successful, had it not been for the Magazine exhibit from the very first. Afterwards, strange as it may appear, he did succeed in patenting the projecting shoulders or bearings, *B, B*, resting on the axle at the fork of the king-bolt, these also having been used by several carriage-builders previously. After the governmental indorsement of the simple bearings, as being "new and useful," the way was open for operation. The persistent patentee had only to assign his claim to some enterprising individual, which was done in this instance; how injurious to the craft may be gathered from the pages of the "New York Coach-maker's Magazine." These two examples show that the examiners-in-chief at the Patent Office are too lax in duty, and ought to exercise more caution, unless they design becoming the willing abettors of all that is wrong, under the sanction of law.

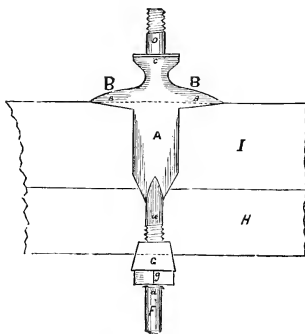

PHELPS'S KING-BOLT.

By placing the two patent cases in juxtaposition, we have been obliged to anticipate chronology some ten years. We now go back to 1855, when the buggy represented by the next figure was in fashion. This was named in honor of Jenny Lind, and in remembrance of her visit to this country. This buggy has a wooden dash-board, and the top is secured to the seat by means of a shifting rail, — an invention that came into common use in 1838 or 1839. Like the other improvements before noticed, these rails, in the hands of speculative adventurers, were at one time the cause of much trouble to manufacturers, the history of which will be found in the second volume of the "New York Coach-maker's Magazine," published by the author.

The last engraving on this page represents a physician's *close Rock-away*, or phaeton, so contrived as to protect them from the inclemencies of the weather while engaged in pursuit of their calling. The bodies of these vehicles were usually paneled work, but much labor was saved by having the hind quarters formed from the solid plank. The front portion was closed by a door attached to a bar under the roof by means of three hinges so contrived that when desirable

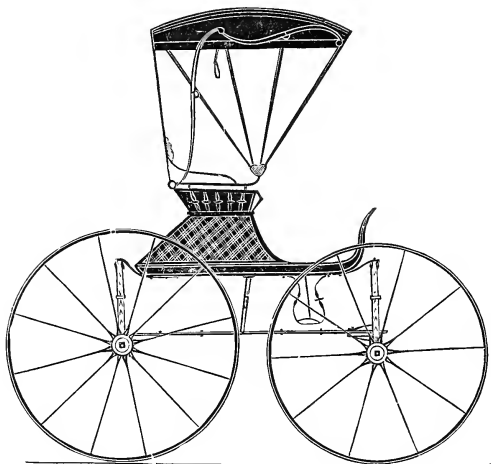

JENNY LIND.

this front was swung up on the inside and secured to the under side of the roof by a catch. Thus raised in fine weather, the man of physic had an unobstructed view in front; but with this door closed and the side curtains down, he was able to defy all kinds of bad air. The Everett coupling applied to this vehicle was extremely useful, but the trouble occasioned by the legal proceedings previously described was fatal to the improvement. And here we may note, that in order to destroy the *value* of any invention, let the inventor give the carriage-builder summons to a law court, and he will immediately cry it down, advising his customers to leave it alone if they would avoid the same trouble.

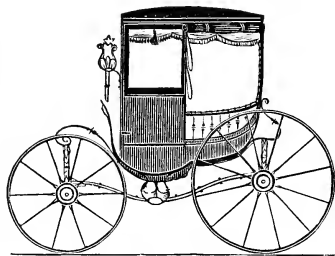

PHYSICIAN'S PHAETON.

The next design represents that which may with propriety be

denominated the standard buggy, the square form under different trimmings having always met with favor among the American people. Strenuous efforts at popularizing other fashions of the buggy kind have been made, as will be shown in the course of this chapter, and yet with a few exceptions they have lost caste with the close of the year annually. The distinguishing traits in this buggy are the oval moldings of split rattan on the side panels, and a plaided leather boot covering the space around and below the seat.

About this time (1855) one Sprout, of Hughesville, Pa.,

obtained the patent for a combined spring, some idea of which may be learned from examining the *road sulky* to which we have applied it. A Western editor, led astray by money potency, informs us that "the easy motion and bracing position of this spring is peculiarly adapted to vehicles of this denomination. No sensible man will ever be satisfied with an elliptic spring for a sulky after he has rode on one of these." As elliptical springs still maintain their former popularity, the inferences are that they are either the best in use, or else mankind

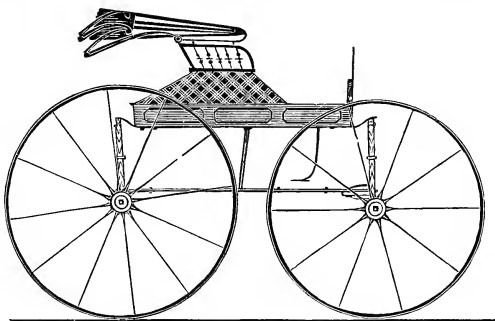

SQUARE BUGGY.

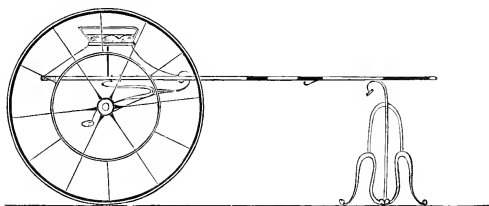

ROAD SULKY.

are generally in a demented state of mind! The wheel is known as Oliver's patent. Of it the "Scientific American" said, "The improvement consists in the peculiar construction of the wheel, whereby light or small hubs may be used, and a more durable and stronger wheel made than the ones now in use."

A more reckless recommendation was never penned. This wheel was

not only very weak, but heavy, as compared with the old, as any practical builder would discover on sight. It soon fell into disuse.

On page 333 reference has been made to the complex axle and box invented by Collinge in England. In America, as a substitute, William H. Saunders introduced the mail axle, for a long time popular with American carriage-builders. In large hubs it answered an excellent purpose, as, like the Collinge, it was air-tight and noiseless, excluding dust, and preserving the oil lubricator in its fluid state for a long time, but it was unsuited to the small hubs used in the lighter

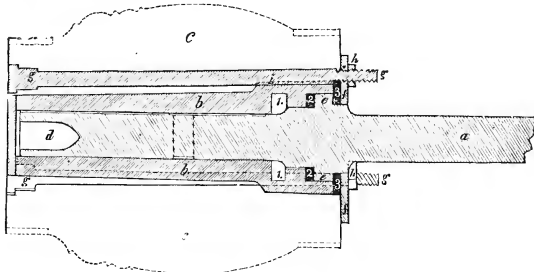

STRATTON'S PATENT MAIL-AXLE.

American carriages. To obviate this defect the author of this volume, then in the trade, in 1856 invented the improvements shown in the annexed diagrams. The first represents a longitudinally divided section of the hub and axle, *a* representing the axle; *b, b*, the box; *c, c*, the hub; *d, 1, 1*, oil-chambers; *e, e*, axle shoulders; *f, f*, collar-plate; *g, g*, bolts; *h, h*, nuts; *2, 3*, leather-washers on each side of the shoulder. By running the bolts in grooves made in the swell of the box, the flange was reduced in diameter, and a guide was obtained for boring the holes for bolts, the bolts inserted answering as wedges to the box. This invention, which Mr. Saunders pronounced an important improvement, was soon after superseded by the plain axle and nut at the outer end, simply because the stable-men, for lack of care in screwing up the nuts, stripped the thread from the bolts, rendering patent axles too expensive a luxury for daily use. In heavier carriages, less used, they still maintain their popularity to a limited extent.

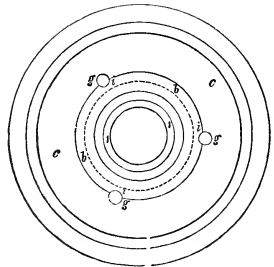

MAIL-AXLE COLLAR-PLATE.

A wagon which for a long time has been and still is a favorite with many, is represented by the next figure. It is called the *Concord wagon*, in honor of the town in New Hampshire where it originated. The body differs but little from the ordinary country wagons formerly used in New England, as may be seen by comparing it with the wagon on page 422. The peculiarity consists in the arrangement of the springs, which extend from the fore to the hind axles, the ends being secured thereto by shackles which allow of free action under pressure. Some persons claim that they are capable of carrying either a light or heavy load with equal ease and comfort.

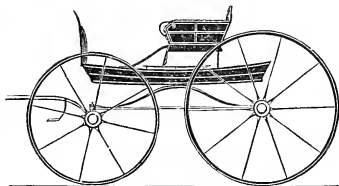

CONCORD WAGON.

Another wagon of the cheaper class is represented below. It is known as the *New Rochelle*, after a town in Westchester County, New York, originating somewhere about the year 1858. Originally it was

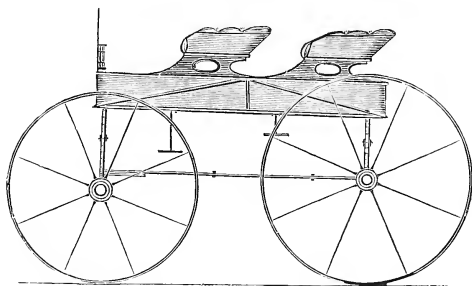

NEW ROCHELLE WAGON.

hung off without springs, but in later times these have generally been added. The year 1857 was what is known as a year of panic, many of the most business-like and enterprising men having been brought to poverty. To meet this state

of affairs this vehicle "was brought out," and became quite popular.

The first design on next page represents the *Fenton Rockaway*, thus named in compliment to one of the governors of the State of New York. This vehicle, having no door in the side quarter, is furnished with a turn-over seat in front, to facilitate the entrance of such passengers as intend to occupy the back seat. One horse is capable of drawing a vehicle of this weight, constructed with curtains for the sides, but two are frequently employed where show is one of the principal objects.

The second figure on this page represents a two-wheeled *pony cart*, intended for a light horse. It was at one time a very popular vehicle

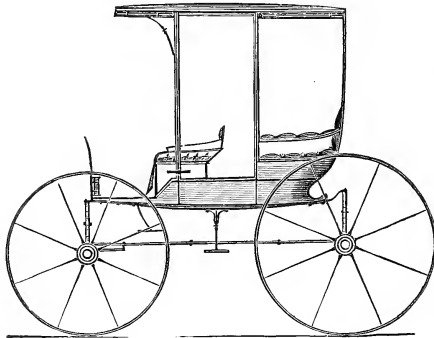

FENTON ROCKAWAY.

with the ladies at Newport, R. I., and other watering-places. We have on former occasions, when it was fashionable, seen it running in the Central Park. As will be observed, the axle-tree operates *through* the body, by which contrivance it is made to hang very low, consequently it is not easily upset.

This, like all other two-wheeled vehicles, was hard for the horse, too much weight being laid upon his back, when loaded. The *pony phaeton* has supplanted it.

A pony phaeton of the most aristocratic description is shown below, having a servant's seat behind, the seat and

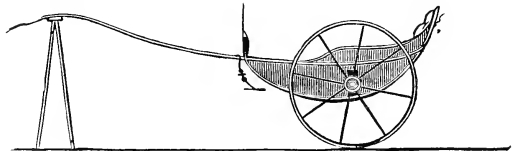

PONY CART.

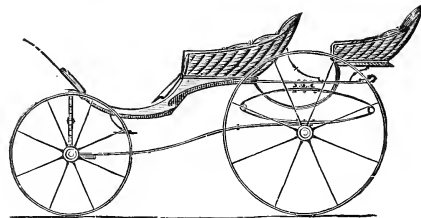

PONY PHAETON.

larger portion of the body consisting of basket-work. Although a very popular vehicle with the ladies at our summer watering-places, it is not American other than by adoption, having originated in France. How much American ingenuity has improved the European design may be learned by comparing it with the same in the chapter devoted to French art. An

enthusiast, in noticing these phaetons, in a letter from Newport, says, "The ladies' turnouts this year are very graceful and pretty. . . ."

The lady handles the ribbons, gentlemen being mere passengers, and idle Jehus sit with folded arms behind." It has been estimated in former years that more than eight hundred turnouts have been in use annually at Newport. More recently Long Branch and other summer watering-places have lessened the number. A Boston lady has pronounced the drivers, whether women or men, witless snobs.

The next is known as the *gentleman's road buggy*. It was introduced by Messrs. Brewster & Co. in 1863. Contemporaries in the trade, from jealous motives, called it a "coal-box," a name by which it is still specified. It took two entire seasons to popularize it, but when it *did take*, it took well. The ornamental figure cut in the side panel originated with the Wood Brothers. This scroll, in gold on a black ground, looked well, and made a very pretty ornament. They cost about three hundred dollars.

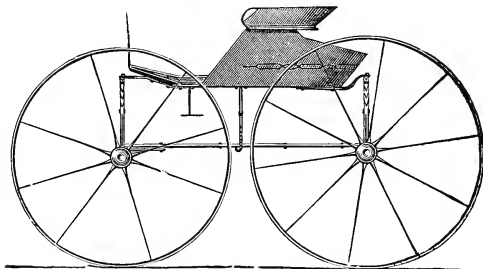

GENTLEMAN'S ROAD BUGGY.

The next figure represents a *six-seat Rockaway*, quite popular as a family carriage, where *paterfamilias* elects to act the part of driver in person. In the opinion of certain aristocratic American ladies, an imported "whip" is very obnoxious when "stuck" in front of a vehicle. To meet such cases a movable glass partition is used to divide the front seat, and leave the driver "out in the cold." These vehicles are frequently mounted on platform springs, but when finished as in our example are less costly.

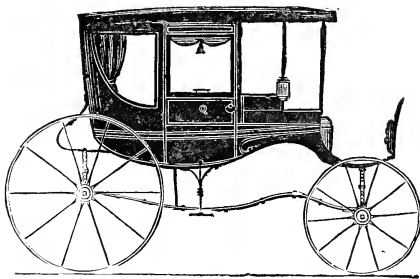

SIX-SEAT ROCKAWAY.

We now come to the American *Clarence coach*, with a rounding

front, metropolitan boot, and coupé front-pillar. The boot is understood to be the invention of the late Mr. F. R. Wood, of Bridgeport, Conn. The Berlin-shaped window in the hind-quarter was at one time very popular. This vehicle being mounted on platform springs, without a perch, it may be

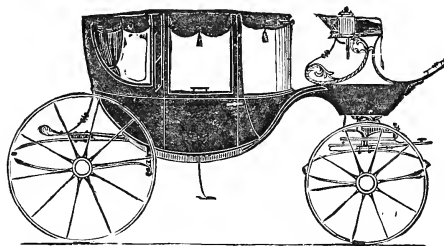

AMERICAN CLARENCE.

be turned about within the compass of its length,— a very desirable convenience when the coach is used in narrow streets.

At the period of which we write (1863), in New York City alone, there were about 13,562 vehi-

cles of all kinds. Of these, 5,000 were private carriages and wagons, 558 omnibuses, 954 hackney-coaches and coupés, 255 express-wagons, 416 wood and charcoal wagons, 278 junk-carts, 5,374 public carts, and 724 dirt-carts, besides an uncounted number of hand-carts and other business contrivances mounted upon wheels. Add to these the baby-wagons, and we have a perfect list.

This same year a law passed by Congress — with the object of obtaining the means wherewith to put down the Rebellion in the South — came into effect, compelling all manufacturers to report and pay into the treasury three per cent *ad valorem* monthly on all new work. In the construction of carriages, many articles which had already paid a tax were used, making the actual tax to the manufacturer amount to fully five per cent. This novelty in legislative action was the cause of loud complaint on the part of the public, since it entailed great expense upon all who indulged in such luxuries as carriages and some other industries.

The figure annexed represents a four-passenger extension-top cabriolet, mounted upon elliptical springs in connection with a reach. Al-

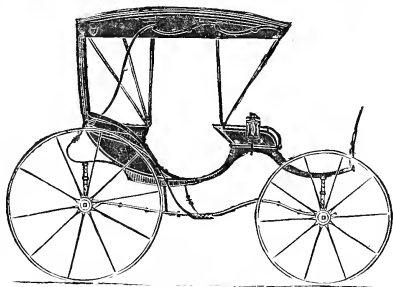

CABRIOLET.

though of European origin, this cabriolet has some improvements decidedly American, such as the extension top, etc. For a light and airy family carriage for persons of modest means, this is well fitted, five or six hundred dollars only being required for the purchase.

The next illustration represents a *caleche*, by some improperly called a "brett," the diminutive of "britzscha." This vehicle is mounted on combined springs, C and elliptical. For summer service when first introduced this vehicle presented advantages unsurpassed by any other in America, but since that time it has to a great extent been supplanted by the more aristocratic landau. The reader's

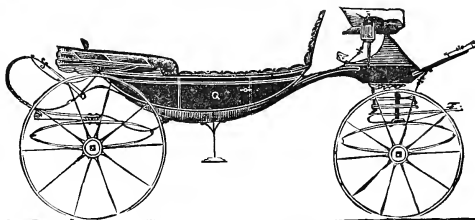

attention is directed to the style of the boot, that portion of the front directly under the driver's seat, which is a combination of the old one of previous years and the metropolitan, as represented on page opposite. The combination of springs in this carriage is termed "double suspension" by the trade. The first carriage hung up in this country as above, without a reach, was built in Bridgeport, Conn., by the Wood Brothers, in the autumn of 1857, after a European design.

On the 30th of June, 1864, Congress passed an Act assessing the gross receipts earned by the proprietors of stage-coaches and other vehicles engaged in the transportation of passengers and property for hire, or in transporting the mails of the United States, a duty of two and one half per cent, payable monthly to the assessor of the district in which the business was transacted. Contrary to the expectations of all, none of the taxes laid on carriages or their use seemingly injured trade, but otherwise unexpectedly gave it life such as it had never had before. In the New England States alone, where in 1859 there were only 1,564 shops, these in 1864 had increased to 1,649, showing that, although deprived of the Southern trade, other markets had been found for the encouragement of enterprise, more than equalled by that lost by the Rebellion.

The circular carriage-drive around the Central Park was completed in 1864. This drive furnished New-Yorkers with a fine road amid

diversified scenery unsurpassed anywhere. At this time the Rockaway, before noticed as a simple wagon, had become the elegant vehicle

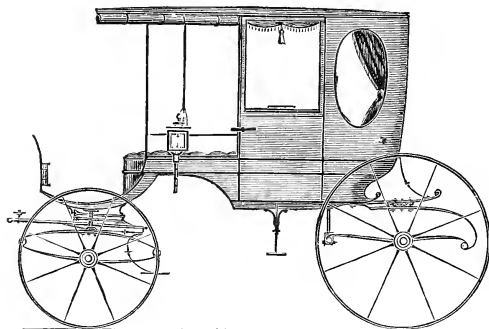

CUT-UNDER ROCKAWAY.

illustrated here, which for a family carriage, purely American, has seldom been excelled. Cut-under as this is, and mounted upon platform springs, it not only is turned about with facility, but is likewise an easy-riding carriage, whilst at

the same time the passengers, six in number, are sheltered from sun and storm quite effectually with the side curtains down and the glass partition on the front seat in its place.

The omnibus, which we have chronicled as having been introduced into this country in 1831, had now, at the end of thirty-four years, assumed the form represented in the annexed engraving, chiefly the work of John Stephenson, Esq., who for many years has been the only builder in New York City. The

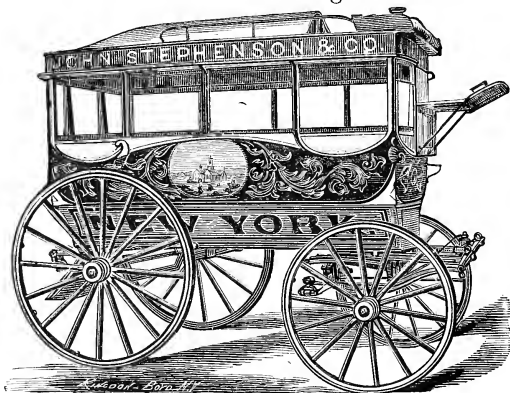

MODERN OMNIBUS.

improvements made in these vehicles by Mr. Stephenson have been numerous, and the faithfulness with which they are constructed has given the manufacturer a world-wide reputation in this special department of trade.

The next illustration represents a *gig phaeton*, which for many years has been a favorite with American physicians and business-men in the larger cities. Recently some of the doctors have used buggies as being somewhat lighter; but these have not been found as convenient, either when mounting or dismounting, as the discarded phaeton. Until something better than the phaeton is found, it must continue to be a favorite among the men of pills and other prescriptions. In this year (1867) the joints of carriage tops, which previously were curved, were put on straight, as in our illustration: a small matter, some may think, but an important one notwithstanding, when its efficiency over the old one is considered.



GIG PHAETON.

During the year a distinguished Boston surgeon invented and ordered built for his own use a vehicle which a friend describes as a sort of chaise, with wheels five feet in diameter, cranked axle, thorough-braces, and wooden springs, strapped to the shafts in a novel manner. The body, a sort of buggy kind, was fitted with a top, having a place for professional instruments made at the back. The learned doctor called it a *monalos*, from a Greek word signifying "alone," as it was of the sulky class, intended for one passenger only.

The next engraving represents a *canoe phaeton*, and differs in some

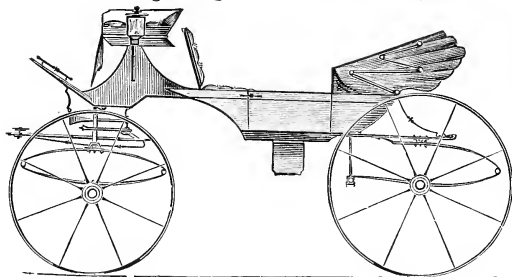

CANOE PHAETON.

respects from any other found in this volume, in fact, being a combination of the brett and phaeton. This in its day was a great favorite with New-Yorkers in their afternoon visits to

the Central Park, until another candidate for favor appeared in our

streets. This was the *demi-landau*, represented with the head down and the circular glass front removed. This carriage is much lighter than a landau, and has many decided advantages over the coupé, one

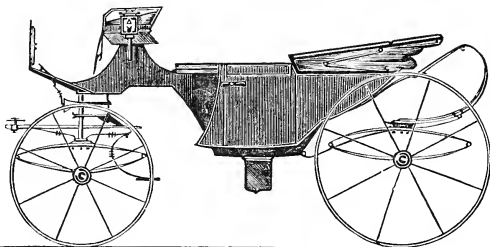

DEMI-LANDAU.

of which is that it is more airy. There is, however, this objection to all heads covered with leather, that when they get a little in years, just like the human family, they become wrinkled beyond relief,—a general complaint with all tops supported by bows. At the time of which we write this *demi-landau* is *the favorite among "upper-tendom."*

The next drawing represents a vehicle, which we have said originated in France. The word "coupé" French scholars interpret as signifying "to cut in two," or be separated, in the sense in which the head of the wasp is joined to the body by a ligature. The portion which gave rise to the name is that which connects the front seat and boot to the main portion of the body. The features of note in this example are the lightness in the boot and the straight lines with which it is constructed. Coupés are special favorites with American ladies in their shopping expeditions and social calls upon their female acquaintance. The scroll platform-spring at the rear, of which an enlarged view is given on next page, possesses, when shaped as here shown, the qualities of double-action, having the full advantages of a lengthened upper half, which to properly act should be connected with the pump-handle by a knuckle-joint, instead of the old frame-work usually employed. For coupés and the lighter class of carriages this makes a graceful and easy-riding spring.

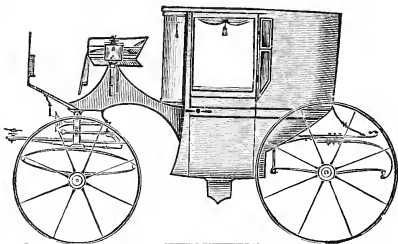

CIRCULAR-FRONT COUPÉ.

The second illustration on this page represents a six-passenger Rockaway, with coupé standing pillar, glass-front quarter, and book-step. It is constructed by combining the coupé and Rockaway, — the back being coupé, the front Rockaway, — the combination creating a novelty, which first appeared in the "New York Coach-maker's Magazine," published by the author in 1866, during our Civil War. It makes a more aristocratic carriage, and a far more convenient conveyance for the family in

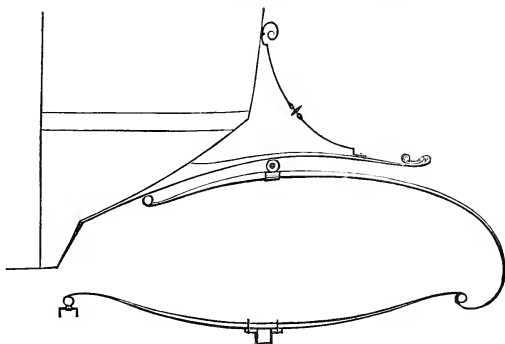

IMPROVED SCROLL-SPRING.

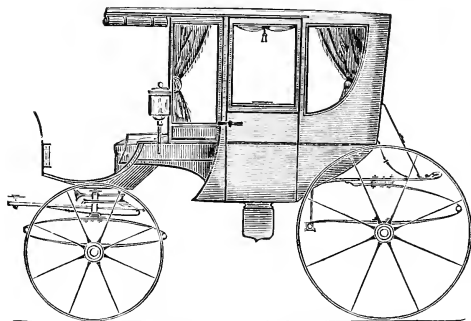

SIX-SEAT COUPE-ROCKAWAY.

frosty weather; besides, the owner may drive, with a greater show of respectability than he could if perched on a dickey-seat.

The *three-quarter Clarence* is represented in the first illustration on next page. This, too, is suspended on springs in combination,

a new feature being the oblong window in the hind-quarter. The improvements of the past four years may be seen by comparing this with the cut-under Rockaway (page 460). The slightly curved line at the back pillar adds much to the gracefulness of the vehicle. The diagram on next page shows how to construct the frame-work on which the C-spring of the three-quarter Clarence rests, the same being a bird's-eye view; *A, A*, representing the foot of the C, and *B, B*, the

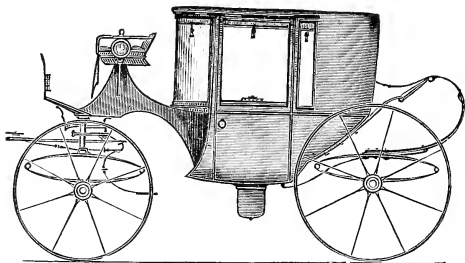

THREE-QUARTER CLARENCE.

middle portion of the elliptical springs, broken at both ends.

Several designs, all different, of buggies have already been presented in this volume, and still we have scarcely kept up with the changes in the fashions as they have

appeared, so greatly have they multiplied in late years. Two kinds are here presented. The first is called by the builder the *Bonner buggy*, in

compliment to the editor of the "New York Ledger," who had it made to order, with the Brewster patent vertical steel plates inserted in the axle-beds, whereby the inventor claims

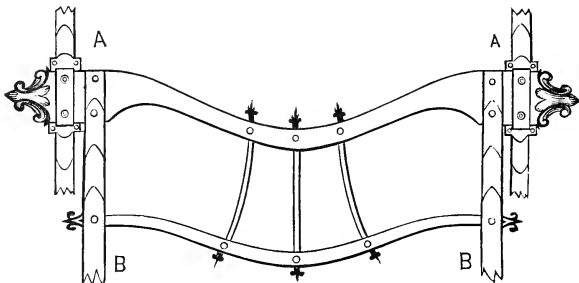

FRAME-WORK OF HIND CARRIAGE-PART.

he is able to make a lighter-looking buggy, with unequalled strength. The "Bonner style" consists in giving the sides and ends of the body more "flare" than usual, in conformity with the wish and taste of the editor.

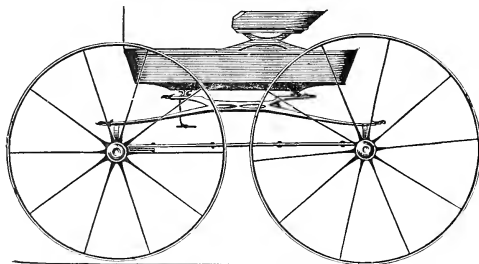

BONNER BUGGY.

There are some things which never become unfashionable, and the

remark is true when applied to the next buggy, this class of vehicles having been standard for more than thirty years. During the time, the ribbed, the Stanhope, the Jenny Lind, the coal-box, and many others with varied names have appeared, but none of them have retained the popularity accorded the square-box; and to-day, should we order a buggy for life use, a vehicle of this description would be selected, with the certainty that we should always have a *respectable* turnout for the road as long as it would last.

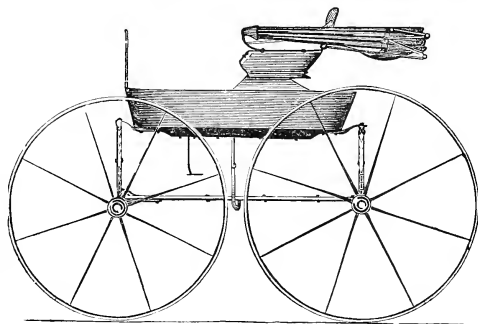

TOP BUGGY.

Within the past five years great improvements have been made in the construction of landaus. Some of these we have tardily adopted, in consequence of the limited demand for this expensive carriage in America prior to 1860. Since that time, with our accustomed diligence, we have studied to make the landau, in conformity with light-

ness, as in other carriages, a popular vehicle. Besides, we have made some striking changes, one of which is the arrangement of the door above the belt-rail, by

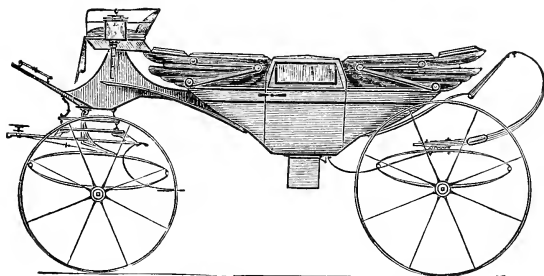
AMERICAN LANDAU.¹

which means the glass window is protected when lowered and supported when raised, the invention of Mr. F. R. Wood, on which his heirs hold a patent.

¹ For this engraving, and some twelve more preceding it, we are indebted to the kindness of James B. Brewster, Esq., New York.

In 1868 a German invention known as the *velocipede*, from the Latin *velox*, swift, and *pes*, the foot, came into extensive use in the United States, under different forms, the most popular of which is represented

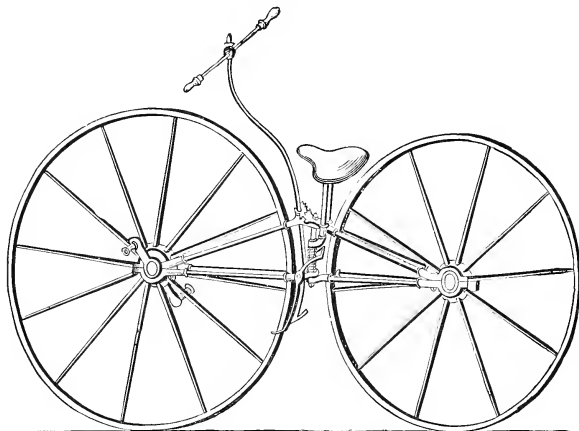

AMERICAN VELOCIPEDA.

in the annexed engraving. The original, which dates from the beginning of the nineteenth century, is the reputed invention of one Baron Drais de Saverbrun, in the service of

the Grand Duke of Baden, who died in 1851. It appeared in the garden of the Tivoli, Paris, in 1816; in England, under the name of *Drasina*, in 1818. In 1821, Lewis Gompertz, of Surrey, made some improvements in the *drasina*, which are shown in the engraving. This machine was made to turn by a lever in front, as has been the practice since. It was furnished with a handle, to be worked backwards and forwards by a circular ratchet working on a pinion with a cog-

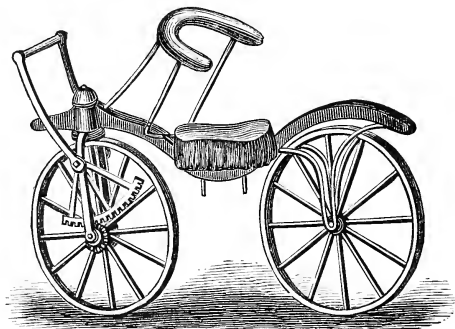

GOMPERTZ'S DRASINA.

wheel attached to the front wheel of the velocipede, as shown in the engraving. Supported by the cushioned rest while sitting on the sad-

le, the rider steered by the handle on the front wheel. The original, which dates from the beginning of the nineteenth century, is the reputed invention of one Baron Drais de Saverbrun, in the service of

dle, the rider pulled at the levers with both hands, sending the machine on its way. When thrust from him, the ratch prevented its return before the rotation of the wheel set it free. The beam connecting the two wheels on which the saddle rests was wood. Although clumsily made, it had a brief hour of popularity, as all such *boyish* inventions must have, until human nature undergoes a change.

The Hon. C. P. Kimball, in an address before the Carriage-Builders' National Association (at the time of its organization, Nov. 19, 1872), presented the following facts: "In 1870 there were 11,944 establishments in the United States, employing 65,294 persons, paying out \$21,834,355 for labor, and producing about 800,000 carriages, amounting to \$67,406,548. It is now estimated that we have built, during the past year, about 1,000,000 carriages, employing some 75,000 persons, and that the total amount of the production cannot be much short of \$100,000,000. This makes one carriage to every forty persons in the United States, to say nothing of sleighs of various kinds, of which I have no positive data; but it is safe to say they can be reckoned by tens of thousands. This, you will bear in mind, does not include the extensive manufacture of axles, springs, wheels, bows, joints, bolts, clips, leather, cloth, and the thousands of articles made in parts, that are now purchased in a partly finished state by many manufacturers, that must of course employ many thousands of men. This shows conclusively that we are entitled to be rated as one of the great manufacturing industries of the country.

"This wonderful increase of production is being seriously felt by most makers. There can be no doubt that there is danger of over-producing. New labor-saving machines of all kinds have been introduced, and every aid science and ingenuity can invent brought into requisition. The labor of days is crowded into hours; from early morn until late at night we are busy in producing. We are also great consumers, but in this increase of capital and facilities there is a possibility of overdoing the business, producing more than we can possibly consume. There are now many shops that produce in seven or eight months all they can sell in the year, leaving men, during four or five months, out of employment and out of money. This state of things cannot continue long without serious disaster to the trade."

CHAPTER XII.

THE WORLD'S EXHIBIT OF VEHICULAR ART.

“This age is a babe that goes in a cradle on wheels, and no longer in one on rockers.”

JOSEPH COOK, *Prelude to a Lecture.*

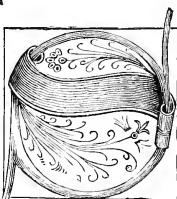

OUR Centennial year — the one in which the people of the United States celebrated its one hundredth year of existence as a free and independent Republic — has presented us with a favorable opportunity for exhibiting the progress of vehicular art among the more advanced nations of modern times. Some of the contributors to the carriage department are known at home as leaders in the trade, and therefore it is natural to suppose that in this display we have the finest collection of vehicles the Old World is able to produce. How these compare with American carriages will be seen in the course of this chapter.

Visitors to the Centennial grounds must have discovered that besides those placed in the Carriage Annex, other carriages were shown in the Main Exhibition building, standing in the center of the French department, the products of *la belle France*, sent by five different firms. These, although less showy than some others, were rich in outline and finish, showing superior taste and workmanship. Among these indisputably Messrs. Million, Guiet et Cie, 56 and 58 Avenue Montaigne, Paris, occupied the first rank, but their carriages could not enter into competition in consequence of M. Guiet, a member of the firm, having been chosen one of the jurors. The contributions from this house were seven, — an eight-spring landau, of which an illustration is annexed, a drag, a canoe-shaped landau, vis-à-vis, a coupé, mylord, and an eight-spring

Victoria. The landau, mounted on eight springs, was one of the most attractive vehicles in the entire collection, known to the trade as "double-suspension." When the top is raised the passenger is well protected from the weather; when it is down, he has an elegant and

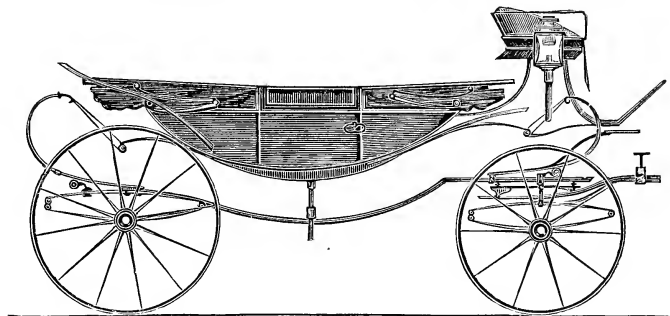

MILLION, GUIET & Co.'s EIGHT-SPRING LANDAU.

graceful carriage for pleasant-weather drive. In this respect the carriage under consideration has never been surpassed if equaled. It is charged by the English that the French put too much iron in their carriages, especially inside the bodies, in order to make them look light, when in fact, if weighed, they would be found heavier than those of their neighbors; and that they copy too much the English, — a charge they likewise bring against us.

The "New York Herald" thus noticed the remainder of the carriages of this house: "A square-fronted landau Clarence, trimmed in rich brown, with seats that can be raised at pleasure, is a marvel of fine finish and strength. As a closed carriage, with its square foot of beveled glass plates, it looks a fairy palace on wheels. A double-suspension vis-à-vis is a miracle of grace and sober elegance. It is painted in dark imperial green, with black stripes and a yellow hair-line, cushioned in dark green morocco, and trimmed with dark green cloth. An eight-spring due, with a rumble, is a very stylish and elegant park carriage. The driver's seat is removable, so that the ribbons can be handled from the inside. It is trimmed and painted in dark green. A mylord cabriolet, in brown and black, is a charming light, open carriage. It possesses a novel feature in a sliding cane seat for children, or, at a pinch, those of a larger growth. The gem of the exhibition, certainly for

ladies, is a coupé brougham in black, with a narrow yellow stripe, trimmed in Havana brown satin. Here French taste and ingenuity are displayed in the elegant details which minister to the comfort or convenience of the occupant. The drag or mail-coach exhibited by this firm is a splendid piece of workmanship. To the English must be given the credit of pioneering the refinement of the old mail-coach into the modern gentleman's drag; but there is no English work of this kind in the entire exhibition that at all approaches the drag of Million, Guiet & Co. It is as stanch, massive, and firm as the best English work, but in finish, equipment, and completeness and ingenuity of detail, it is ahead of everything English. The body is black, and the wheels and running gear a brilliant red. The inside is upholstered in dark green cloth and morocco. Outside the trimming and seating are of hog-skin, which has durability and color to recommend it. Every space in the carriage available for stowage has been made use of, and so artistically has it been done that the drag might be provisioned for a three days' cruise without showing a basket. It is filled with brakes before and behind. Even the lamps are marvels of good workmanship. Altogether the display is a credit, in the highest degree, to the firm."

Desouches, 40 Avenue des Champs Elyseés, likewise exhibited seven vehicles, — one landau, one vis-à-vis, one cabriolet, two coupés, and two phaetons, one of which was a mail phaeton. It is thus noticed in "The Hub": "This stylish mail phaeton represents a recent and very popular pattern, that was first introduced by M. Desouches, at the Exhibition of Marine and River Industries, held last fall (1875) in Paris, where it was greatly admired, and several duplicates were ordered. It has a concave and cornered front seat, and the sides and back of this seat are finished in imitation of cane-work, with black vertical moldings, placed six inches apart, as shown in the drawing. . . . The front carriage-part is the most noticeable feature of this phaeton.

The next is Binder Frères, with six carriages, viz., one vis-à-vis, one D'Orsay, one coupé, one caleche, one mylord, and a break. This vehicle is decidedly the best constructed we have ever seen, and decidedly creditable to the Parisians, with whom it originated. For park exercise, or even conveyance of passengers to railway depots in fair weather, nothing can exceed it for convenience and comfort. It is extremely popular in Paris, where a trip to the Bois de Boulogne in one is a pleasure long to be remembered. A tail-board letting down behind fur-

nishes accommodation for servants, and a brake, the machinery of which is mostly concealed, serves to check the progress of the vehicle in descending a hill. To prevent injuring the spring when pressure is applied to the wheel, a check-brace is attached to the front end of the spring, and carried to the body and there secured. This vehicle is decidedly French, and is said to have received the name "braeck" in consequence of its having originally been used for breaking young horses.

M. Mühlbacher, of 63 Avenue des Champs Elysées, also sent to the Exhibition six carriages, — two vis-a-vis, two mylords, a coupé, and a D'Orsay. This completes the Parisian list; but to these may be added four more specimens of French art, supplied by M. Gaudichet, of Vierzon, Cher., consisting of one landau, one mail phaeton, and two tandem carts. To describe these in detail would far exceed the limits of this chapter.

In another part of the main building were shown four Norwegian carioles, and an ancient sledge, undoubtedly sent us as curiosities, by Sörensen & Klovstad, and Chr. Christiansen, both firms of Christiania, Norway. The cariole having already been noticed in these pages, we dismiss these vehicles by copying Mr. Christiansen's note attached to the sledge: "This sledge was made in one of the mountain districts of Norway, in the year 1625; was kept in one family, as a piece of antiquity, until 1870, when it was purchased by the undersigned, who, in sending it over to the Philadelphia Exhibition, hopes it may afford some interest to the public. It may be bought for sixty Norwegian dollars."

Having "done" the main building, we cross the avenue in a northerly direction, and enter the Carriage Annex, where we find the English, American, and a few other national representative carriages. The English carriages, all told, amounted to thirty-six, standing double in two rows in the southeasterly corner of the building. On entering the main door, on the right stood the carriages of Messrs. Peters & Sons, 53 Park Street, Grosvenor Square, London, nine in number, viz., two four-in-hand coaches, one landau, two Broughams, one Victoria, one T-cart, one Whitechapel cart, and one ladies' phaeton, of which last an illustration is given on next page. This for a phaeton looks unusually heavy, in comparison with those of the same kind made in America, but is unquestionably the finest of this descrip-

tion in the English department, having been built to order for the wife of Baron Bramwell, an English judge of some celebrity. The

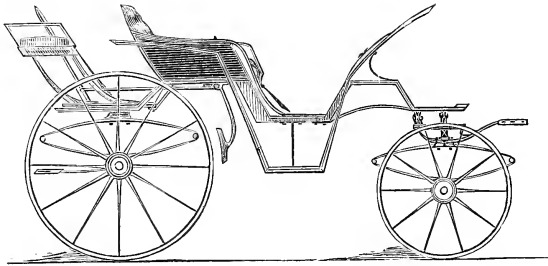

PETERS & SONS' LADIES' PHAETON.

footman's seat behind, in skeleton, makes the vehicle look much lighter than it is in reality. As may be seen in the drawing, the

phaeton is furnished with a break, — a novelty in this description of vehicle.

Next, moving eastward, we find Messrs. Hooper & Co., of 60 Victoria Street, London, with six carriages, viz., one landau, one Brougham, one park phaeton, one ladies' phaeton, one cabriolet, and a drag, the last of which furnishes us with an illustration. On a card attached the

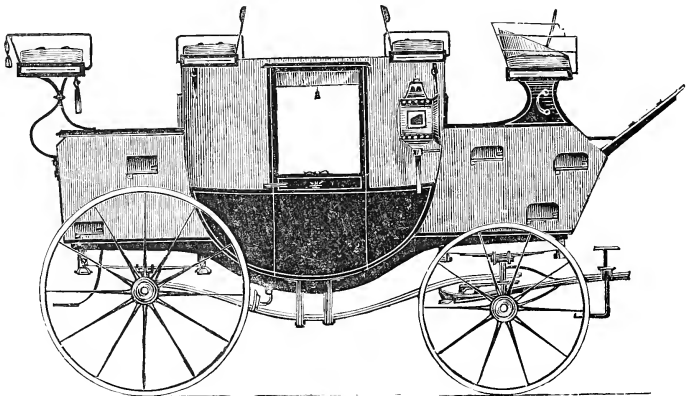

HOOPER & Co.'s DRAG.

builders tell us, "This drag is of the pattern, size, and construction approved by the members of the London Four-in-hand Club. With lightness it combines strength and solidity, indispensable to the safe

use of such carriages, the center of gravity being kept low. It is fitted with the lunch or picnic arrangements familiar to those who have attended the horse-races of Epsom, Ascot, or Goodwood; the cricket-matches — Oxford, Cambridge, Eton, or Harrow — at Lord's cricket-ground; the Oxford and Cambridge boat-races, or any of the outings from large country-houses in summer and autumn in England." At present it is very popular as a passenger-coach.

We are told by Thomas Magrath that "the coach-maker, in constructing a drag, has not so much scope for his ingenuity as he has in the manufacture of other carriages. The purchasers of drags being a select class, each one having his own particular fashion, it follows that he has to work to that particular style which his customer orders, and can only introduce such improvements in its fittings and appointments as will make it in accordance with modern taste, without materially altering its English character." To an American it seems as though a vehicle of this kind, weighing some twenty hundred pounds, was heavier than need be. As there is an increasing demand for this vehicle in the United States, we shall look with some interest for a reduction in the weight, among American builders.

These drags in England are principally used for picnic excursions, and attendance upon the races, which last are matters of deep interest with the people. A brief description may be acceptable. With the furniture complete, a drag may be considered as a very respectable hotel on wheels, and is capable of seating fourteen persons, — four on the inside, eight on the top or roof, and two grooms on the back seat. To reach the top a ladder is provided in three lengths, hinged so as to fold. This, when not in use, is stowed away under the groom's seat. Four horses are required to move the vehicle, and to provide against delays from breakage, two sets of double whippletrees and bars always accompany the machine. There are numerous racks on the inside for books, hats, etc., and handles and straps on the outside in countless variety. The dignity of the Jehu is promoted by adding a driver's box and cushion to the dickey-seat.

The kitchen furniture of a drag consists of a lunch-box full of tumblers and solid provisions, placed on the central portion of the roof, and for an additional supply of food, a wicker basket under the boot, a mahogany box of knives and forks stored between the boot and front of the body, and an ice-box. The doors being thrown open, a table is

improvised by laying a four-leaved board, joined by hinging, on the floor, crosswise. Two massive Argand lamps, fixed in front, for night travel, complete the display. The whole costs about two hundred and seventy-five guineas.

To even name all the carriages in the Exhibition would swell this chapter to a tedious length. Beside the above, Charles Thorn, of Norwich, exhibited eight carriages; H. Mulliner, of Leaming Spa, C. S. Windover, of Huntingdon, McNaught & Smith, of Worcester, each sent four vehicles; John Roberts, of Manchester, being represented by one only.

It may be proper to say that this English collection, taken on the whole, has been very severely criticised by many American visitors, perhaps uncharitably so. It cannot be denied that on first sight, standing as they did in close proximity to a very large assortment of American vehicles of lighter construction, they seemed unnecessarily clumsy, and in some specimens the painting looked rather dull. The same degree of dullness may have been attributed to the French collection, had it stood under the same circumstances with the English, alongside of the American, just turned out of the varnish-room. Whether this dullness was owing to transmission across the ocean, or consequent on exhibition at home, we are not prepared to say. At any rate, it is due on our part to mention that our English contemporaries at South Kensington, in 1873, where we saw, under more favorable circumstances, a greater variety and number of carriages, made a much brighter show in varnish and some other details. Had some of these sneerers at English carriages seen, as we did, their carriages abroad, they would have been better circumstanced for forming a correct judgment respecting the progress of art in the Old World.

In a central double row, parallel with the English, stood the carriages of several other foreign manufacturers, viz., Russia, representing three firms, with five; Italy, two; Austria, two; Belgium, one; besides others from Canada. None of these deserve special notice, if we except a phaeton which they denominate a "sand runner," by J. Lohner & Co., of Antwerp, — a fair representative of the present state of German art, eccentric and clumsy. This firm is said to have taken medals in no less than six previous exhibitions, in different cities on the European continent, principally for improvements in landaus, constructed according to the "Lohner system." Opinions as expressed by visitors after inspec-

tion of the carriages were as diversified as the nationalities represented. We overheard one enthusiastic American declare that our country had reason to be proud of its vehicular art, especially in the lining and painting departments. How much truth there may be in these respects, we leave to the judgment of others. The Centennial judges report: "Whether exhibited by foreigners or by Americans, we found in every class examined by us a remarkable average of excellence, and to one having some years of experience in this branch of manufactures (carriages, harness, and their accessories) the extraordinary progress and improvements realized during the past quarter of a century, especially in the United States, cannot fail to be striking in the extreme.

"To begin with pleasure carriages, their general appearance reveals an amount of symmetry and elegance of form, harmony of lines, taste and finish of colors and trimmings, and a variety of styles, nicely adapted to each and every purpose for which they may be specially intended, that would hardly have been dreamed of but a comparatively brief number of years since." With these remarks it now remains for us to introduce a few of the American carriages, not as possessing the more peculiar features of domestic production, but as serving our purpose, which is to show by illustration the variety in our carriage nomenclature.

The pleasure-carriages of American manufacture occupied positions westerly and northerly — in the Carriage Annex — of those from foreign lands, two abreast, filling several rows, amounting to about three hundred, including carriages, wagons, omnibuses, hearses, cars, and sleighs. We can only find room to notice a very small number in this collection, — although many of them are well deserving of commendation, — beginning with those of Brewster & Co., of New York, premising that their carriages, like those of Million, Guiet & Co., were debarred competition in consequence of their Mr. Kimball having been appointed one of the Commissioners of the Centennial Exhibition. The contributions of this house consisted of two landaus, one Brougham, one Victoria (see illustration on next page), one phaeton, and two wagons with tops, besides three sleighs. The eight-spring Victoria which we have selected for illustration occupied a central position in the Carriage Annex, attracting the attention of all visitors taking the least interest in the vehicular exhibit. In constructing this carriage the builders have adopted many features novel in this country, but

well known to the leading manufacturers of the Old World, as has been seen in this volume. It has, however, some new points, such as a removable boot and front seat, allowing it to be driven *en daumont*,

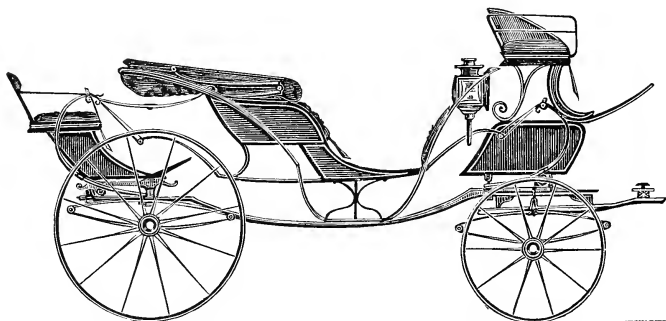

BREWSTER & Co.'s DOUBLE-SUSPENSION VICTORIA.

and a toe-board to the rumble. This vehicle is noticeable for good workmanship and fine finish. A more useful carriage for summer exercise in our Central Park is scarcely conceivable.

In the northwest corner of the collection we found those of J. B. Brewster & Co., the rival house in New York. This firm exhibited seven carriages, viz., one coach, one landau, one demi-landau, one Brougham, one Victoria, one Windsor wagon, and a side-bar wagon.

The five-glass landau exhibited by this firm is constructed on the Lohner system, to which allusion has previously been made. The dickey-seat, set on a light riser, is hinged thereto, allowing it to be turned forward, so as to let the front portion of the head fall on a line with the back. The moldings on the doors and quarters are disposed in a novel manner, imparting to the vehicle a very solid and aristocratic look, which is further improved by a fine finish.

Another New York carriage-builder, R. M. Stivers, exhibited two buggies and one Surrey-wagon, mounted on his patent "circular combination springs," which have obtained some popularity among the fancy on the city drives. Mr. Stivers calls his Surrey "the Warwick," to distinguish it from others of the same class. Access is given to those occupying the back seat by turning one half of the front seat over the near side forward wheel, for which purpose it is hinged to the

side. By adding an elevated cushion for the driver, the builder has succeeded in giving an aristocratic character to an otherwise ordinary vehicle.

Some of the observations made in relation to the dickey-seat of the last carriage are likewise applicable to the vis-à-vis of McLear & Kendall, of Wilmington, Del. This, although not designed for removal, is so arranged on the loop-iron as to give the vehicle an unusually light appearance, even for an American carriage. Both the front seat and rumble behind are quite original in design, the outlines

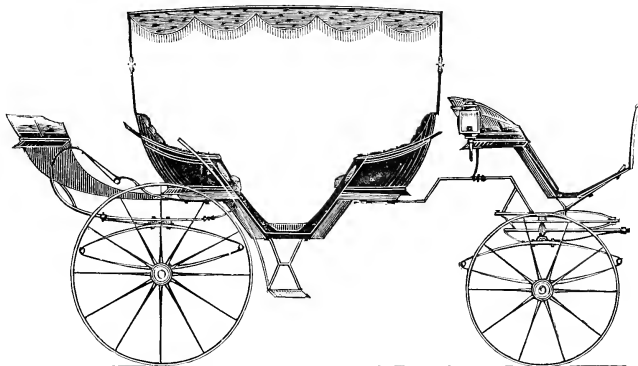

MCLEAR & KENDALL'S VIS-À-VIS.

being very happily contrived to correspond with the other parts of the vehicle. The body, lightly constructed, having a sun-top supported by iron standards, is hung off on four elliptical and two C-springs, and when carrying six persons, for which there are seats, must be easy riding. As a light family carriage for summer exercise in the Park, or where the roads are good, it cannot well be excelled.

Messrs. James Gould & Co., Albany, N. Y., had on exhibition a vehicle denominated a *drawing-room coach*, the idea being suggested by the drawing-room cars on our railroads. The novelty attached to this carriage is confined to the doorway, which is about double the usual width of that in other coaches. This doorway and the space above is ingeniously closed by three glass frames, the middle one dropping into the door, the other two remaining inside.

The last vehicle we can find room for is an American *hearse*, exhib-

ited by James Cunningham, Rochester, N. Y. In no other country are the remains of the dead borne to the grave in such costly vehicles as are the departed sovereigns of this "land of the free and home of the brave." It would seem as though, for the last twenty years, a strife has been going on among builders for the purpose of showing how many feet of plate-glass could be crowded into the limited space comprising the side panels of a hearse. What success has crowned the

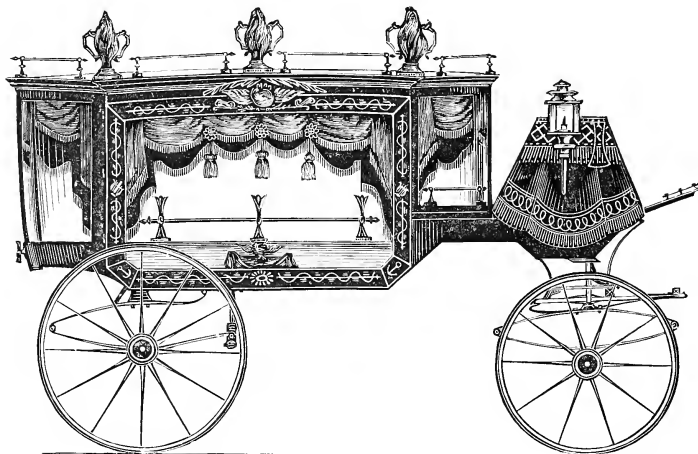

JAMES CUNNINGHAM & SON'S HEARSE.

latest effort is shown in the above engraving. Our illustration is so *explicit* that very little additional need be said in regard to this splendid carriage. We learn that it has, since it received the special award of the jurors, been sold to Allison Nailor, Jr., an undertaker in Washington, D. C., for \$3,500.

The attentive reader of this volume will now be able to form, in his own mind, an estimate of the progress made in the art of coach-building during the past few years, especially in Europe and America. If he has looked at this subject from our standpoint, he has discovered that the earlier advance in carriage-building was with the French, with whom, for some centuries, it has been progressive, and that both England and America have, in some degree, been "very good copyists." No doubt England has been, in the past, less impressible from that

quarter than America, partly from political prejudice, and partly from a natural jealousy of anything continental; whilst America, on the other hand, has for the past century been ever ready to borrow from her old political ally anything which suited her taste. The result of this course has culminated in furnishing this country with a very light class of work, while England, though somewhat influenced in this respect by modern surroundings, still clings to her old habits, and produces a comparatively heavy class of vehicles. Until the tastes of his customers change, the English workman has no other alternative than to continue on in the old rut, or find his workshop drugged by the labor of his own hands. No one can look with a mechanical eye over the pages of this volume, without being forcibly impressed with the Centennial Commission's decision,— that the general appearance of the carriages of France, England, and America "reveal an amount of symmetry and elegance of form, harmony of lines, . . . and a variety of styles" never before presented to the view of this critical world.

In order to render as fair a hearing as possible to our competitors on the other side, let us listen to what they have to say of us. The English "Carriage-Builders' Gazette" declares that "American manufacturers have confessedly a tendency to take incessant departures from accepted European styles, whether in modes of construction or design, aiming perpetually at originality; but whilst in several branches of the arts this has led to many serviceable improvements and inventions, so much cannot be said for what the French term 'carriages of luxury.' They have, however, aimed successfully at achieving remarkable lightness, and have adapted any number of English and continental patents to their purposes. Reports received by us from the Centennial Exhibition show a high standard of merit in omnibuses, railway 'express-wagons,' and tramway cars. In the higher class of equipages there is frequently an amount of glaring and costly external ornamentation which is far from being consonant with English taste. In securing lightness, with due regard to strength, there is commonly employed, in the construction of wheels and other parts requiring this combination, a native wood (upland hickory) which is admirably adapted to the purpose. The United States builders are certainly not wanting in variety in the makes they turn out, and in wagons, especially, allowance must be made for purposes of special adaptation. Large wheels and high-hung bodies would seem to be the prevailing rule, and there is a gen-

eral use of very excellent patent and enameled leathers, combining in a remarkable degree pliancy and waterproof qualities, though the same may be said of the productions of the best makers of Great Britain, France, and Belgium."

Mr. M. Guiet, of Paris, a coach-builder and member of the International Jury, since his return to France has published an individual report, from which we make some extracts, as translated for the Hub: "The number of awards granted to foreign exhibitors, as compared with those of American exhibitors, may, at first sight, appear somewhat out of proportion to the total number of their exhibits. But this is readily explained by the obvious fact that foreign nations, owing to the heavy expenses made necessary by such a distant exhibition, only sent the *elite* of their manufactures, whereas the American manufacturers, being on the spot, or at least but a short distance off, and having comparatively light expenses to bear, exhibited in great numbers, without always exercising a sufficiently strict selection. But whether exhibited by foreigners or Americans, the products of every class and nature which we examined were found most remarkable in their average quality; and whoever has for the past few years followed with interest the development of this branch of industry (carriages, harness, and their accessories), cannot fail to be struck with the extraordinary progress realized during the last quarter of a century, more particularly, perhaps, in the United States. Pleasure carriages of every style, and well adapted to the various uses to which they are intended, reveal in their general appearance a symmetry, an elegance of form, a harmony of lines, and a finish and taste in the painting and trimming, which would hardly have been dreamed of a few years since.

"Among the leading causes of this improvement, we must, first of all, mention the division of labor which now prevails in the manufacture of the various component parts of a carriage. Axles, springs, clips, bolts, and all other iron parts, which every carriage-builder was formerly compelled to manufacture for himself, with such means as he had at his command, are now produced in large quantities in special establishments, with a remarkable degree of perfection, and at prices much below the former ones. Notable improvements have also been realized in the manufacture of wheels, hubs, spokes, felloes, and bent woods of all kinds. Rims made of two pieces of bent wood have, almost everywhere in the United States, taken the place of the old-fashioned felloes

in short sections, and this improvement is daily tending to become more general abroad, especially in France and England. . . .

"In France, carriage-building, which was formerly but a small business, has become, in the hands of a few manufacturers, — thanks to the increase of the public wealth and the general improvement in the manner of living, — an industry of considerable magnitude, which deserves, for more reasons than one, very careful attention. . . . We are compelled to constantly vary our forms of styles and painting, so that a carriage which has remained on hand only a year or two seems out of fashion, and becomes difficult to sell. Out of ten sales that take place, there is scarcely one of an entirely finished carriage that happens to unite every desideratum of the purchaser. Carriages in store are almost wholly used as types or models, whose forms, colors, trimmings, and even height and track are modified to suit the amateur's fancy. . . . In the United States, on the contrary, carriages are manufactured by the quantity, after a very limited number of models of various styles, which makes easy the application of mechanical processes, and quite possible the accumulation of a large stock on hand; for this reason we everywhere saw machines taking the place of hand labor, and on the largest scale."

On the 19th of November, 1872, a convention of practical mechanics, representing some seventeen States, met in New York City, and organized the Carriage-builders' National Association, for the promotion of the interests of trade. As far back as 1862, the author, then conducting a trade journal, had advocated some movement of the kind as a protection for the industrious against the unprincipled action of certain adventurers whose sole aim was to *rob* the public, under the color of law, for individual benefit at whatever cost. The wisdom of the measures thus taken by the trade has since been amply demonstrated in various ways. It is to be hoped that all American carriage-builders will soon become members, and thereby secure some of its advantages.

The drag, which has been fully described in another chapter, has recently created some interest in America, where, under the protection of the New York Coaching Club, it has been the wonder of sporting men and the observed of all observers. The first practical

use of this vehicle was made by Col. Delancey Kane, an enterprising Englishman, by running it as a passenger coach between New York City and Pelham Bridge. It was started from the Hotel Brunswick, May 1, 1876, with a full complement of passengers, and engagements sufficient to fill the seats each day for a month in advance. Any one, lady or gentleman, willing to pay, was booked. From the moment of starting until the return trip the most intense interest was manifested by the people along the route at seeing this new candidate for public favor approach with a horn sounding as in the olden time of stage-coaching. More recently several wealthy individuals have purchased vehicles of the drag class, and, aping the European fashion, now drive through our streets in the most approved style with the greatest apparent satisfaction.



GENERAL INDEX.

- Aboo-simbel, temple at, *note*, 41; Rameses III, recorded deeds of, 39.
- Abradatus, constructs scythe-chariots, 100; is killed, 101.
- Absares, scythe-chariots at the battle of, 107.
- Accommodation, A. Brower's, 432.
- Adams's, W. B., improvements of, 573.
- Agamemnon, a noted Grecian, 89.
- Agricola, Caledonians, battle with, 251.
- Alcibiades at the race, chariots of, 124; meanness of, 125.
- Alexander, chariot-races, his opinion of, 125; battle with Thracians, 108; funeral car of, 113.
- Alliterative literature of coach owners, 365.
- Amazons, Scythian, offers of marriage, refuse, 207.
- Ambition of mankind, 17.
- Amun, worship of, 48.
- Andrews, Rich., Mayor of Southampton, builds the Queen's phaeton, 379; his system of letting carriages, *note*, 350.
- Angesilans, victor in the chariot-race, 126; sells his prisoners, 110.
- Anglo-Saxon carts, 256, 257; hammock carriage, 255; harvest-scene, 257; period, *note*, 253; truck, 257.
- Animals, wild, Cælius's fondness for, 167; various, in the race, *ib.*
- Annals of Philadelphia, Watson's, *note*, 399.
- Anniceus, a skillful driver, 128.
- Antiochus, scythe-chariots of, 109.
- Apollo, car of, 188.
- Apprentice, the Deanes', runaway, 409.
- Apuleius, quotation from, *note*, 64.
- Arabians, their chariots, Cyrus's opinion of, 99.
- Arbela, *note*, 93, 107.
- Arcera, Roman, 148.
- Archæology, quoted, *note*, 253, 263, 265.
- Architecture, Egyptian, Champollion on, 20.
- Arrian, quoted, 101, *note*, 108.
- Aristocracy, English, carriages of, 314.
- Armenians at Arbela, 107.
- Army, Egyptian, military organization of, 43.
- Art, Assyrian, whence derived, 89; progress of, 18.
- Asiatics, 99.
- Assassination, in a coach, of Duke of Orleans, 215; of Henry IV, 217.
- Assyria, chronology of, 72; foundation of, 69; records of, 73; in alliance with Egypt, *note*, 89.
- Assyrian bass-reliefs, 95; compared with Egyptian, 73; in British Museum, 74.
- Assyrian king, crosses a river in his chariot, 70; attacks Hezekiah, 85.
- Assyrians, peace treaty of, 75; war-chariots of, 73.
- Axle-tree, Ackerman's, 362; Collinge's, 333; Stratton's, 454.
- Bagdad, *note*, 94.
- Baggage-cart, Egyptian, 46.
- Baggage-rack, 433.
- Baris, or Egyptian boat, 44.
- Barouche, American, 433; English, 329; French, 357; open town, 387.
- Basterna struck by lightning, 139.
- Battle-scene from Luxor, 53.
- Bealson, Robert, road-protector of, 333.
- Beit-ualli, Nubia, 37.
- Benna, Roman rustic wagon, 179.
- Berliner, in Cluny Museum, 233; varieties of, 227.
- Birch quoted, *note*, 82.
- Birds, with chariots, 97; as auguries, 96.
- Birotum, Roman, 147.
- Boadicea, opposes the Roman army, 249.
- Boguet, French, 244.
- Bonomi quoted, 73, 74; *note*, 79.
- Boonen, Wm., Q. Elizabeth, coachman of, 267.
- Botta, quoted, 69, 79, 84.
- Boyle on coach-riding, 307.
- Brewer's cart as moderator, 293; one-sided judgment of, 294; appeal from, 295.
- Bradford, Wm., *note*, 400.
- Braeck, French, 244.
- Brights and Blacks, factional, 335.
- Brouette, English, 324; French, 230.
- Brougham, English, 376.
- Buggy, American, 429; Bonner, 464; Carter's Newark, 436; cut-under, 446; gents' road, 457; Jenny Lind, 452; square, 453; top, 465.
- Bullock transit-wagon, Indian, 205.
- Batler, John, stage-wagon of, 404.
- Butterfly, weakness, typical of, 188.
- Byron quoted, 69.
- Cab, American, 443; Hansom's, 373, 385; Okey's quartobus, 379.

- Cabmen, dishonesty of, *note*, 386; enemy of, *ib.*; wages, 385.
 Cabriolet, American, 437, 458; Chinese, 201; Harvey's, 378; private, 369.
 Cadusians as Persian soldiers, 107.
 Cæsar in Britain, landing of, 248.
 Calash, Wm. Penn's, 399; Willing's, 407; American, 459.
 Caleche, French, 247; imported, 407, 457.
 Calosso, Neapolitan, 199.
 Caligula incensed, 163.
 Calgagns, chariots of, 249.
 Camillus, presumption of, 172.
 Campbell, William, first New York wheelwright, 402.
 Cappadocians levied by Persians, 107.
 Carceres, starting-point in the race, 126.
 Cariole, Norwegian, 392, 471.
 Carmen, New York, 398.
 Carriage, Gallic, oldest, 211; John Henry's, 412; wedding present of, 394.
 Carriage-builders' National Association, 467, 481.
 Carriage-makers in New York, 413, 420, 425.
 Carriage-making, Egyptian, 20.
 Carriage-part, frame-work of, 464.
 Carriages (American), Centennial, 475.
 Carriages (English), Centennial, 471.
 Carriages (French), Centennial, 468.
 Carriages, chronology of, *note*, 117; close, 216; costly, 231; country-made, 428; destructive to life, 248; duties on, 252; European, 210, 398, 404; forbidden to women, 211; forbidden, importation of, 411; Hungarian, 211; leasing of, 349; names of, 179; numerous in Naples, 198; ordnances for, 400; Parisian, 243; Philadelphian, 410; Roman and Grecian, 138; Spanish, 217; tax on, 417, 458, 459; use of, limited, 141; varieties of, 226, 230; why so called, 178.
 Carpenter, Abram, doggerel verse of, 403.
 Carpentum, why so called, 139; four-wheeled described, 140; forbidden to women, 141; used at weddings, 140.
 Carpentum Pompaticum, 141.
 Carroch, French, 226.
 Carroccio, captured from Florentines, 197.
 Carrosses, 216; body of, 232.
 Carruca, a Roman vehicle, 177; why so called, 150.
 Carrus, Roman, 148; differs from the plastrum, 152; used for liquids, 151; in Cæsar's army, 149.
 Carrus Clabularius, Roman, 152.
 Cart, Egyptian, baggage, 46; Elamitish, 91; Gujerat village, 204; Picardy, 218; pony, 456; Tartar, 208; mule, 90; ox, 90; usefulness of, 283; wheels of, 205.
 Carts, butcher's and grocer's, 442; Chinese, 200, 201; dignity of, 295; Indian, ruts of, 205; plain honesty of, 283.
 Cassivellanus, opposes Cæsar in Britain, 248.
 Catacombs, Egyptian, *note*, 21.
 Celtic fondness for horses, 255.
 Celsus quoted, 118.
 Centennial, American, 468.
 Centennial carriages, judges' report on, 475; Guiet's, 468.
 Central Park, view in, 396; *note*, 441, 459.
 Chair, 83, 419.
 Chairmen, unpleasantness among, 315.
 Chaise, American, 404; French, 229.
 Chaises, costs of, *note*, 430; London, 403; Pennsylvanian, 402, 403, 439; Staten Island, 411.
 Childeans, 91.
 Char-à-banc, 239.
 Chares, 258; ladies punished for using, 257; with the poets, 259.
 Chariclea, Dianian priestess, 112.
 Chariot, Abradatus's, 100; after Ginzrot, 99; appendage to, 73; British, in Rome, 255; britzscha, 263; Brown Willis's, 341; captured by Assyrians, 82; common, 228; composite, 367; costs of, 307; Earl Daruley's, 309; distinguished from the Egyptian, 82; Egyptian hunting, 50; Felton's, 341; grotesque, 194; in Florentine Museum, 57; making pole of, 66; O. Elliott's, 359; Pepys's mention of, 300; Queen Mary's, 263; rave of, 61; rimming wheel of, 65; Saxon, 254; state (Fr.), 216; tassels for, 73; trimming body of, 68; traveling, 366, 435; Trojan, 89; Vatican, 120; wabbling, 215; wheel of, 57, 61.
 Chariots, Egyptian, rope floors of, 33; Etruscan, 135; Mars the first to teach the art of making, 117; Grecian, on coins, 118; Minerva the inventor of, 117; open-sided, 34; ornamental, 42; Phrygians first to harness to, 117; Plato's description of, 119; Roman, names of, 158; racing, 161, 193.
 Chariot-race, Cynisca, 126; Democritus, 124, Philip, 125, victors in; Erichthonius first uses four horses in, 117; importance of, 124; Thucydides on, 125.
 Chariotee, 431.
 Charles, Earl Stanhope, inventions of, *note*, 361.
 Charon, fable of, 28.
 Charvolant, 365.
 Chancer quoted, 260.
 Child's carriage, 188.
 Circus, Roman, 163.
 Circus Maximus, *note*, 161; races in, 163; wild beasts, etc., 168.
 Cisium, why so called, *note*, 144; with deer team, 145; the gallant's carriage, 146.
 City Madam, Massinger's, 288.
 Claudius, 251.
 Clarence, 376; American, 458; Parker's, 440; three-quarter, 464.
 Clip king-bolt, Phelps's, 451; Reynolds's, 450.
 Cluny Museum, carriages in, 222, 233.
 Coach, etymology of the word, 211; *note*, 256; Archbishop Parker's, 267; basterna, 377;

- Beekman's, 408; bridal, 317, 394; cost of, 289; crane-neck, 337; first English railway, 363; for Continental travel, 463; Goold's drawing-room, 477; Lord Chancellor of Ireland's, 332; Montgomerie's, 401; Powell's 416; Queen Elizabeth's, 265, 266; Southern, 446; Washington's, 411; coach and carroach, *note*, 262.
- Coaches, annoyances of, 285, 288; best uses of, 287; crime caused by, 286; crane-neck, 337; deaf to good instruction, 281; death to saddlers, 278; destructive to ash-trees, 279; disgraceful to ride in, 268; engines of pride, 280; face ornaments, 296; for hooped ladies, 310; glass, 221; heirloom, 314; how utilized, 257; in Boston, *note*, 298; in Cluny, 221; in Philadelphia, 399, 419; in New York, 403; in Revolutionary times, 408; increase of, 297, 299; injurious to watermen, 278; introduction into England, 264; lame the owner's wife, 272; make costly leather, 277; opposed by watermen, 270; overthrow of, 289; pester the streets, 270; proposals to restrain, 269; rage for, 271; remedies proposed, against, 330; ruin shopkeepers, 299; sin-gentility, 269; St. Petersburg Museum, 392; Tattler on, 311; taxed, 316; twin-bodied, 219; un-mannerly, 285; wastefulness of, 283; worthlessness of, 285.
- Coach-makers, arms of, 306; in Albany, 421; in New York, 413, 420, 425; in Philadelphia, 411, 414; in England, number of, 374; patriotic, 415; societies, 306.
- Coach-making in Albany, 421; in Massachusetts, *note*, 417; in Revolutionary times, 413.
- Coach and harness makers in Philadelphia, 411.
- Coach-riding, Boyle on, 307.
- Coach and sedan, dispute of, 293.
- Coach and six, 273, 307, 314.
- Coach-springs, first New York maker of, *note*, 421.
- Coaches, C-spring, 434; Parker's, 441.
- Coachmen, drunken, 284; rascalities of, 320.
- Cochio, description of, 197.
- Cælius's leopards, present of, 167.
- Colden, Lieut.-Gov. Cadwallader, coach, burning of, 408.
- Colonial ordinances relating to carriages, 400.
- Corbillard, French, 224.
- Coryat, Tom, travels of, 218.
- Coupe, American, circular front, 462; English, 387; French, 242, 243.
- Covina, British, 250.
- Covinus, Gallican, 104.
- Cows at funerals, 24; Egyptian reverence for, *note*, 24; *æevis* horses, 203.
- Cremation, Roman, 173.
- Creusa, wife of Æneus, 131.
- Crier on scythe-chariots, 106.
- Cresus, 101; compelled his wives to travel at night, 111.
- Cromwell, *note*, 260.
- Cruelty of the Egyptians, 33, 37.
- Ctesius, in Nimus's army, scythe-chariots of, *note*, 98.
- Cummings, Alex., on wheels, 331.
- Cupid in character of charioteer, 186, 187, 191, 192.
- Curious mixture, 309.
- Curricie, American, 408; phaeton, 346; prop-er, 345; new pattern, 346.
- Curricles, Adams on, 346; gig, 317; improved, 354; Italian, origin of, 345.
- Curriculus, or child's carriage, 156.
- Curtius, Quintus, quoted, 98, 103, 111.
- Cypselus, chariot horse trainer, 124.
- Cyrenians, 99.
- Cyrus, against Sardis, expedition of, 98; old chariots, low estimate of, 99; makes new form of chariots, *note*, 73.
- Dabistan, reference to, *note*, 93.
- Damasippus, *note*, 140.
- Darius at Arbela, 107.
- Darius Hystaspes, *note*, 93.
- Dashour, wheel from, 57.
- Dean Swift on chairs, 317.
- Deane, E. and W., carriages, early importers of, 409.
- Demi-caleche, 242.
- Demi-landau, 462.
- Dennet, 371.
- Desobligeant, 228.
- Diana, car of, 190.
- Dickey-seat, first appearance of, 308.
- Didymus, of Alexandria, 78.
- Diodorus Siculus quoted, *note*, 17, 43, 53.
- Diomedes, spoiler of Rhesus, 97.
- Diomedes, wronged by Alcibiades, 125.
- Diphron, 105, 118.
- Dog-cart, 240; shamrock, 381.
- Domitius, skilled chariot-driver, 128.
- Double Stanhope, 436.
- Douceurs, whips receivers of, 335.
- Drag, description of, 473; Hooper & Co.'s, 472; in New York, 281.
- Drasina, Gompertz's, 466.
- Dressing tails of horses, 87.
- Droschke, Russian, 390.
- Duke of Queensbury duped by his footman, 314.
- Du Simitière, P., *note*, 410.
- Earl of Rutland, English coach of, 265.
- Eccentricities of gentlemen, 333.
- Egypt, magnificence of, 20; mechanism, 20, 64; founding of, 21; funerals of, 21; events recorded of, *note*, 20.
- Egyptians in the army of Croesus, 101.
- Elamites, carts of, 90.
- Elegy on death of trade, 309.
- Emergard, flight of, 211.
- Emperors as charioteers, 165.
- English pleasure-carriages, *note*, 98; love of display, 389.

- Eos, goddess, 129.
 Epicurean picture, 195.
 Erichthonius, first to ride in chariots, 116.
 Esseda, British, 250.
 Essedum, Ginzrot's, 252; Pownall on, 251.
 Ethiopia, hunting in, 50, 77.
 Etruria, mythology of, 95.
 Etruscan chariots, 135
 Eunuchs as chariot-drivers, 81.
 Evelyn's diary, 258.
 Express-wagon, 442.
- Factions, how divided, 163; Virgil on, 162.
 Fairholt on British chariots, 254.
 Farmer's cart, Persian, 115.
 Felton, William, treatise on carriages and harness, 334.
 Ferry, New York to Brooklyn, *note*, 422.
 Fiacles, why so called, 220; in Paris, 219.
 Flying-coaches, 300; endanger life, 330.
 Flying-machines, 406; a Frenchman's description of, 328.
 Footmen, origin of, 314.
 Ford, Isaac, improvements of, 441.
 Frederick II enters Padua, 196.
 Friction annihilated, 319.
 Froissart, quotation from, *note*, 263.
 Funeral cortege, Egyptian, 24, 25; customs, 23; procession, 28.
 Funerals, prize-fights at, 168; Roman, 173.
- Galen as Priam from Pergamus, 131.
 Gaulic manner of fighting, 210.
 Gay, on London streets, 313.
 Geber fragments, *note*, 93.
 Germantown, 423, 445.
 Getting Parisian drafts-man, 433.
 Gig, American, 430; English, 317, 319, 371.
 Glass panels, 218; windows for coaches, 231, 299.
 Gould, James, 422.
 Goat chariots, 191, 192.
 Green and Dockura's invention, 320.
 Greece, 95; settlement of, *note*, 116.
 Grecian and Etruscan painted vases, 97.
 Grecian lady's chariot, 135.
 Griffin, in harness, 187; sacred to the sun, 188.
- Hack, South Boston, 433.
 Hack-chaises, 402, 403; New York, fares of, 414.
 Hack-coach, John Clapp's, 400.
 Hack-vehicles, Neapolitan, 198.
 Hackney-coaches, Capt Bailey's, 288; first in London, 287; fraudulent petition against, 297; meaning of the term, *note*, 287; numbers of, 292, 297; restrictions on, 287.
 Hages attacks Alexander, 107.
 Hallet, James, New York wheelwright, 403.
 Hammock carriage, Anglo-Saxon, 255.
 Hansom-cab, 373; Evans, 388.
 Harma, Persian war-chariot, 100.
- Harmamaza Persian, ladies' carriage, 111; used for beds, 110.
 Harness, Assyrian, 77; Egyptian, 37; harness carriage makers, 335.
 Harvey's cabriolet, 378.
 Hearse, Alexander's, 113; Cunningham's, 477.
 Hebrews, nations, naming of, *note*, 116.
 Hecca, Indian, 203.
 Hector, Achilles to, petition of, 131.
 Hel-carts, 285.
 Heliodorus, quoted, 112.
 Henry IV, assassination of, 284.
 Herculeanum, destruction of, 185.
 Herodotus, quoted, 22, 93, 117; *note*, 24, 43, 53.
 Hesiod, chariots, description of, 134.
 Hezekiah, Sennacherib, threats of, 85.
 Hieronymus, builder of Alexander's funeral car, 114.
 Hoby, Sir T., tenders his coach to Lady Cecil, 265.
 Hobson, Tobias, Milton on, *note*, 268; supplies horses to students, 268.
 Hoefnagel, print of coaches, 267.
 Holstein-vogue, Danish, 394.
 Homer, *note*, 98; hymn to Venus, 116; on chariots, 113, 119, 124, 132; furnishes painters subjects, 129; quoted, 17.
 Hooked chariots, Arian, *note*, 101.
 Horse, care in selection of, 284; Egyptian, beauty of, 63; blankets and harness of, 37.
 Horse fanciers, American, 402.
 Horses, Chinese, 200; governmental supply of, 368; Grecian names of, 120; guided by staff, 130; Egyptian head-dress of, 87; manner of yoking, 120; of business, for pleasure riding, 407; cut-tailed, 234.
 Horseback riding, 215, 217.
 Horse-litter, 213; accident to, 299; deemed effeminate, 214; English, 258; Markland on, 262; of early colonists, 398.
 Horse posts, 401.
 Household book, Kyston, 267; Northumberland, 263.
 Hub, quoted, 81.
 Hyde Park, police action in, 389.
- Idlers, notice to, *note*, 195
 Iphigenia, sacrifice of, 190.
 Isabella, entrance to Paris, 213.
 Isocrates, his defence of Alcibiades, 125.
- Jack-of-all-trades, *note*, 401.
 Jaunting-car, 354.
 Jefferson, Thomas, carriage of, 421.
 Jenny Lind buggy, 452; volant, 427.
 Jin-eik-sha, Japanese, 203.
 Josephus, *note*, 70.
- Karen, German, 394.
 Karnak, 82; ruins of, *note*, 20; victories recorded at, 31.
 Ker Porter, Sir Robert, among the ruins of Persepolis, 93.

- Khorsabad, 72.
 Khosrovah farmers' cart, 115.
 Kibitka, Russian, 392.
 Kouyunjik, 72, 81, 90.
 Kouyunjik Tepè, mounds of, 84.
- Lachish, Sennacherib before, 85.
 Landau, American, *note*, 428, 465; English, 338; Elcho sociable, 389; French single-horse, 246.
 Landulet, English, 340; French, 242, 469.
 Layard, *note*, 69, 73, 98.
 Leasing carriages, 394; *note*, 350.
 Lectica, early use of, 138.
 Le Clerc, on Curtius, 101, 104.
 Libyans, 107.
 Lion hunting, 77.
 Litters, 211, 396; prejudice against, 214.
 Liveries of coachmen and sedan-bearers, 293.
 Livy, 103; on scythed-chariots, 109.
 Lohner system, 474.
 Locust, affection's representative, 185.
 London, carriages of, 382, 388; great fire in, *note*, 298; street scene, 378.
 London exhibitions, reports of, 380, 382.
 Long wagons, 261; passenger, 305.
 Longchamps, carriages on, 244.
 Lord Mayor's London coach, 323; show, 322.
 Louvre, Assyrian art in, 64.
 Love, as charioteer, 190; funeral car of, 185.
 Lucan on lions, 78.
 Lucian on Cupid, 186.
 Luxor, Temple of, 19; victories recorded at, 54; ruins of, *note*, 53.
 Lyons collection, 95.
 Lyons, Duke of, 95.
 Lysistrata, 112.
- Macæna's advice to Augustus, 164.
 Maffei on bass-reliefs, 165.
 Magasin Pittoresque, quotation, 97.
 Mail-coaches, *note*, 322.
 Mail-phaeton, 372.
 Mail-stages, American, 423, 424.
 Manetho, fragment of, 70.
 Marcellinus Ammianus quoted, 21.
 Maria of Anjou, chariot of, 215.
 Mars, as chariot-driver, 132; teacher of chariot-making, 116.
 Maximilian, triumph of, *note*, 256.
 Mears's picture of Philadelphia, *note*, 417.
 Medénet Habou, *note*, 43.
 Medes, 99, 107.
 Media, *note*, 93.
 Memnon, son of Tithon, 89.
 Menepthah I, victories of, 31, 35.
 Menepthah II, 42.
 Menepthah III, march after victory, 42; against an enemy, 44; victories in Africa, 43; visits temple of Amun, 46.
 Mesopotamia, Egyptian captives of, 90.
 Messalina, illegal riding of, 142.
 Milligen on Grecian vases, 130.
- Minerva, chariot of, 189.
 Monachus, Roman, from a tomb, 146.
 Monalos, 461.
 Monocycle, Hamond's, 237.
 Monuments of notable events, *note*, 122.
 Morrison, Fyne, in England, 271.
 Mounting the state coachman, 327.
 Mourners, Egyptian, 22, 24.
 Murray, Robert, coach of, 408.
 Musical carts, Japanese, 203; Tartar, 209.
 Mule-team, 90; harness of, 91; party at rest, 92.
 Mykerinus, Pharaoh, in British Museum, body of, *note*, 29.
 Mylords, varieties of, 245.
 Myrmecides, small carriage of, 182.
 Myrtilus, the faithless charioteer, 122.
- Nero drives through a wall, 164.
 Nestor introduced chariot-driving, 125.
 New England, early wheelwrights of, 397.
 New York Coach-maker's Magazine, 110.
 New-Yorkers, winter diversions of, 401; in summer, 404.
 Niebuhr, bass-reliefs from, 94.
 Nile, *note*, 17.
 Nimrod, 69; *note*, 93.
 Nimroud, 72, 79, 89.
 Nineveh, crowded with chariots, *note*, 69; ruins of, 69.
 Ninus, 98.
 Nomenclature, English, carriage, 380; Russian, 390.
 Normans' chares, inventors of, 258; expert in horsemanship, 257.
 Numidians as couriers, 138.
- Odometers, Roman, 181.
 Enomaus' race beaten, 122.
 Olympic games, chariot-races in, 124; instituted by Jupiter and Hercules, 122.
 Omnibus, American, 437, 460; Chinese, 202; English, 370; French, 220; gentleman's family, 386; hackmen's opposition to, 370; in embryo, 230; naughty drivers of the, 439.
 Orbis Sensualium Pictus, 288.
 Ordinances, aldermanic, 400.
 Osiris, 27, 29.
 Ostrussen I, *note*, 20.
 Overend, Henry, inventions of, 334.
 Ovid, extract from, 185.
 Oxen, funeral use of, 27.
- Palanquin, Indian, 203.
 Panthea, wife of Abradatus, 100.
 Papyrus deeds, 26.
 Patents, Avril's, 236; Elliott's, 359; Grobert's, 235; Leclercq & Crombette's, 235; Simon's, 233; Teller's, 237.
 Panc-wheels, why so called, *note*, 19.
 Pausanias on Grecian trophies, 120.
 Pegge, Rev. Samuel, on *essedas*, 252.

- Pegma, 152.
 Perch, why so called, 312.
 Perch-coupling, Everett's, 447; Hautsknecht's, worthless, 448, 449; occasion wrong, 450.
 Persepolis idol-car, 98; ruins of, 93.
 Persens in disgrace, 170.
 Persian Empire, out of Assyrian, 93; sculptures, 81.
 Persians confine their wives in close carriages, 112; believe in auguries, 98.
 Phaetons, *American*, canoe, 461; dickey-seat, 435; gig, 461; physician's, 452; pony, 456; turn-over seat, 443; slat-sided, 431.
 Phaetons, *English*, 391; high-flier, 325, 342; crane-neck and perch-high, 342; pony, 342; pony-berlin, 343; shooting, 343; sporting, 381; Victoria, 377; Peters & Son's, 472.
 Phaetons, *French*, 245; lady's, 223.
 Pharnaces at Ziela, 109.
 Phradates, leader of the Caspians, 107.
 Piletum, why so called, 142.
 Plato quoted, 89.
 Plaustrum, 56, 152, 155; Egyptian, 56; Italian, 194; Roman, 152, 155; four-wheeled, 156.
 Pliny quoted, 351.
 Plostellum, Italian, 188; Roman, 156.
 Pompé, French, 247.
 Pompeii, destruction of, 183.
 Pony-cart, 456.
 Portland vase, chariots from, 131.
 Porus, scythe-chariots of, 107, 108.
 Postilions, why instituted, 216.
 Praise, Egyptian, prohibited, 22.
 Priests, Egyptian, high honors of, 24.
 Priam, king of Troy, 89, 131.
 Post-chariot, English, 353, 367.
 Post-chaise, 341, 363; first builder of, *note*, 322; first use of, 398.
 Post-horses, English, 271.
 Post-routes, American, 399, 401, 406, 418.
 Prince George of Denmark, road adventures of, 310.
 Producers, Mrs. G., the cabmen's foe, 386.
 Quadriga, racing, 165.
 Quaker chaises, 349.
 Queen Anne, procession of, 311; Eleanor, *note*, 264; Elizabeth, coaches of, 265, 267; her procession to Westminster, 264.
 Quick, A., forfeits a gig, 426; calls country carriage-makers thieves, 229.
 Quiver, Assyrian, 81.
 Raderus, Matthæus, 102, 105.
 Rain in Egypt, scarcity of, *note*, 55.
 Rameses II (Sesostris?), 21; victories of, 36, 38.
 Rameses III, 40; dishonors his victims, 53; victories of, 39.
 Rameses IV, African lion-hunt of, 51; visits the temple of Amun, 52.
 Rawlinson quoted, 89.
 Repositories, institution of, 428; selling vamped-up carriages, 351, 358.
 Religion as practiced in Egypt, *note*, 22.
 Rhedas, family, post and state, 175.
 Rhesus, Diomedé, spoils of, 97.
 Rippon, Walter, coach-maker to Queen Elizabeth, 265.
 Roads, Appian and Flaminian, 138; anecdote of, 199; Pompeian, 196; Sequanian, 151; ill condition, 385.
 Rockaway, 445; cut-under, 460; Fenton, 456; six-seat, 457; six-seat coupé, 463.
 Rockaway, Germantown, 423, 445.
 Rome, carriages on the road, 138; how settled, *note*, 137; triumphs of, 95.
 Ross, Daniel, early carriage-builder, 419.
 Rossellini, 31, 39.
 Rot-u-n, chariot of, 55.
 Roubo on French carriages, 219.
 Royalty, accommodation for, 83.
 Roxberge Ballads, extract from, 289.
 Sand for bread, 164.
 Savage, Nicholas, introduction of hacks into Paris by, 219; Schliemann at Mycenæ, 135.
 Scotland, introduction of chairs into, *note*, 318.
 Scroll-spring improvements, 463.
 Scythian funeral customs, 209; movable dwellings, 207; punishment of false prophets, 208.
 Scythe-chariots, Abradatus's, 100; Cyrus's, *ib.*; Drakenborch on, 106; insufficiency of, 101; old form of, 99; Xenophon on, 90; Stechevins on, 105.
 Sedan, Mexican, captured, *note*, 397.
 Sedans advocated, 291; Chinese, 200; Neapolitan, 197; Sir S. Dunscombe's, 293; waning favor of, 373.
 Sedan-cart, 315.
 Sedan-chairs, 317.
 Sennacherib, invades Judea, 85, 92.
 Sesostris, 70.
 Severus, Alex., despises scythe-chariots, 110.
 Shaffer, John, defends Curtius, 102.
 Shakespeare, as holder of horses, *note*, 268.
 Shoemaker, Miss, recollections, 407.
 Sidney, Sir H., the defiant trumpet-blower, 269.
 Sigismund, John, large owner of carriages, 216.
 Skelton, 260; chaise of, 402.
 Sledge-hearse, funeral, 23, 25, 27.
 Sledge, primitive, 18; McGowan's, 412.
 Sledge-wagon, primitive, 19.
 Sleigh, Cluny, 223; Goolds, 423; New England, 422.
 Smuggling, story of, 238.
 Sociable, American, 432; English, 344.
 Solomon imports horses from Egypt, 62.
 Spanish princess, wedding coach of, 218.
 Sophocles, on chariot-races, 128.
 Spenser quoted, *note*, 269.
 Springs, early manufacture of, American, *note*, 421; early allusion to, 298; Sprout's, 453.

- Squire of low degree, 259.
 Stage-coaches, *American*, 424; to Annapolis, 405; to Bordentown, *ib.*; to Boston, 399, 410; to Philadelphia, 401, 404, 406; to Western New York, 418, 425.
 Stage-coaches, *English*, early use of, 271, 278; baggage-rack of, 271; basket of, 321; Hogarth's *ib.*, time made by, 324; opposition to, 301, 304, 319, 320; more dangerous than steamboats, 369.
 Stage-drivers, 424; meet to mourn over loss of occupation, 425.
 Stanhope, *English*, 326.
 State show, *English*, 328.
 Statins on parrots, 185.
 Statistics of carriages, 446; of trade, 467.
 Strabo, allusion to, 56.
 Street-car, *American*, 439; *English*, 364.
 Street obstructions, 329.
 Strutt on esseduns, 253.
 Suetonius on esseduns, *note*, 251.
 Sulky, *American*; 437, 453; *English*, 341.
 Sumeanah-a-Doulah, vizier of Persia, *note*, 94.
 Sun-curtains, early appearance of, 308.
 Susianian spoils, 90.
 Swan-car, *Pompeian*, 186.
 Sweden, first carriage in, 394.
 Sword-case, 433.
 Syctale, Aristotle's, 19.
- Talashka, *Russian*, 390.
 Tandem driving, 241.
 Tapissière, 240.
 Tarenta, *Russian*, 292.
 Tartar mechanism, poverty of, 209.
 Taylor, John, *note*, 248; World on Wheels of, 273.
 Team, illy matched, 187.
 Teams, *Roman*, 168, 169.
 Telega, *Russian*, 390.
 Telegraph-buggy, 357.
 Thebes, *note*, 17.
 Thensa, Adams on, 178; *Roman*, 178.
 Theocritus, quoted, *note*, 63.
 Theodosian code, 177.
 Tholmes III, bass-reliefs of, 65.
 Tiberius, scourges his cohort, 138.
 Tigris, 69.
 Tilbury, 361.
 Tithon, Persia, governor of, *note*, 89.
 Tokkari, carts of, 38.
 Town-chariot, 339.
 Town-coach, 336.
 Trade, *English*, 382; in the eighteenth century, 344; Parisian ruiniers of, 243; Scottish, 384; tricks of, 350, 358.
 Trappings for horses, *Egyptian*, 37; *Persian*, 95.
 Travel, difficulties of, 411; early mode of, 18; in England, 305, 310; in New York, 418.
 Traveling coach, 337; *American*, 434.
- Triplet, Avril's, 236.
 Triumphal procession for P. Æmilias, 169; for Titus, 172.
 Troy in alliance with Assyria, 89.
 Trojan chariots, Xenophon on, 98.
 Tu quoque quoted, 260.
 Tympanum wheels, 194.
 Tyrris Maximus quoted, 111.
- Umbrella sociale, 344.
 Umbrellas introduced into England, 333.
- Van Berg, Sir Christopher, inventions of, 296.
 Van Dam, Rip, imports a horse, *note*, 402.
 Velocipedes, 466.
 Venus, chariot of, 186.
 Vespasian, narrow escape of, 163.
 Vesuvius, eruption of, *note*, 183.
 Victory, goddess of, 184; procession in honor of, 35.
 Virgil, in chariot-race, 166; quoted, 28, 63.
 Vitellius, charioteers, fancy for, 165; on factions, 163.
 Vis-à-vis, *English*, 338, 349; *French*, 239.
 Volante, *Spanish*, 427.
- War-chariot, *British*, 158; despised by Roman soldiers, 157.
 Wagon, business, 444; Concord, 455; country, express, 442; Gettson's, 444; grocers', 442; Meriden, 415; New Rochelle, 455.
 Wagon and funeral boat, *Egyptian*, 29.
 Wagonette, *English*, 383.
 War-chariot, 42; timber bent for, 66.
 Wheel, *Egyptian*, 57, 60; wood tire of *British*, found on Hamden Hill, fragment of, 253; iron, 82; Oliver's, 453; *Egyptian*, wood tire of, 59.
 Wheeled beds, *note*, 256.
 Wheels used as spits, 209; rough-shod, 95.
 Wheel-ruts, in Greece, 117; in Pompeii, 196.
 Wheelwrights, *American*, 397, 410, 414, 422.
 Whips, *Egyptian*, 33.
 Whirlicote, for the sick, use of, 260.
 Whisky, caned, 348; grasshopper-chaise, 348; curricie, 349.
 Wild beasts, taming of, 168.
 Wilkinson, Sir G., Ancient Egyptians of, quoted, *note*, 25, 33; *note*, 45, 48, 50; *note*, 63.
 Wine merchant, wagon of, 195.
 Worcester, Marquis of, his inventions, *note*, 297.
- Xenophon, quoted, *note*, 73; on Cyrus's offering, *note*, 98; on Trojan chariots, *ib.*
- Yokes, *Egyptian*, 38; emblematical of submission, 160.
- Ziela, town of, 109.
 Zohawk, Assyrian tyrant, *note*, 93.





